

Catálogo

Perfis Extrudados de Alumínio



1ª Edição
Janeiro/2024

DESCONSIDERAR EDIÇÕES ANTERIORES

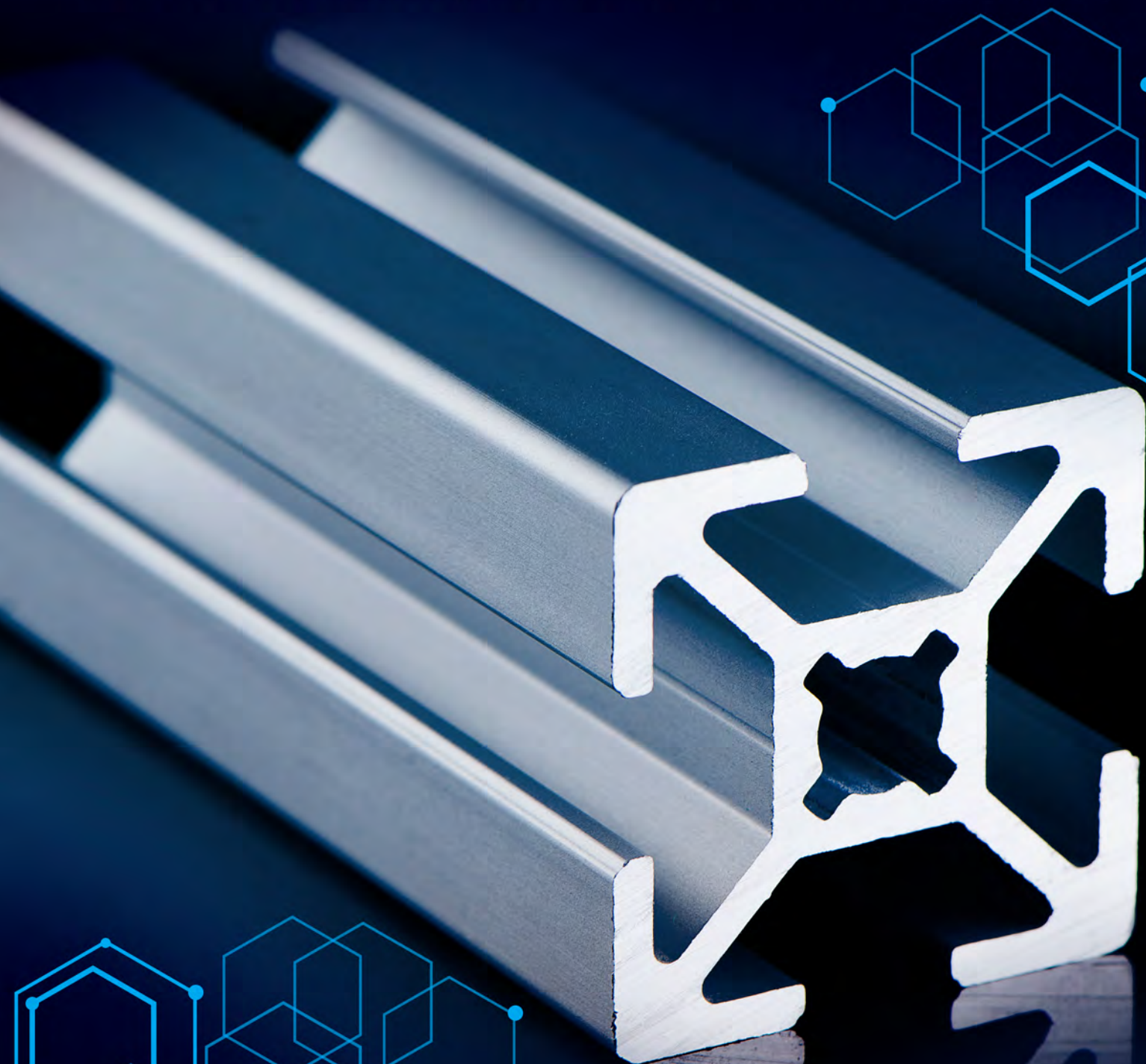

extrutech alumínio

extrutech.com.br





extrutech alumínio

SOBRE NÓS

Possuímos soluções que se encaixam nas mais diversas necessidades e perfis de negócios. Além disso, desenvolvemos projetos sob medida para nossos clientes.



Soluções que combinam eficiência e estética que você procura com a competitividade que você deseja. Atuamos no setor da construção civil e indústria. Completo estoque de perfis de alumínio e acessórios em geral, das principais linhas do mercado.



www.extrutech.com.br

UMA EMPRESA INOVADORA



Acompanhando sempre a evolução da tecnologia, nossos equipamentos são modernos e com recursos que otimizam todo o processo.

Fornecemos produtos de excelente qualidade, com custos competitivos e com suporte aos mais variados segmentos do mercado. Além da infraestrutura física, dispomos de um corpo técnico especializado para análises técnicas e desenvolvimentos de ferramentas e peças que exigem minuciosidade em cada detalhe dimensional, desde perfis pequenos até os projetos de maior escala.



extrutech alumínio

Propriedades Físicas

Liga	Peso Específico (g/cm ³)	Módulo de Elasticidade MPa	Módulo de Rigidez MPa	Temperatura de Fusão (°C)	Calor Específico (0-100°C) & DOJ (°C)	Coefficiente de Expansão Linear (L/°C)	Condutibilidade Térmica (25°) (Cal./cm ² C)	Condutibilidade Elétrica (ACS)%
1050	2.70	70000	26500	650-660	0.22	24x10 ⁻⁶	0.50	60.0
3003	2.73	70000	26500	640-655	0.22	23x10 ⁻⁶	0.38	43.0
5052	2.68	72000	27500	595-650	0.23	23x10 ⁻⁶	0.33	34.0
6005	2.71	70000	26500	580-650	0.22	24x10 ⁻⁶	0.37	40.0
6060	2.71	70000	26500	600-650	0.21	23x10 ⁻⁶	0.48	52.0
6061	2.71	70000	26500	580-650	0.22	24x10 ⁻⁶	0.37	40.0
6063	2.71	70000	26500	600-650	0.21	23x10 ⁻⁶	0.48	52.0
6082	2.71	70000	26500	555-650	0.21	24x10 ⁻⁶	0.44	45.5
6101	2.71	70000	26500	605-655	0.22	23x10 ⁻⁶	0.49	55.0
6261	2.71	70000	26000	570-655	0.22	23x10 ⁻⁶	0.44	47.0
6262	2.71	70000	26700	582-652	0.21	23x10 ⁻⁶	0.37	44.0
6351	2.71	70000	26500	555-650	0.21	24x10 ⁻⁶	0.44	45.5
6463	2.71	70000	26500	600-650	0.21	23x10 ⁻⁶	0.48	52.0
7075	2.80	73000	27500	475-630	0.23	24x10 ⁻⁶	0.29	30.0

Características Específicas

Liga	Resistência à corrosão	Anodização Decorativa	Anodização Protetora	Solda MIG	Solda TIG	Usinagem	Deform. à frio	Brasagem	Outras
1050	A	A	A	A	A	E	A	A	
3003	A	D	B	A	A	D	A	A	
5052	A	A	A	A	A	C	A	B	
6005	A	D	A	A	A	D	B	A	
6060	A	A	A	A	A	D	B	A	
6061	A	D	A	A	A	D	B	A	
6063	A	A	A	A	A	D	B	A	
6082	A	D	A	A	A	C	C	C	
6101	A	A	A	A	A	D	B	A	
6261	A	C	A	A	A	C	C	B	
6262	B	C	A	A	A	A	C	A	
6351	A	D	A	A	A	C	C	C	
6463	A	A	A	A	A	D	B	A	
7075	C	E	B	N	N	D	B	N	Solda por resistênci

Composição Química(%peso)

Liga	Al	Si	Fe	Cu	Mn	Mg	Cr	Zn	Ti	Outros	
										CADA	TOTAL
1050	99.50	0.25	0.40	0.05	0.05	0.05	-	0.05	0.03	0.03	-
3003	-	-	-	0.05	1.0	-	-	-	-	-	-
	-	0.6	0.7	0.20	1.5	-	-	0.10	-	0.05	0.15
5052	-	-	-	-	-	2.2	0.15	-	-	-	-
	-	0.25	0.40	0.10	0.10	2.8	0.35	0.10	-	0.05	0.15
6005	-	0.6	-	-	-	0.4	-	-	-	-	-
	-	0.9	0.35	0.10	0.10	0.6	0.10	0.10	0.10	0.05	0.15
6005 A	-	0.5	-	-	-	0.4	-	-	-	-	-
	-	0.9	0.35	0.30	0.50	0.7	0.30	0.20	0.10	0.05	0.15
6060	-	0.30	0.10	-	-	0.35	-	-	-	-	-
	-	0.60	0.30	0.10	0.10	0.60	0.05	0.10	0.10	0.05	0.15
6061	-	0.40	-	0.15	-	0.8	0.04	-	-	-	-
	-	0.8	0.7	0.40	0.15	1.2	0.35	0.25	0.15	0.05	0.15
6063	-	0.20	-	-	-	0.45	-	-	-	-	-
	-	0.60	0.35	0.10	0.10	0.9	0.10	0.10	0.10	0.05	0.15
6082	-	0.7	-	-	0.4	0.6	-	-	-	-	-
	-	1.3	0.5	0.10	1.0	1.2	0.25	0.20	0.10	0.05	0.15
6261	-	0.40	-	0.15	1.0	0.6	-	-	-	-	-
	-	0.7	0.40	0.40	0.35	1.2	0.25	0.20	0.10	0.05	0.15
6262	-	0.40	-	0.15	-	0.8	0.04	-	-	-	-
	-	0.8	0.7	0.40	0.15	1.2	0.14	0.25	0.15	0.05	0.15
6351	-	0.7	-	-	0.40	0.40	-	-	-	-	-
	-	1.3	0.50	0.10	0.8	0.8	-	0.20	0.20	0.05	0.15
6463	-	0.30	-	0.05	-	0.35	-	-	0.01	-	-
	-	0.60	0.15	0.20	0.05	0.65	-	0.03	0.03	0.05	0.15
7075	-	-	-	1.2	-	2.1	0.18	5.1	-	-	-
	-	0.40	0.50	2.0	0.30	2.9	0.28	6.1	0.20	0.05	0.15

Apresenta em sua composição Pb = 0.20-0.60% e Bi = 0.20-0.60% Apresenta em sua composição Pb = 0.40-0.70% e Bi = 0.40-0.70% Boro 0,05% máximo



extrutech alumínio

ESPECIFICAÇÕES TÉCNICAS

Característica e Aplicação

1050	Baixa resistência mecânica, alta resistência à corrosão, boa conformabilidade, fácil de soldar, apropriada para anodização decorativa.	Indústria química, farmacêutica e alimentícia; utensílios domésticos. Refrigeração (trocadores de calor em geral).
3003	Média resistência mecânica, alta resistência à corrosão, boa conformabilidade, boa soldabilidade.	Tubos para trocadores de calor (radiadores automotivos). Antenas.
5052	Boa resistência mecânica, alta resistência à corrosão, boa conformabilidade.	Vergalhões para rebites, transporte e equipamentos.
6005 A	Boa resistência mecânica, alta resistência à corrosão, boa conformabilidade, e média usinabilidade.	Rodas e acessórios de bicicletas esportivas e motocicletas, náutica e transporte em geral.
6060	Média resistência mecânica, alta resistência à corrosão, boa conformabilidade.	Perfis para construção civil, caixilharia em geral, tubos de irrigação, móveis e iluminação.
6061	Boa resistência mecânica, boa resistência à corrosão, boa conformabilidade. Média usinabilidade.	Estruturas, construção naval, veículos e rebites. Indústria moveleira.
6063	Apropriada para anodização decorativa fosca.	Móveis e Iluminação.
6101	Alta condutividade elétrica, média resistência mecânica, boa resistência à corrosão.	Liga especial para fins elétricos e barramentos (estruturas).
6261	Boa resistência mecânica, boa resistência à corrosão, boa conformabilidade. Média usinabilidade.	Carrocerias de veículos, estruturas e equipamentos.
6262	Ótima usinabilidade, alta resistência mecânica, alta resistência à corrosão, apropriada para anodização decorativa.	Peças usinadas em torno automático. Excelente alternativa para o latão de corte livre.
6351	Boa resistência mecânica, alta resistência à corrosão, boa conformabilidade, média usinabilidade.	Engenharia estrutural, construção de navios, veículos e equipamentos. Peças usinadas em tornos não automáticos. Forjamento a frio.
6463	Média resistência mecânica, boa resistência à corrosão, boa conformabilidade apropriada para anodização decorativa de alto brilho.	Painéis e frisos para eletrodomésticos, automóveis e armários.
7075	Os mais altos valores de resistência mecânica, média resistência à corrosão, boa forjabilidade e usinabilidade.	Peças sujeitas aos mais altos esforços mecânicos em indústria aeronáutica, militar, máquinas e equipamentos. Moldes para injeção de plástico.

Propriedade Mecânica

Liga	Têmpera	Limite de Resistência à Tração MPa	Limite Convencional de escoamento MPa	Limite de Resistência ao Cisalhamento (MPa)	% de Alongamento em 50mm	Dureza Brinell 2,5/62,5
1050	O	95 (80)	- (30)	(62)	25	-
	H14	85 (100)	70 (80)	(72)	-	-
	H18	110 (130)	90 (100)	(76)	-	-
3003	O	130 (120)	- -	(76)	25	-
	H12	115 (140)	- -	-	-	-
	H14	140 (151)	- -	(97)	-	-
	H16	165 -	- -	(103)	-	-
	H18	185 -	- -	(110)	-	-
5052	O	220 (209)	- -	(123)	25	-
	H32	215 (227)	160 (183)	-	-	-
	H34	233 (260)	180 (235)	(144)	-	-
	H36	255 -	200 (250)	(165)	-	-
	H38	270 -	- -	(165)	-	-
6005 A	T6F	260 (270)	215 (230)	-	10	82
6060	O	130 (125)	- -	(76)	18	-
6061	O	150 -	110 -	(82)	16	-
	T4	180 (211)	110 (129)	(165)	16	-
	T6	260 (309)	240 (280)	(206)	8	(102)
	T6*	290 (351)	240 (332)	-	10	(105)
	T8	- (368)	- (348)	(100)	-	-
	T89	370 -	325 -	-	-	-
6063	T4A	110 (145)	60 (79)	(98)	-	-
6101	O	- (137)	- (82)	-	-	-
	T6	200 (230)	172 (213)	-	-	-
6261	T4A	157 (186)	83 (108)	-	-	-
	T4	181 (199)	98 (123)	-	-	-
	T6C	229 (280)	199 (248)	-	10	(90)
	T6	260 (309)	240 (280)	-	8	(102)
6262	T6	260 -	- -	-	10	-
	T9	360 (390)	330 (370)	-	5	(111)
6351	T4	220 (227)	130 (121)	(152)	16	(64)
	T6	290 (315)	255 (288)	(201)	8	(106)
6463	T5	150 (219)	110 (189)	(118)	8	66
	T6C	180 (226)	150 (197)	(135)	-	-
	T^	205 (235)	170 (213)	-	8	-
7075	O	275 -	165 -	-	-	-
	T6	560 (630)	495 (608)	(329)	-	(150)



extrutech alumínio

ESPECIFICAÇÕES TÉCNICAS

Espessura de Parede

Tubos Quadrados, Sextavados, Retangulares e Sextavados

Espessura nominal da parede(mm)	 Desvio permitido da espessura média AA+BB/2 em relação a espessura nominal		 Desvio permitido da espessura em qualquer ponto em relação à espessura média (excentricidade) (+/- mm)	
	DCC (Diâmetro do Círculo Circunscrito em mm)			
	Menor que 127	Maior que 127	Menor que 127	Maior que 127
Até 1,19	0,13	0,20	0,13	10% da espessura média da parede máx:1,52 mín:0,25
1,20 a 1,55	0,15	0,23	0,18	
1,56 a 1,95	0,18	0,25	0,25	
1,96 a 3,15	0,18	0,25	0,25	
3,16 a 6,34	0,20	0,38	0,36	
6,35 a 9,51	0,28	0,51	0,63	
9,52 a 12,69	0,36	0,76	0,76	
12,7 a 19,04	0,63	1,02	1,02	

Espessura de Parede

Tubos Redondos

Espessura nominal da parede(mm)	 Desvio permitido da espessura média AA+BB/2 em relação à espessura nominal (+/- mm)				 Desvio permitido da espessura em qualquer ponto em relação a espessura média (+ mm)
	DCC (Diâmetro do Círculo Circunscrito em mm)				
	Até 31,75	Até 31,76 a 76,19	76,20 a 126,99	acima de 127	
Até 1,19	0,15	-	-	-	10% da espessura média Máx:1,52 Mín:0,25
1,20 a 1,55	0,18	0,200	0,20	0,25	
1,56 a 1,95	0,20	0,200	0,23	0,30	
1,96 a 3,15	0,23	0,230	0,25	0,38	
3,16 a 6,34	0,23	0,230	0,33	0,51	
6,35 a 9,51	0,28	0,280	0,41	0,63	
9,52 a 12,69	-	0,380	0,53	0,89	
12,7 a 19,04	-	0,510	0,71	1,14	

Altura e Largura

Tubos Quadrados, Sextavados, Retangulares e Sextavados

Espessura nominal da parede(mm)	Nos Cantos	Em lados Opostos(1)	
	 Tubos Quadrados e Retangulares	 Tubos Quadrados Sextavados e Oitavados	Tubos Retangulares
Desvio permitido da altura (ou) largura em relação à dimensão nominal (+/- mm)			
Tubos Extrudados			
12,70 a 19,05	0,30	0,51	
19,06 a 25,40	0,36	0,51	
25,41 a 50,80	0,46	0,63	
50,81 a 101,60	0,63	0,89	
101,61 a 126,70	0,89	1,14	
126,71 a 152,40	1,14	1,40	
A tolerância para a largura é o valor da tolerância para uma dimensão igual à altura, e inversamente, mas em nenhum caso esta tolerância é menor for menor do que nos cantos (2)			

(1) Não aplicável em tempera 0, tubos em rolos ou tubos cuja espessura de parede for inferior a 0,5mm ou 2,5% do diâmetro externo da circunferência equivalente (diâmetro do círculo cuja circunferência mede o perímetro do tubo).

(2) E x.: em um tubo retangular extrudado de 76,20 x 38,10 mm, a tolerância na largura (76,20) é de +/- 0,63 mm e na altura (38,10), é de +/- 0,89 mm.



extrutech alumínio

ESPECIFICAÇÕES TÉCNICAS

Tolerâncias na seção transversal

Em dimensões de metal			Dimensões entre superfície metálica											
Dimensão especificado incluindo mais de 75% de metal			Dimensões especificadas incluindo mais de 25% de vazio ⁽⁴⁾⁽⁵⁾											
Dimensão nominal (mm)	Todas as Dimensões exceto as especificadas na coluna 3	Espessura de parede de vazios fechados de mais de 70mm (excentricidade)(3)	Distância entre a dimensão especificada e a base mais próxima(mm)											
			5a15	15a30	30a60	60a100	100a150	150a200						
			Coluna1	Coluna2	Coluna3	Coluna4	Coluna5	Coluna6	Coluna7	Coluna8	Coluna9			
Até- 3,2	0,15	Mais ou menos	0,25	0,30	-	-	-	-	-	-	-	-	-	-
3,2-6,3	0,18	10% da	0,36	0,36	0,41	-	-	-	-	-	-	-	-	-
6,3-12,5	0,20	espessura	0,41	0,41	0,46	0,50	-	-	-	-	-	-	-	-
12,5-20	0,23	nominal	0,46	0,46	0,50	0,56	-	-	-	-	-	-	-	-
20-25	0,25		0,50	0,50	0,56	0,64	0,76	-	-	-	-	-	-	-
25-40	0,30	(0,25mm	0,58	0,58	0,66	0,76	0,88	-	-	-	-	-	-	-
40-50	0,36	mínimo)	0,66	0,66	0,78	0,92	1,05	1,25	-	-	-	-	-	-
50-100	0,60		0,96	0,96	1,20	1,45	1,70	2,05	-	-	-	-	-	-
100-150	0,86	(1,50mm	1,25	1,25	1,65	2,00	2,40	2,80	-	-	-	-	-	-
150-200	1,10	Máximo)	1,55	1,55	2,40	2,50	3,05	3,55	-	-	-	-	-	-
200-250	1,35		1,90	1,90	2,50	3,05	3,70	4,30	-	-	-	-	-	-

Retilinearidade

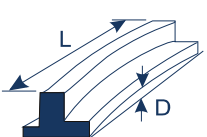

Diâmetro do menor círculo circunscrito (mm) (1)	Espessura mínima (mm)	Desvio(D) permissível por metro de comprimento (mm) (2)
Até 38,09	até 2,4	4,0
Até 38,10	Acima de 2,4	1,0
Acima de 38,10	Qualquer	1,0

Torção

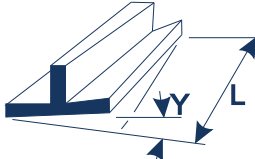



Diâmetro do menor círculo circunscrito (mm) (1)	Desvio(Y) permissível (graus)		
	Por metro de comprimento	No comprimento total	Torção Máxima
Até 38,09	3,3	3,3xL(metros)	7%
De 38,09 a 76,19	1,6	1,6xL(metros)	5%
Acima de 76,20	0,8	0,8xL(metros)	3%



extrutech alumínio

ESPECIFICAÇÕES TÉCNICAS

Diâmetros de Tubos Redondos

Diâmetro nominal da (mm)	 Desvio permitido do diâmetro médio AA+BB/2 em relação a espessura nominal	 Desvio permitido do diâmetro em qualquer ponto em relação ao diâmetro nominal (+_mm)(1)
	6,35 a 25,39 25,40 a 50,79 50,80 a 101,59 101,60 a 152,39 152,40 a 203,19 203,20 a 253,99	0,25 0,30 0,38 0,64 0,89 1,14

Comprimento

Diâmetro Externo ou largura nominal (mm) (1)	Desvio permitido em relação ao comprimento nominal (somente a mais) (mm)		
	Comprimento Nominal(mm)		
	Até 3.660	3.661 a 9.150	9.151 a 15.25
Até 76,193 De 76,20 a 203,204 Acima de 203,206	3,2 4,8 6,4	6,4 7,9 9,5	9,5 11,1 12,7

Angularidade

Espessura mínima da aba (mm) (3)	Desvio permitido em relação ao ângulo nominal (graus) (4)
Até 4,75 de 4,76 a 19,04 acima de 19,05	+_-2,0 +_-1,5 +_-1,0

Desvio permitido do quadro +/- 1°.

(1) Para vergalhões diâmetro nominal, para barras largura nominal.

(2) Para se obter o desvio permitido em barras de mais de 1 metro de comprimento, multiplica-se o valor d o comprimento pelo valor do desvio por metro.

(3) Quando houver duas abas adjacentes, considera-se a de menor espessura.

(4) Quando o espaço limitado pelo ângulo é todo metal, considera-se a menor espessura de metal no vértice do ângulo.



extrutech alumínio

Índice de perfis

Standart.....	10
Box Vidro 8mm.....	20
Vidro Temperado 8mm.....	23
Box Vidro 10mm.....	26
Vidro Temperado 10mm.....	27
Porta Deslizante.....	31
Kit Pia.....	32
Contra Marco.....	33
Padronizados - Porta de Giro.....	36
Padronizados -Janela de Correr.....	39
Padronizados - Venezianas.....	40
Venezianas.....	42
Linha 25.....	46
Linha 28.....	54
Linha 30.....	56
Linha Supremme.....	59
Linha Integrada.....	82
Linha Gold.....	91
Fachada.....	106
Lambris.....	115
Portões.....	123
Gradil.....	129
Guarda Corpo.....	130
Corrimão.....	134
Telas.....	135
Persianas.....	136
Agrícola.....	144
Policarbonato e Cobertura.....	147
Móveis ,Piscina e Jardins.....	149
Escadas.....	153
Componentes para Esquadrias.....	155
Automação Industrial.....	158
Implementos Rodoviários.....	160
Perfis Diversos.....	173

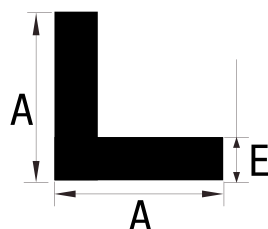

Cantoneiras de Abas Iguais

CÓDIGO	POLEGADAS		MILÍMETROS		PESO
	A	E	A	E	
ECT-003	1/2	-	12,70	1,00	0,066
ECT-007	1/2	1/16	12,70	1,58	0,102
ECT-008	5/8	1/16	15,88	1,58	0,129
ECT-004	3/4	-	19,05	1,00	0,100
ECT-005	3/4	-	19,05	1,58	0,156
ECT-006	3/4	1/16	19,05	3,18	0,300
ECT-010	7/8	1/8	22,22	3,18	0,354
ECT-011	5/8	1/8	15,88	1,00	0,083
ECT-012	1	-	25,40	1,00	0,134
ECT-013	1	-	25,40	1,20	0,161
ECT-002	1	1/16	25,40	1,58	0,210
ECT-018	1	1/8	25,40	3,18	0,409
ECT-016	1 1/4	1/16	31,75	1,58	0,264
ECT-019	1 1/4	1/8	31,75	3,18	0,518
ECT-001	1 1/2	1/16	38,10	1,58	0,318
ECT-023	1 1/2	1/8	38,10	3,18	0,627
ECT-024	1 1/2	3/16	38,10	4,76	0,918
ECT-025	2	1/16	50,80	1,58	0,427
ECT-028	2	-	50,80	2,00	0,538
ECT-026	2	1/8	50,80	3,18	0,845
ECT-027	2	3/16	50,80	4,76	1,245
ECT-030	2	3/8	50,80	9,52	2,367



Cantoneiras de Abas Desiguais

CÓDIGO	POLEGADAS			MILÍMETROS			PESO
	A	B	E	A	B	E	
ECT-200	-	-	-	22,50	12,50	2,20	0,195
ECT-201	2	1	1/8	50,80	25,40	3,18	0,627

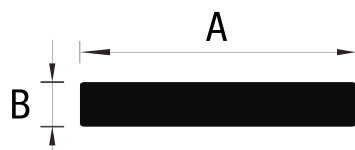

Barra Chata

CÓDIGO	POLEGADAS		MILÍMETROS		PESO
	A	B	A	B	
EBC-001	3/8	1/8	9,52	3,18	0,082
EBC-002	1/2	1/8	12,70	3,18	0,109
EBC-003	5/8	1/8	15,88	3,18	0,136
EBC-005	5/8	3/16	15,88	4,76	0,204
EBC-006	3/4	1/8	19,05	3,18	0,164
EBC-011	3/4	1/4	19,05	6,35	0,327
EBC-007	3/4	3/8	19,05	9,52	0,490
EBC-009	7/8	1/8	22,22	3,18	0,191
EBC-010	1	1/16	25,40	1,58	0,108
EBC-013	1	1/8	25,40	3,18	0,218
EBC-014	1	1/4	25,40	6,35	0,435
EBC-016	1	3/8	25,40	9,52	0,653
EBC-043	1	1/2	25,40	12,70	0,871
EBC-017	1 1/4	1/8	31,75	3,18	0,273
EBC-030	1 1/4	3/16	31,75	4,76	0,408
EBC-019	1 1/4	1/4	31,75	6,35	0,544
EBC-040	1 1/4	3/8	31,75	9,52	0,816
EBC-020	1 1/2	1/8	38,10	3,18	0,327
EBC-021	1 1/2	3/16	38,10	4,76	0,490
EBC-022	1 1/2	1/4	38,10	6,35	0,653
EBC-042	1 1/2	1/4	38,10	6,35	0,653
EBC-029	1 1/2	3/4	38,10	19,05	1,960
EBC-023	1 1/2	1	38,10	25,40	2,613
EBC-038	-	-	42,00	4,50	0,510
EBC-024	2	1/8	50,80	3,18	0,436
EBC-025	2	3/16	50,80	4,76	0,653
EBC-026	2	1/4	50,80	6,35	0,871
EBC-027	2	3/8	50,80	9,52	1,306
EBC-028	2 1/2	1/8	63,50	3,18	0,545
EBC-032	3	1/8	76,20	3,18	0,654
EBC-037	3	1/2	76,20	12,70	2,613
EBC-031	3	3/4	76,20	19,05	3,919
EBC-035	-	-	82,00	1,30	0,288
EBC-036	4	1/8	101,60	3,18	0,872
EBC-300	6	5/16	152,40	7,93	3,263
EBC-034	6	1/2	152,40	12,70	5,226
EBC-302	8	1/2	203,20	12,70	6,968

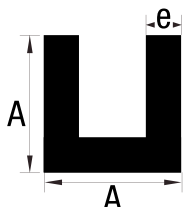

Perfil U de Abas Iguais

CÓDIGO	POLEGADAS		MILÍMETROS		PESO
	A	E	A	E	
EPU-003	-	3/76	12,50	1,00	0,096
EPU-004	1/2	1/16	12,70	1,58	0,149
EPU-002	5/8	3/76	15,88	1,00	0,123
EPU-104	3/4	1/16	19,05	1,58	0,230
EPU-106	1	1/16	25,40	1,58	0,312

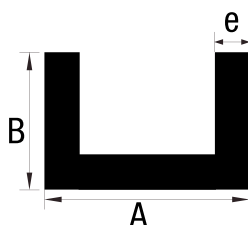

Perfil U de Abas Desiguais

CÓDIGO	POLEGADAS			MILÍMETROS			PESO
	A	B	E	A	B	E	
EPU-556	-	--		11,00	22,00	1,00	0,143
EPU-553	-	-	-	11,60	22,00	1,00	0,145
EPU-010	5/8	3/8	3/32	15,88	9,52	2,38	0,194
EPU-550	1	-	-	25,40	20,00	1,10	0,188
EPU-639	-	-	-	29,00	35	1,20	0,313
EPU-075	-	-	-	31,50	13,5	2,00	0,294
EPU-006	2	4	1/8	50,80	101,6	3,18	2,126

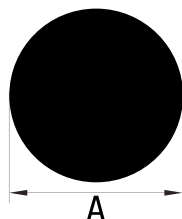

Vergalhão Redondo

CÓDIGO	POLEGADAS	MILÍMETROS	PESO
EVR-002	3/16	4,76	0,048
EVR-020	-	5,40	0,062
EVR-004	1/4	6,35	0,086
EVR-005	5/16	7,94	0,134
EVR-007	-	9,00	0,172
EVR-008	3/8	9,52	0,192
EVR-009	-	12,00	0,305
EVR-010	1/2	12,70	0,342
EVR-027	9/16	14,28	0,432
EVR-012	5/8	15,88	0,535
EVR-014	3/4	19,05	0,770
EVR-080	3/4	19,05	0,770
EVR-015	7/8	22,22	1,047
EVR-016	1	25,40	1,368
EVR-083	1	25,40	1,368
EVR-017	1 1/8	28,58	1,732
EVR-018	1 1/4	31,75	2,138
EVR-028	1 3/8	34,90	2,583
EVR-029	1 1/2	38,10	3,078
EVR-030	-	38,50	3,143
EVR-021	1 3/4	44,45	4,190
EVR-085	2	50,80	5,472
EVR-026	2 1/4	57,15	6,926
EVR-023	2 1/2	63,50	8,551
EVR-025	3	76,20	12,313

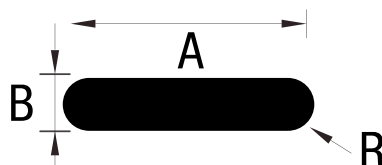

Barramentos Elétricos

CÓDIGO	POLEGADAS			MILÍMETROS			PESO
	A	B	R	A	B	R	
EBE-100	5/8	1/8	1/16	15,88	3,18	1,59	0,130
EBE-001	-	-	-	16,00	4,00	2,00	0,164
EBE-002	-	-	-	25,00	6,00	3,00	0,384
EBE-021	-	-	-	32,00	6,00	3,00	0,498
EBE-004	-	-	-	50,00	6,00	3,00	0,789
EBE-006	-	-	-	65,00	6,00	3,00	1,032
EBE-008	-	-	-	80,00	6,00	3,00	1,275
EBE-009	-	-	-	100,00	6,00	3,00	1,599
EBE-020	-	-	-	110,00	6,00	3,00	1,761
EBE-013	-	-	-	160,00	6,00	3,00	2,571
EBE-015	-	-	-	180,00	3,00	3,00	1,510
EBE-016	-	-	-	200,00	6,00	3,00	3,219
EBE-017	-	-	-	210,00	6,00	3,00	3,381
EBE-018	-	-	-	152,00	6,35	3,17	2,582
EBE-019	-	-	-	175,00	6,45	3,22	3,023

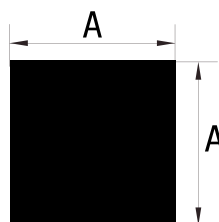

Vergalhão Quadrado

CÓDIGO	POLEGADAS	MILÍMETROS	PESO
EVQ-006	-	12,00	0,389
EVQ-012	1	25,40	1,742

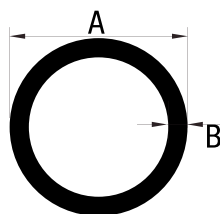

Tubos Redondos

CÓDIGO	POLEGADAS		MILÍMETROS		PESO
	A	E	A	E	
ETR-001	1/2	-	12,70	1,00	0,099
ETR-002	1/2	1/16	12,70	1,58	0,149
ETR-400	-	-	13,20	1,40	0,140
ETR-101	5/8	-	15,88	0,90	0,114
ETR-015	5/8	-	15,88	1,00	0,126
ETR-003	5/8	-	15,88	1,20	0,149
ETR-004	5/8	1/16	15,88	1,58	0,192
ETR-102	3/4	-	19,05	0,90	0,139
ETR-080	3/4	-	19,05	7,03	0,717
ETR-005	3/4	-	19,05	1,20	0,182
ETR-006	3/4	1/16	19,05	1,58	0,234
ETR-600	3/4	1/4	19,05	6,35	0,684
ETR-013	-	-	20,00	4,90	0,628
ETR-007	7/8	-	22,22	0,80	0,145
ETR-008	7/8	1/16	22,22	1,58	0,277
ETR-009	7/8	1/8	22,22	3,18	0,514
ETR-010	1	-	25,40	0,80	0,167
ETR-011	1	-	25,40	1,00	0,207
ETR-012	1	1/16	25,40	1,58	0,319
ETR-014	1	1/8	25,40	3,18	0,599
ETR-083	1	-	25,40	8,35	1,208
ETR-016	1 1/4	-	31,75	1,00	0,261
ETR-017	1 1/4	1/16	31,75	1,58	0,404
ETR-018	1 1/4	-	31,75	2,00	0,505
ETR-019	1 1/4	1/8	31,75	3,18	0,771
ETR-084	1 3/8	5/16	34,90	7,95	1,817
ETR-100	1 1/2	-	38,10	1,00	0,315
ETR-020	1 1/2	1/16	38,10	1,58	0,489
ETR-041	1 1/2	-	38,10	2,30	0,698
ETR-073	1 1/2	1/8	38,10	3,18	0,942
ETR-024	2	-	50,80	1,20	0,505
ETR-025	2	-	50,80	1,50	0,627
ETR-040	2	-	50,80	3,00	1,216
ETR-027	2	1/8	50,80	3,18	1,284
ETR-028	2	1/4	50,80	6,35	2,394
ETR-029	2	-	50,80	15,40	4,624
ETR-085	2	-	50,80	22,15	5,383
ETR-038	2 1/2	1/8	63,50	3,18	1,630
ETR-032	3	-	76,20	1,40	0,888
ETR-033	3	1/8	76,20	3,18	1,970
ETR-039	-	-	88,90	1,20	0,893
ETR-035	4	-	101,60	1,27	1,081
ETR-036	4	1/8	101,60	3,18	2,655
ETR-050	6	1/8	152,40	3,18	4,025

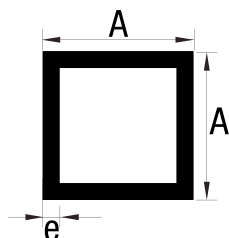

Tubo Quadrado

CÓDIGO	POLEGADAS		MILÍMETROS		PESO
	A	E	A	E	
ETQ-400	1/2	-	12,70	0,90	0,114
ETQ-001	1/2	1/16	12,70	1,58	0,200
ETQ-025	-	-	13,50	0,80	0,108
ETQ-002	-	-	14,00	0,80	0,112
ETQ-003	5/8	-	15,88	0,80	0,129
ETQ-004	5/8	1/16	15,88	1,58	0,254
ETQ-006	3/4	-	19,05	1,00	0,195
ETQ-007	3/4	1/16	19,05	1,58	0,308
ETQ-019	-	-	22,00	0,80	0,181
ETQ-005	-	-	24,00	0,80	0,199
ETQ-100	1	-	25,40	0,90	0,237
ETQ-011	1	-	25,40	1,00	0,264
ETQ-013	1	-	25,40	1,00	0,264
ETQ-010	1	1/16	25,40	1,58	0,416
ETQ-011	1	-	25,40	1,00	0,264
ETQ-013	1	-	25,40	1,20	0,316
ETQ-020	-	-	27,00	0,80	0,225
ETQ-012	1 1/2	1/16	38,10	1,58	0,633
ETQ-060	2	-	50,80	1,00	0,538
ETQ-015	2	-	50,80	1,10	0,592
ETQ-016	2	-	50,80	1,20	0,645
ETQ-021	2	-	50,80	1,50	0,807
ETQ-017	2	1/16	50,80	1,58	0,850
ETQ-018	2	-	50,80	2,00	1,076
ETQ-037	3	-	76,20	1,20	0,975
ETQ-036	3	1/16	76,20	1,58	1,283

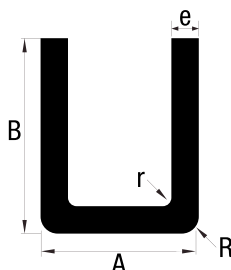

Perfil U de Abas Desiguais com Raio

CÓDIGO	POLEGADAS				MILÍMETROS				PESO
	A	B	E	R	A	B	E	R	
EPU-122	-	1	-	-	9,00	25,4	1,5	1	0,230
EPU-202	-	-	-	-	14,00	25	2	2	0,324

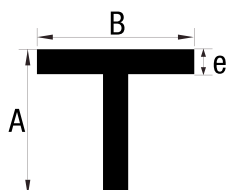

Perfis T

CÓDIGO	POLEGADAS			MILÍMETROS			PESO
	A	B	E	A	B	E	
ET-122	1 1/4	1 1/4	1/16	31,75	31,75	1,58	0,264
ET-002	1 1/2	1 1/2	1/8	38,10	38,10	3,18	0,627
ET-051	-	-	-	60,00	80,00	1,20	0,450
ET-052	4	2	1/4	101,60	50,8	6,35	2,504

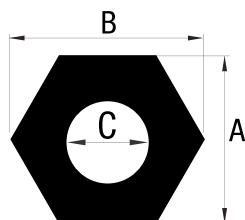

Tubo Sextavado

CÓDIGO	POLEGADAS			MILÍMETROS			PESO
	A	B	C	A	B	C	
EVS-027	-	-	-	26,98	31,06	14	1,291
EVS-026	-	-	-	31,75	36,47	19	1,597
EVS-028	-	-	-	34,92	40,10	19	2,093
EVS-022	-	-	-	35,00	40,33	15	2,395

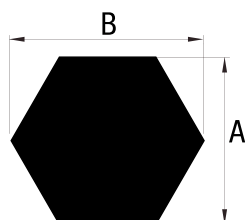

Vergalhão Sextavado

CÓDIGO	POLEGADAS		MILÍMETROS		PESO
	A	B	A	B	
EVS-023	--		6,35	7,25	0,378
EVS-010	-	-	12,80	11,10	0,289
EVS-011	-	1	29,30	25,40	1,514
EVS-012	-	1.1/8	33,00	28,58	1,916
EVS-021	-	-	34,92	39,60	2,850
EVS-013	-	1.1/4	36,00	31,75	2,365

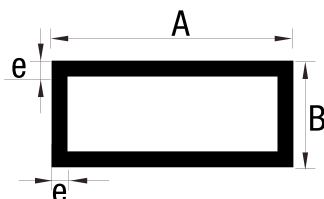

Tubo Retangular

CÓDIGO	POLEGADAS			MILÍMETROS			PESO
	A	B	E	A	B	E	
ETG-500	1	1/2	-	25,40	12,70	1,15	0,222
ETG-505	1	1/2	-	25,40	12,70	0,80	0,158
ETG-003	-	-	-	30,80	18,50	1,20	0,304
ETG-006	1 1/2	1	-	38,10	25,40	1,20	0,396
ETG-007	1 1/2	1	1/16	38,10	25,40	1,58	0,515
ETG-010	2	1/2	1/16	50,80	12,70	1,58	0,515
ETG-011	2	1	-	50,80	25,40	0,90	0,362
ETG-012	2	1	-	50,80	25,40	1,00	0,401
ETG-013	2	1	-	50,80	25,40	1,20	0,478
ETG-014	2	1	-	50,80	25,40	2,00	0,780
ETG-008	2	1 1/2	-	50,80	38,10	2,00	0,917
ETG-260	2 3/8	1 1/2	-	60,30	38,10	1,20	0,622
ETG-019	-	1 1/2	1/8	72,20	38,10	3,18	1,785
ETG-027	3	1 1/2	-	76,20	38,10	1,20	0,725
ETG-028	3	1 1/2	-	76,20	38,10	1,80	1,076
ETG-020	-	-	-	80,00	42,00	5,00	3,024
ETG-026	4	2	-	101,60	50,80	1,20	0,975
ETG-024	4	2	-	101,60	50,80	1,40	1,131
ETG-023	4	2	1/16	101,60	50,80	1,58	1,273
ETG-022	4	2	-	101,60	50,80	1,80	1,446
ETG-025	4	2	1/8	101,60	50,80	3,18	2,508
ETG-029	6	2	1/8	152,40	50,80	3,18	3,380

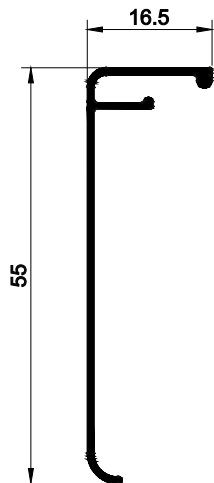

EBX-108
0,206 kg/m

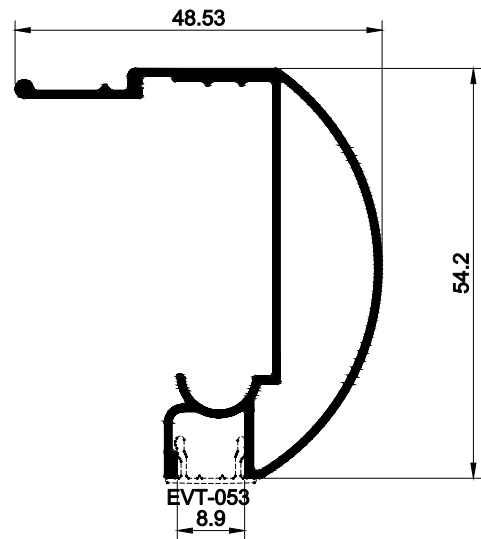

EBX-107
0,545 kg/m

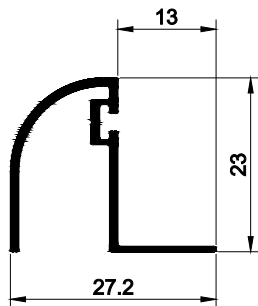

EBX-01 1
0,198 kg/m

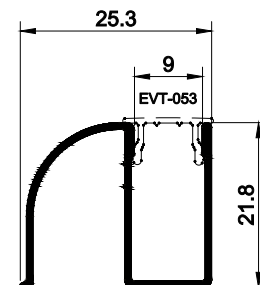

EBX-109
0,210 kg/m

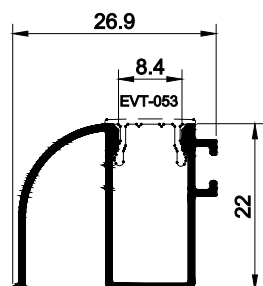

EBX-1 10
0,234 kg/m

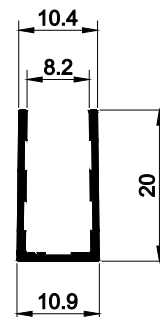

EPU-550
0,129 kg/m

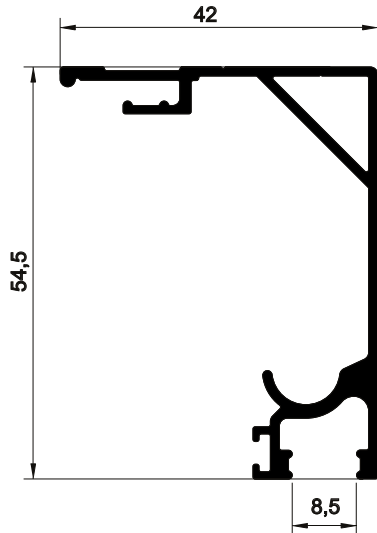

EBX-041
0,618 kg/m

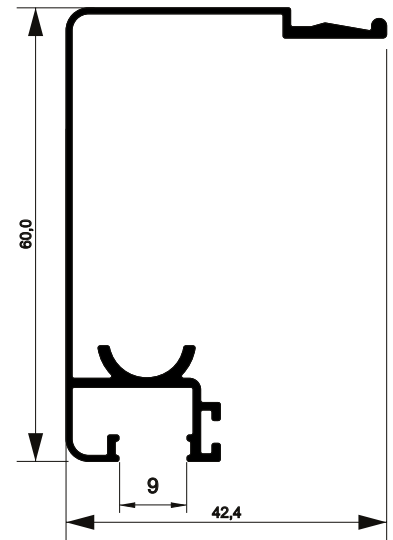

EBX-042
0,428 kg/m

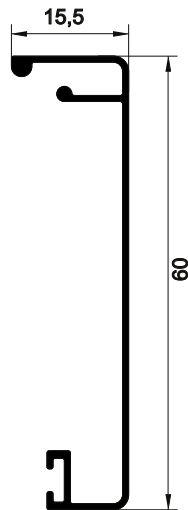

EBX-043
0,244 kg/m

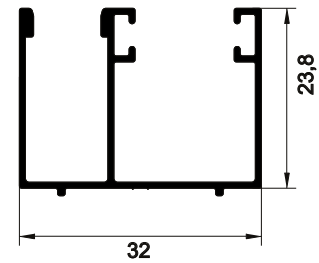

EBX-044
0,279 kg/m

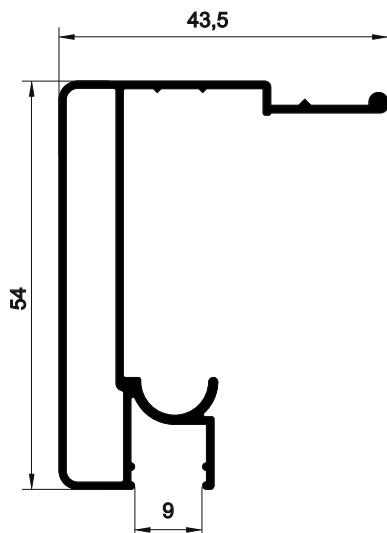

EBX-045
0,523 kg/m

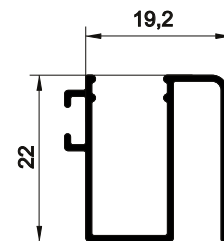

EBX-046
0,200 kg/m

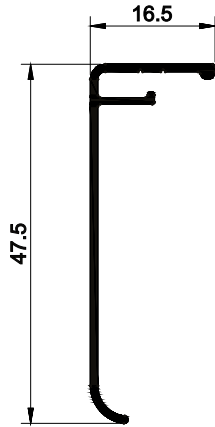

EBX-051
0,206 kg/m

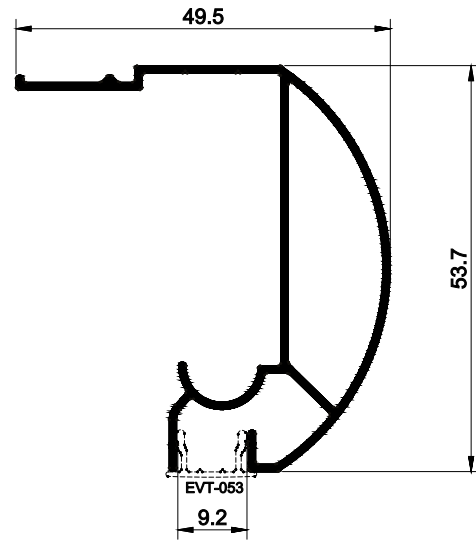

EBX-170
0,509 kg/m

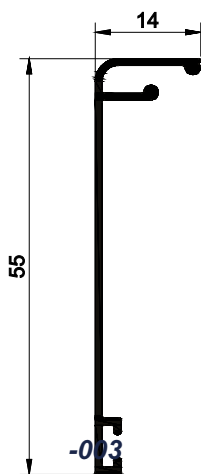

EVT-003
0,210 kg/m

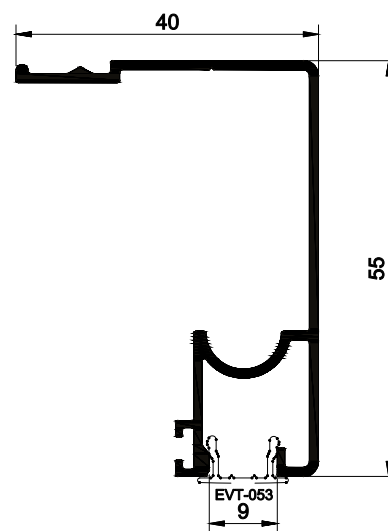

EVT-008
0,483 kg/m

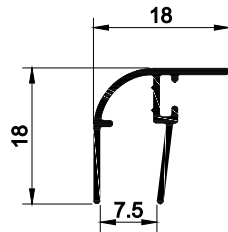

EVT-055
0,136 kg/m

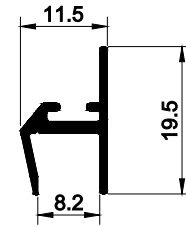

EVT-104
0,135 kg/m

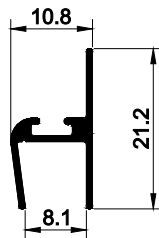

EVT-075
0,114 kg/m

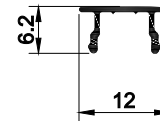

EVT-053
0,047 kg/m

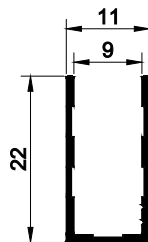

EPU-556
0,127 kg/m

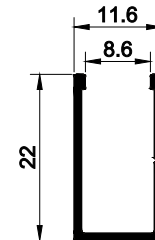

EPU-553
0,150 kg/m

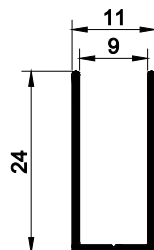

EPU-552
0,154 kg/m

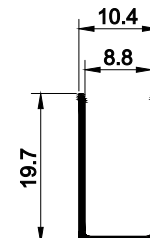

EPU-551
0,103 kg/m

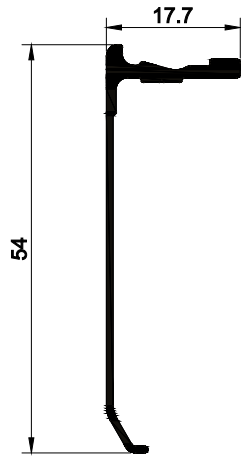

EVT-022
0,243 kg/m

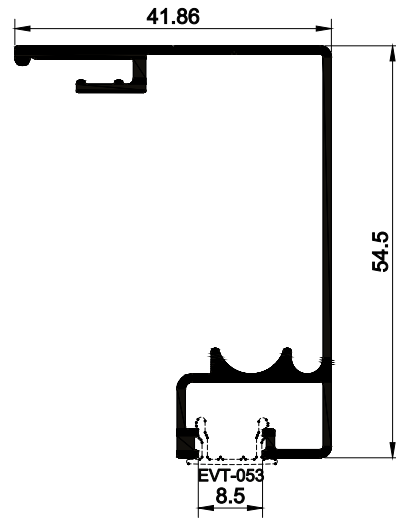

EVT-024
0,537 kg/m

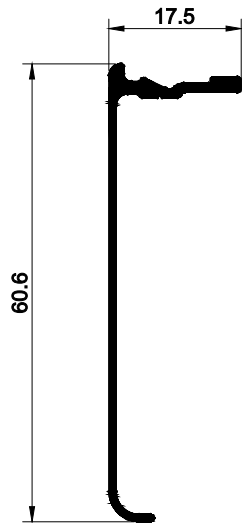

EVT-034
0,257 kg/m

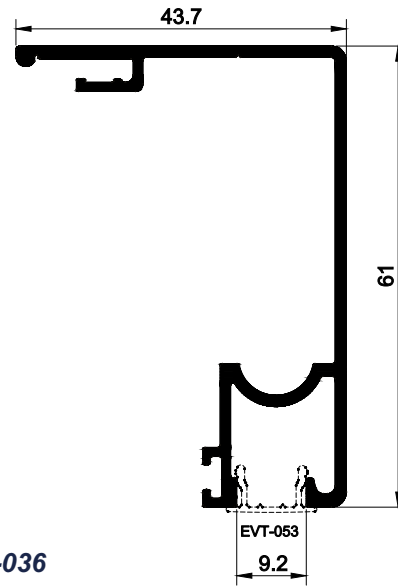

EVT-036
0,668 kg/m

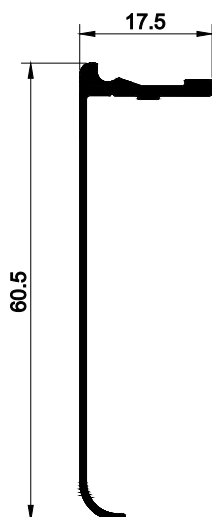

EVT-714
0,244 kg/m

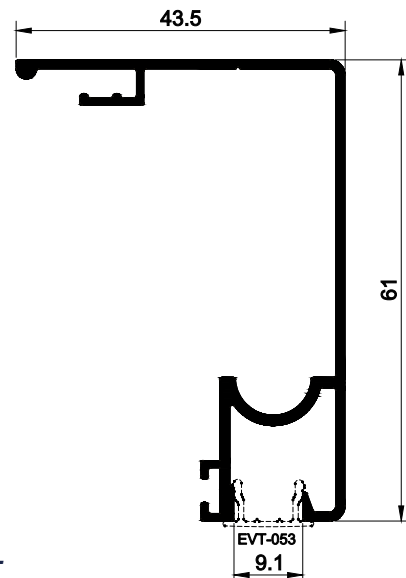

EVT-713L
0,576 kg/m

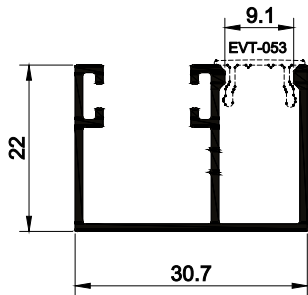

EBX-027
0,310 kg/m

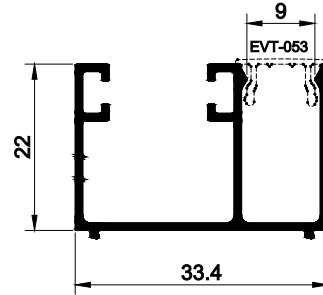

EVT-038
0,326 kg/m

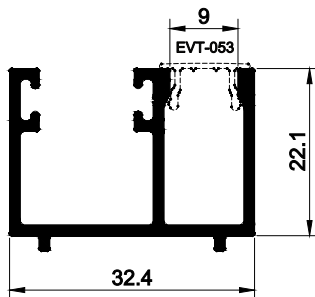

EVT-120
0,442 kg/m

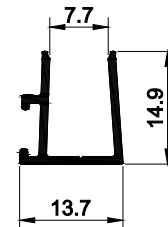

EVT-026
0,123 kg/m

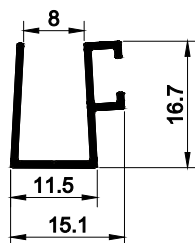

EVT-031
0,131 kg/m

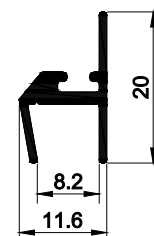

EVT-025
0,149 kg/m

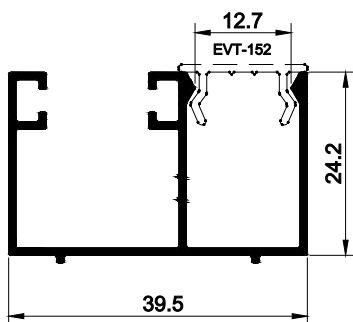

EVT-150
0,371 kg/m

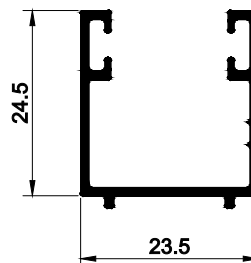

EBX-030
0,274 kg/m

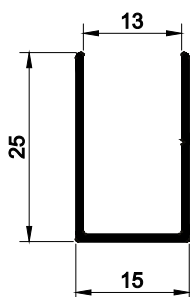

EPU-555
0,170 kg/m

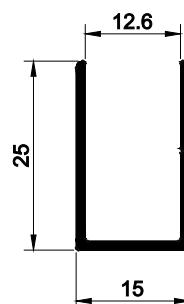

EPU-557
0,202 kg/m

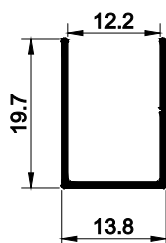

EPU-554
0,111 kg/m

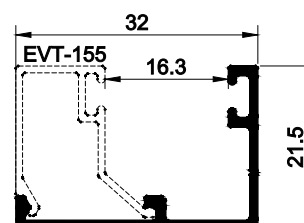

EVT-154
0,212 kg/m

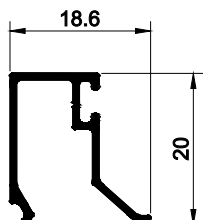

EVT-155
0,150 kg/m

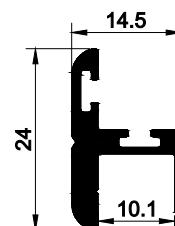

EVT-153
0,270 kg/m

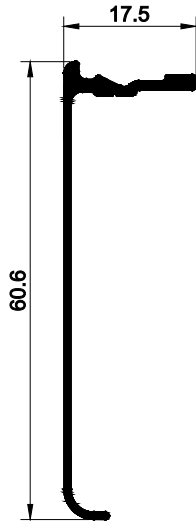

EBX-034
0,257 kg/m



EVT-009
0,263 kg/m

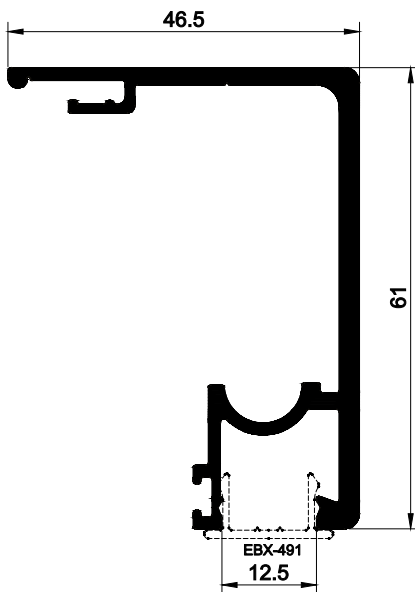

EVT-035
0,967 kg/m

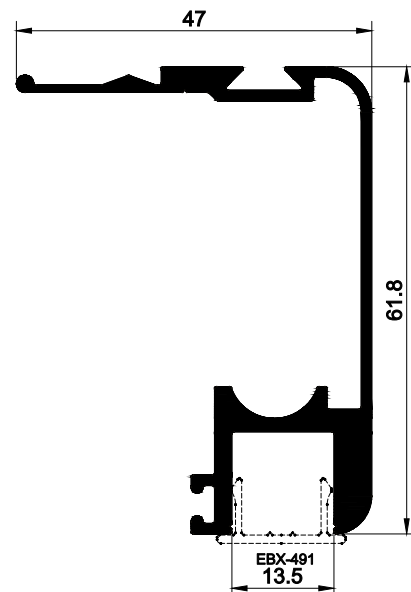

EVT-007
0,895 kg/m

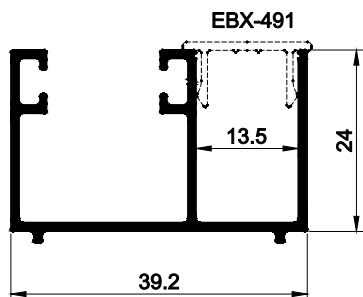

EVT-029
0,406 kg/m

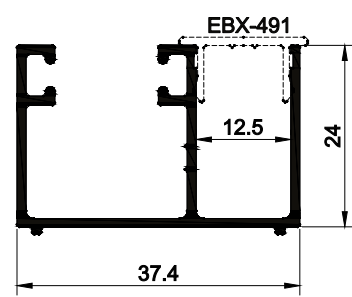

EVT-037
0,405 kg/m

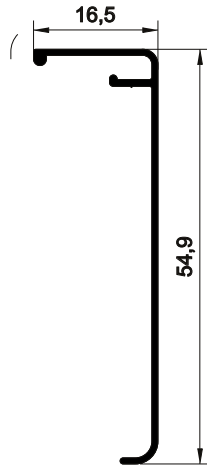

EVT-020
0,178 kg/m

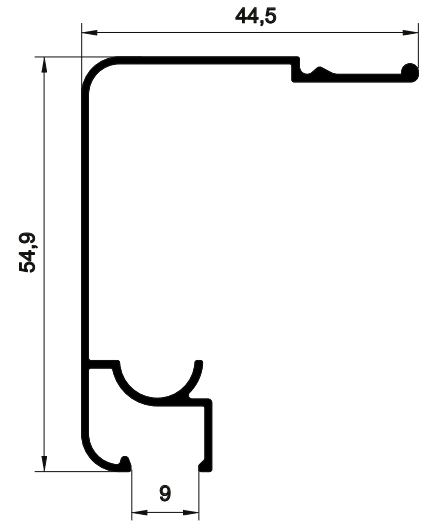

EVT-019
0,362 kg/m

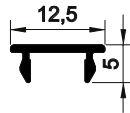

EVT-018
0,055 kg/m

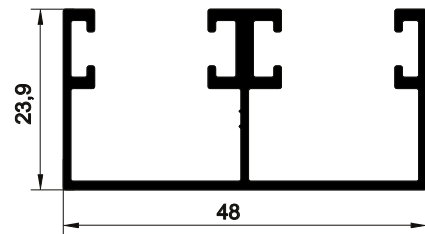

EVT-028
0,515 kg/m

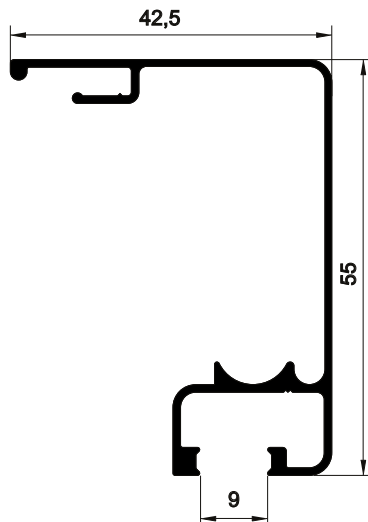

EVT-081
0,473 kg/m

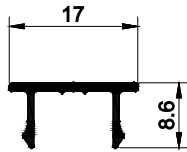

EVT-491
0,086 kg/m

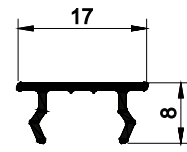

EVT-152
0,087 kg/m

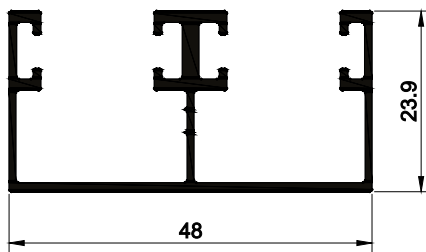

EVT-280
0,510 kg/m

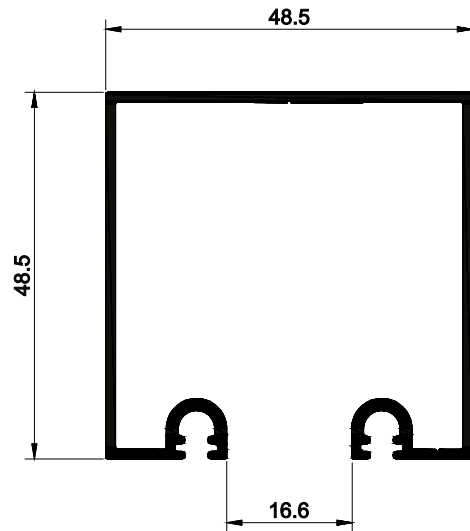

EVT-002
0,723 kg/m

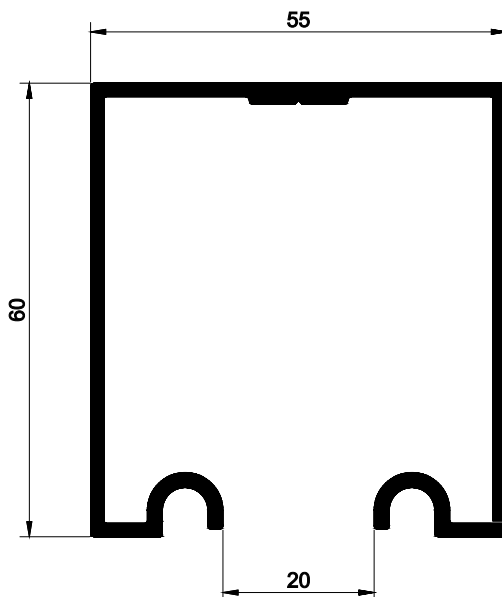

EVT-010
1,126 kg/m

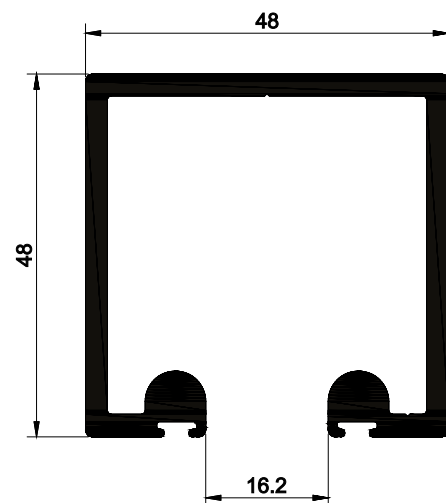

EVT-006
1,458 kg/m

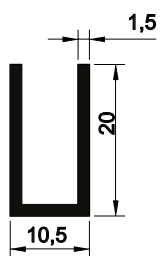

EPU-008
0,192 kg/m

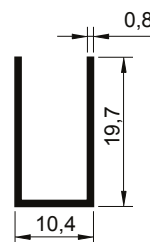

EPU-551
0,103 kg/m

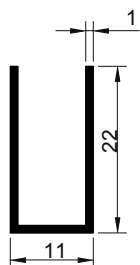

EPU-552
0,143 kg/m

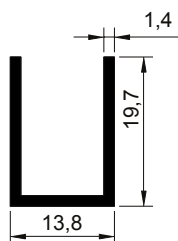

EPU-554
0,189 kg/m

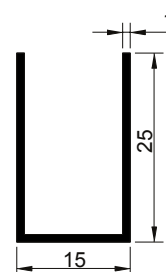

EPU-555
0,167 kg/m

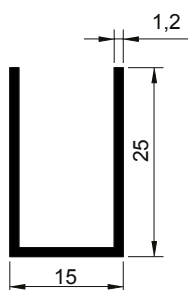

EPU-557
0,203 kg/m

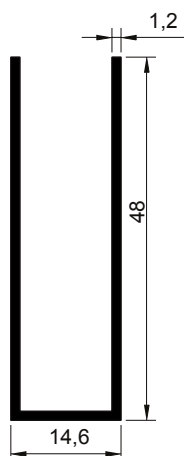

EPU-558
0,348 kg/m

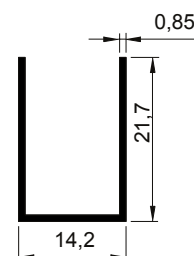

EPU-559
0,127 kg/m

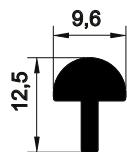

EPO-301
0,161 kg/m

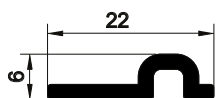

EPO-302
0,152 kg/m

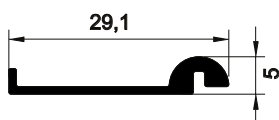

EPO-305
0,130 kg/m

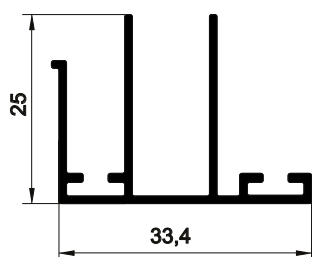

EPO-303
0,317 kg/m

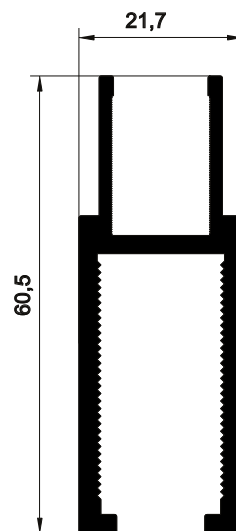

EPO-300
0,932 kg/m

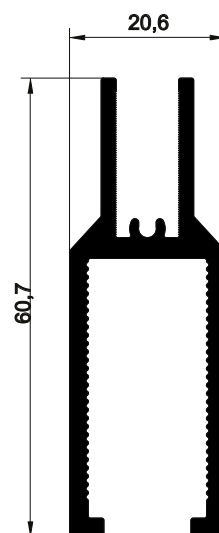

EPO-306
0,900 kg/m

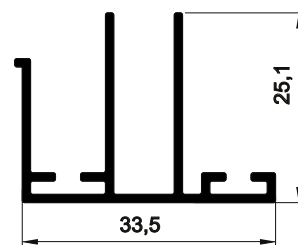

EPO-304
0,348 kg/m

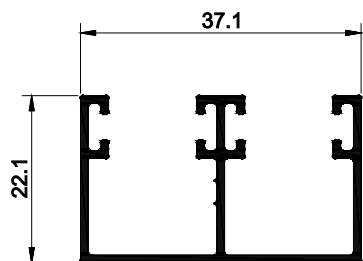

EVT-1493
0,360 kg/m

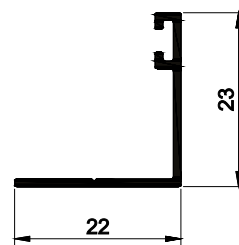

EVT-1494
0,138 kg/m

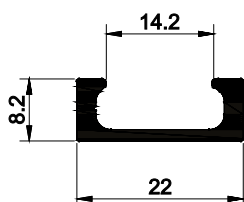

EVT-1492
0,196 kg/m

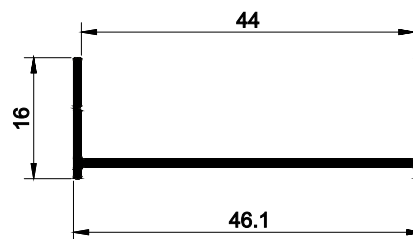

EPU-399
0,222 kg/m

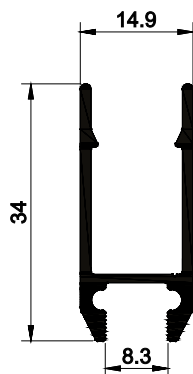

EVT-1491
0,303 kg/m

CONTRA MARCO

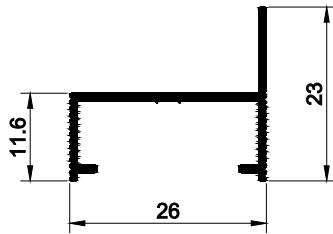

ECM-200
0,166 kg/m

CONTRA MARCO

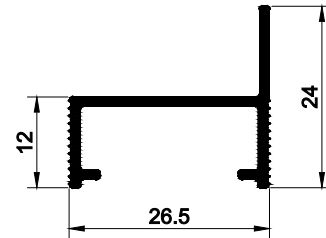

ECM-063
0,223 kg/m

CONTRA MARCO

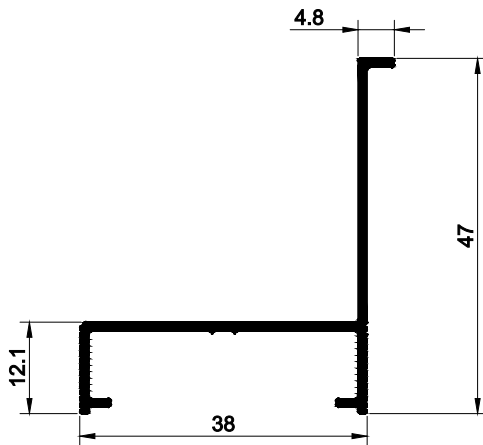

ECM-098
0,329 kg/m

CONTRA MARCO

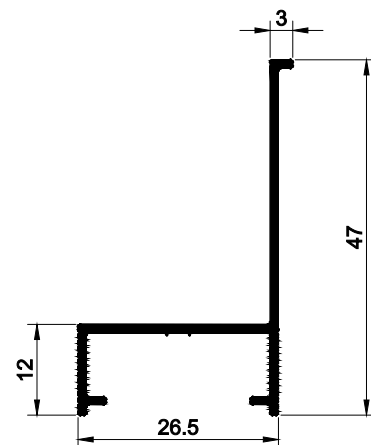

ECM-151
0,262 kg/m

CONTRA MARCO

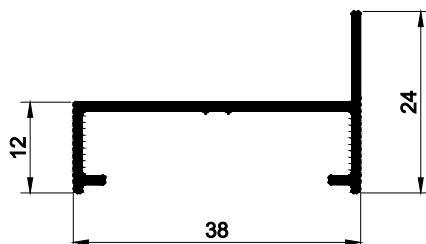

ECM-060
0,245 kg/m

CONTRA MARCO

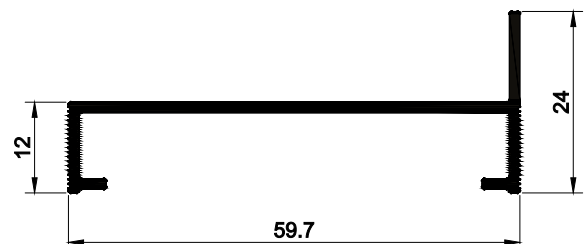

ECM-174
0,371 kg/m

MACHO

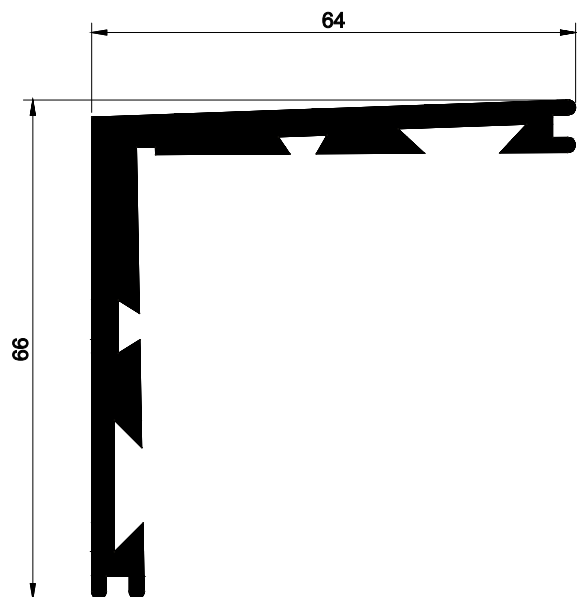

ECL-009
1,666 kg/m

CUNHA

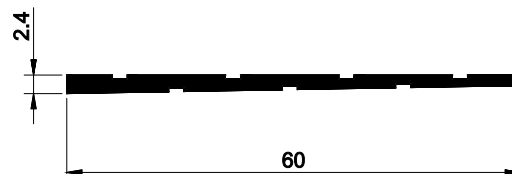

ECL-010
0,293 kg/m

MACHO

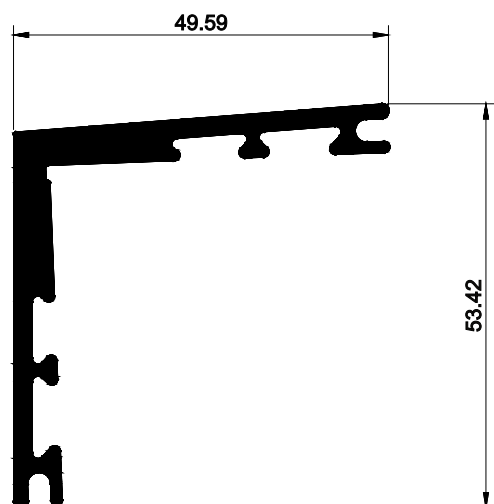

ECL-006
1,040 kg/m

CUNHA

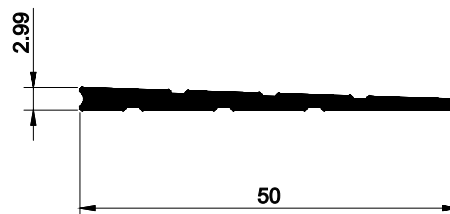

ECL-011
0,287 kg/m

ARREMATE

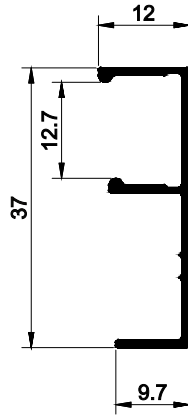

EMP-347
0,183 kg/m

ARREMATE

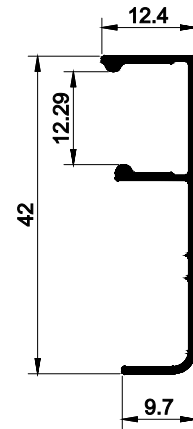

EMN-014
0,190 kg/m

ARREMATE PISO

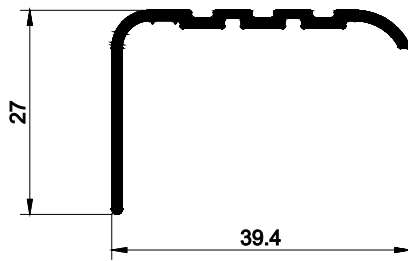

EME-013
0,261 kg/m

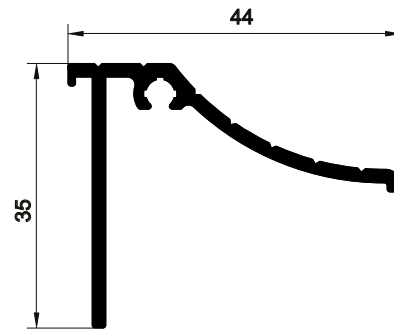

ECM-169
0,431 kg/m

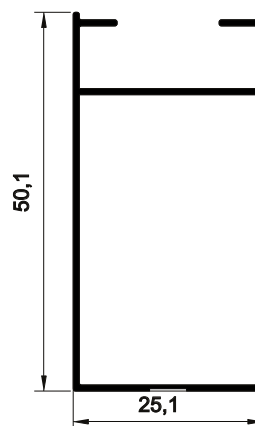
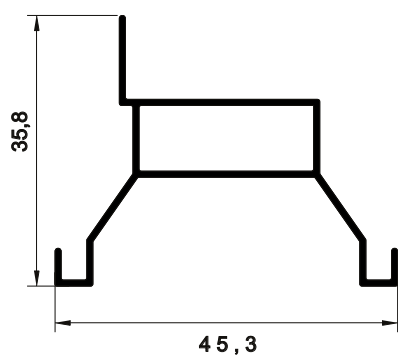

ECP-001
0,279 kg/m

ECP-002
0,340 kg/m

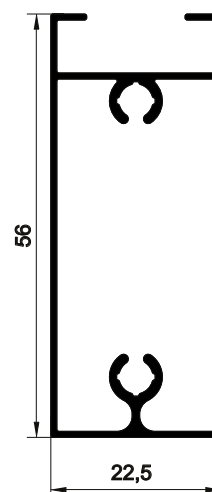
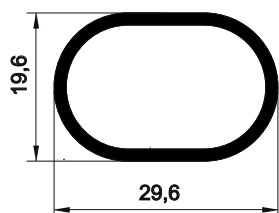

ECP-003
0,083 kg/m

ECP-004
0,463 kg/m

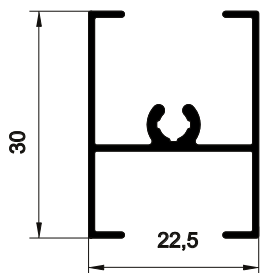

ECP-005
0,260 kg/m

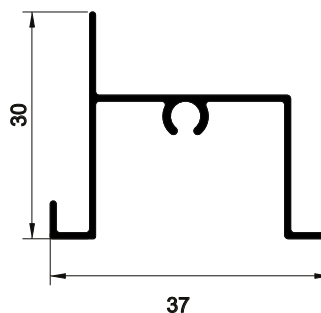

ECP-011
0,229 kg/m

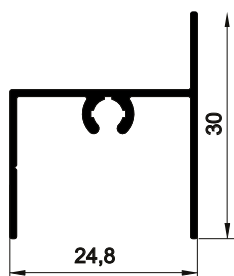

ECP-066
0,199 kg/m

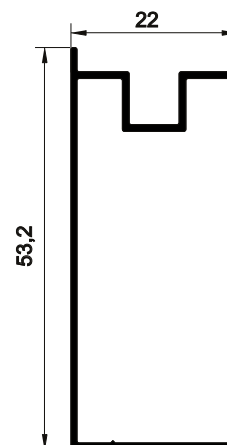

ECP-070
0,364 kg/m

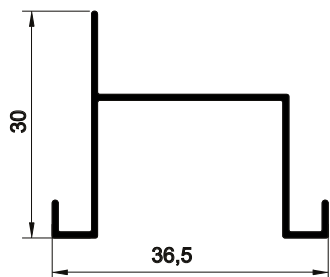

ECP-016
0,199 kg/m

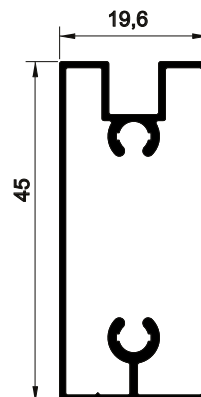

ECP-071
0,413 kg/m

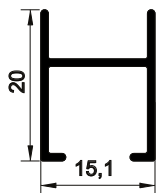

ECP-025
0,155 kg/m

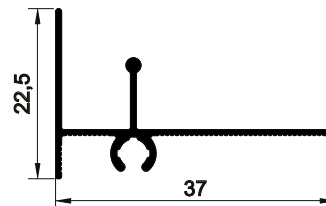

ECP-026
0,189 kg/m

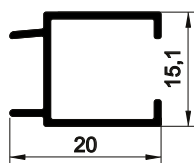

ECP-027
0,142 kg/m

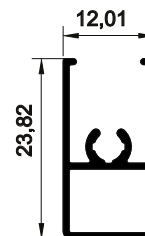

ECP-028
0,178 kg/m

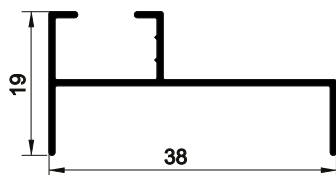

ECP-039
0,173 kg/m

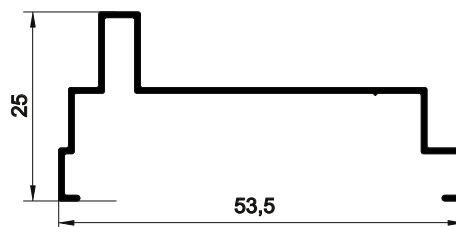

ECP-046
0,215 kg/m

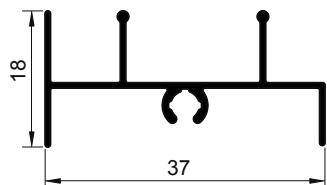

ECP-008
0,279 kg/m

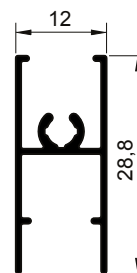

ECP-009
0,340 kg/m

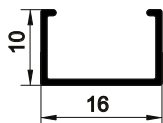

ECP-010
0,079 kg/m

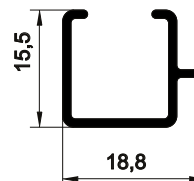

ECP-024
0,160 kg/m

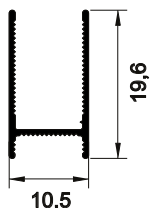

ECP-067
0,089 kg/m

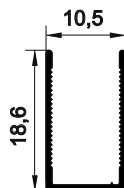

ECP-068
0,089 kg/m

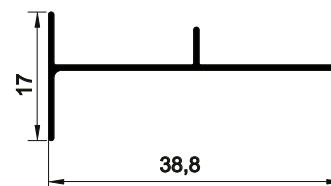

ECP-006
0,146 kg/m

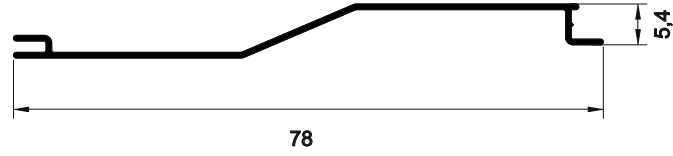

ECP-072
0,185 kg/m

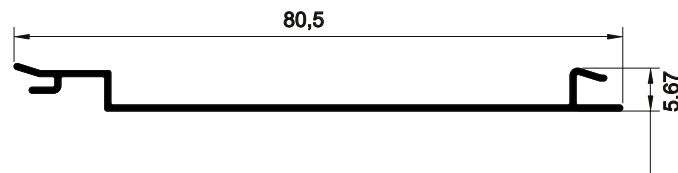

ECP-073
0,216 kg/m

VENEZIANA

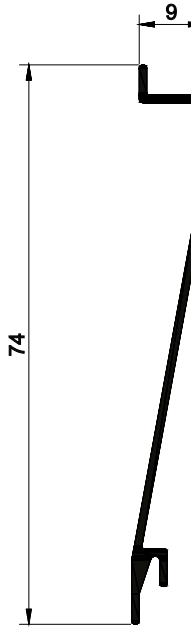

EVZ-024
0,254 kg/m

VENEZIANA

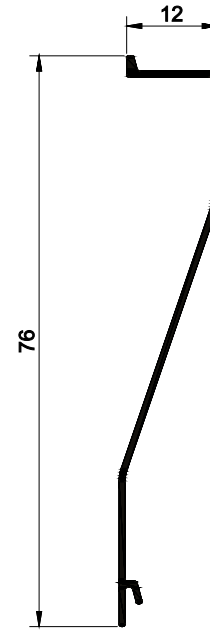

EVZ-169
0,203 kg/m

VENEZIANA

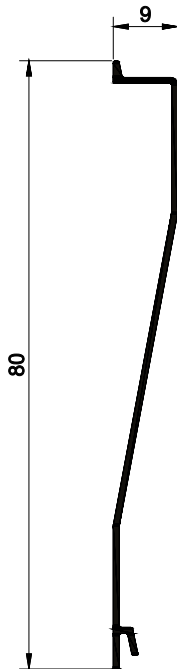

EVZ-0620
0,201 kg/m

VENEZIANA

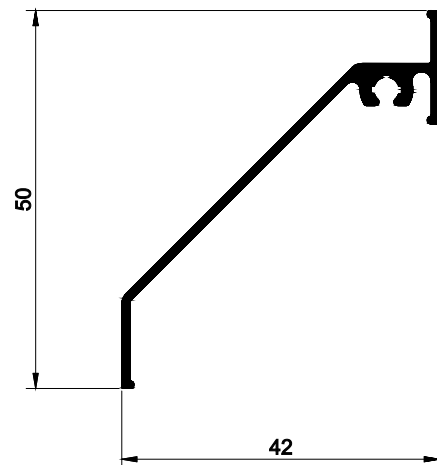

EVZ-047
0,298 kg/m

VENEZIANA

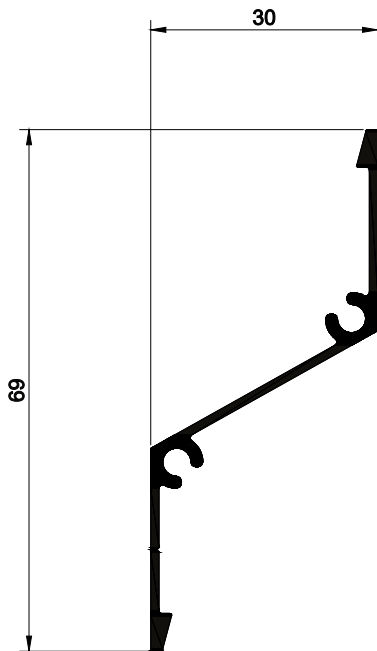

EVZ-060
0,357 kg/m

VENEZIANA

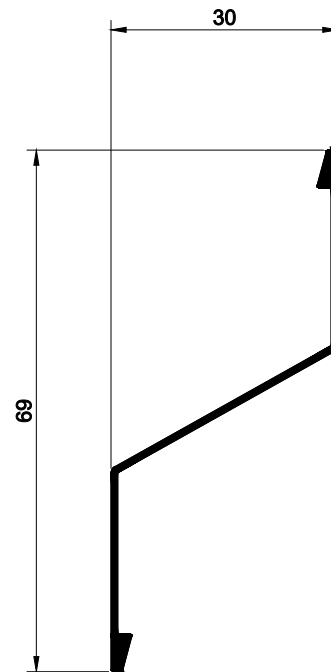

EVZ-060L
0,244 kg/m

VENEZIANA

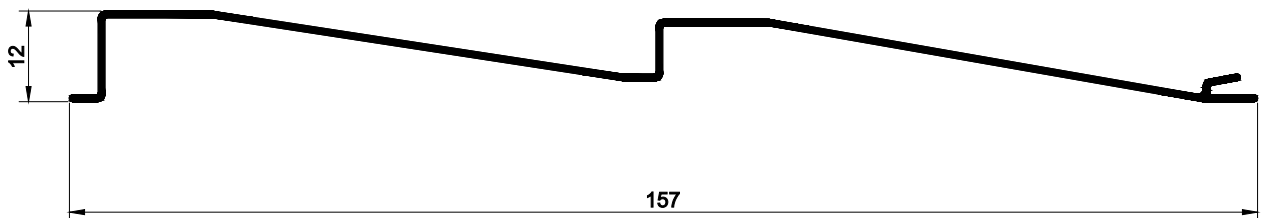

EVZ-075
0,440 kg/m

VENEZIANA

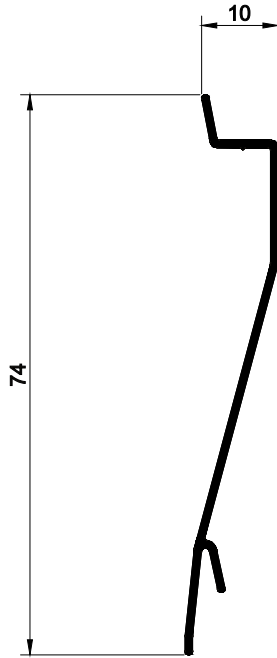

EVZ-051 (Z-284/E)
0,244 kg/m

VENEZIANA VENTILADA

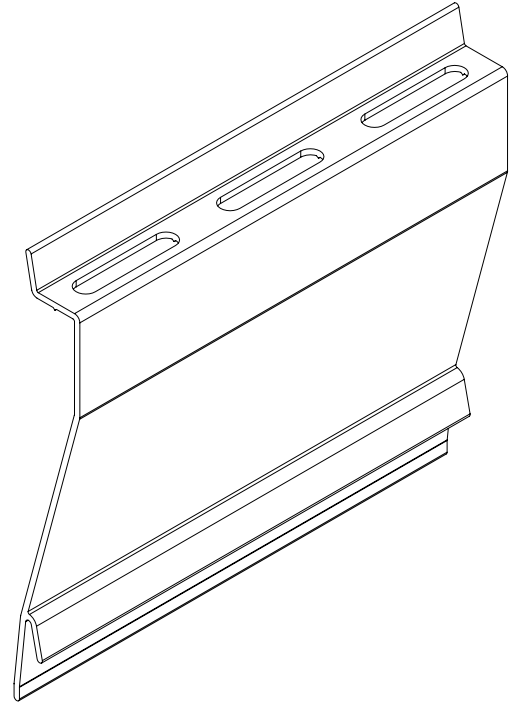

EUS-294
0,244 kg/m

VENEZIANA

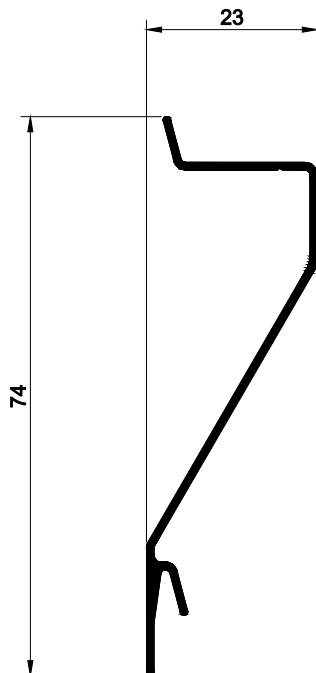

EVZ-203
0,295 kg/m

VENEZIANA VENTILADA

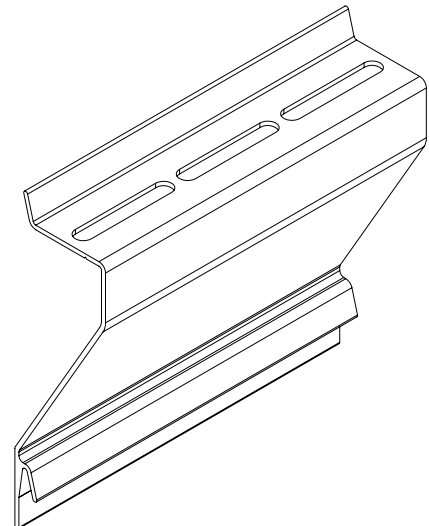

EUS-294
0,295 kg/m

VENEZIANA

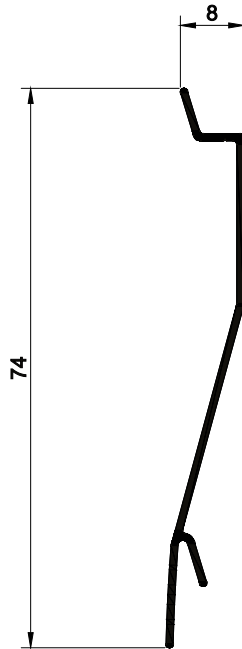

EVZ-201
0,227 kg/m

VENEZIANA VENTILADA

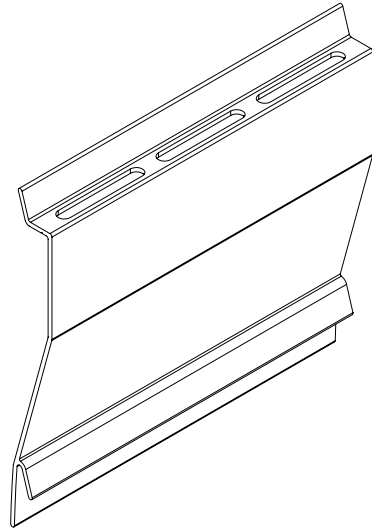

EUS-201
0,227 kg/m

VENEZIANA

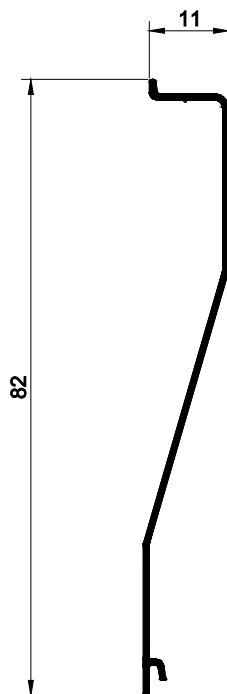

EVZ-221
0,209 kg/m

VENEZIANA

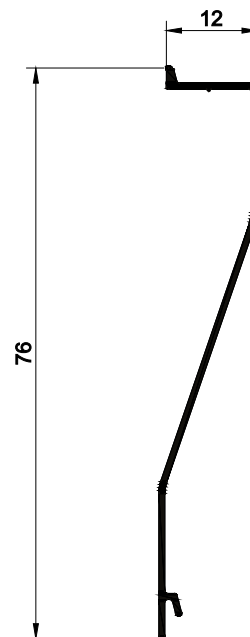

EVZ-169
0,203 kg/m

PERFIL MATA JUNTA

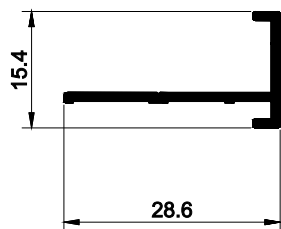

E25-100
0,156 kg/m

PERFIL MATA JUNTA / GIRO

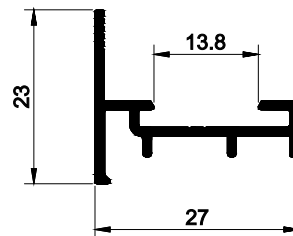

E25-099
0,229 kg/m

PERFIL TELA MOSQUITEIRA

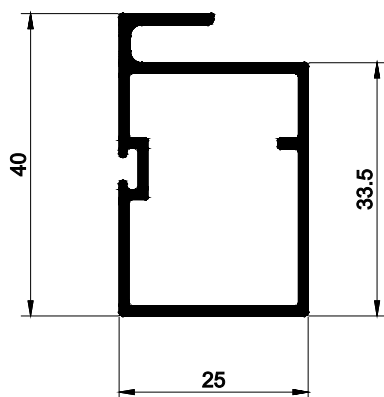

E25-549
0,507 kg/m

PERFIL MATA JUNTA

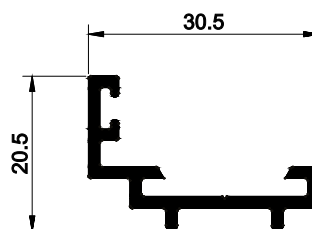

E25-548
0,281 kg/m

BAGUETE

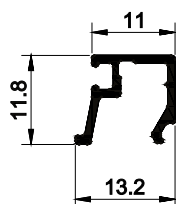

EBG-001
0,103 kg/m

PERFIL FOLHA / MAXIM-AR

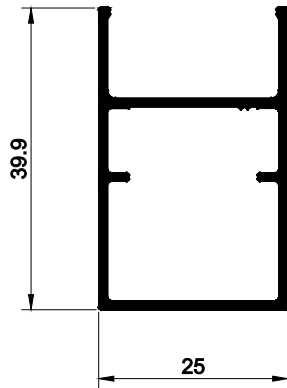
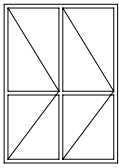

E25-312
0,431 kg/m

PERFIL FOLHA / GIRO

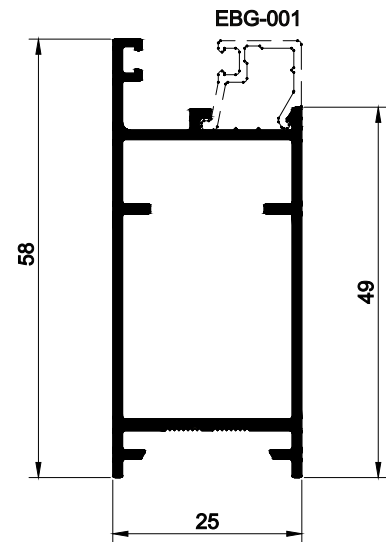
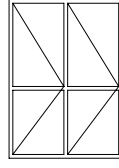

E25-023
0,629 Kg/m

PERFIL TRAVESSA FOLHA / GIRO

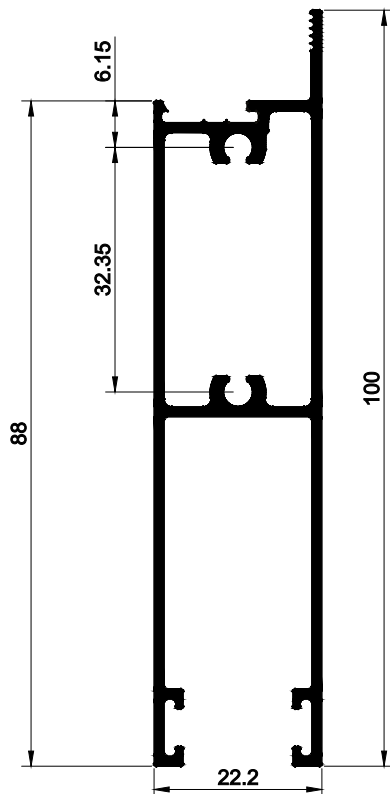
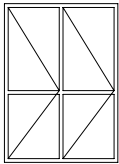

E25-101
0,992 kg/m

MARCO / GIRO

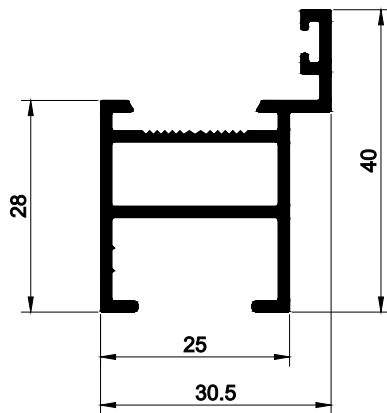
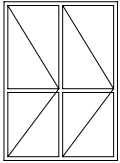

E25-024
0,542 kg/m

MARCO / GIRO

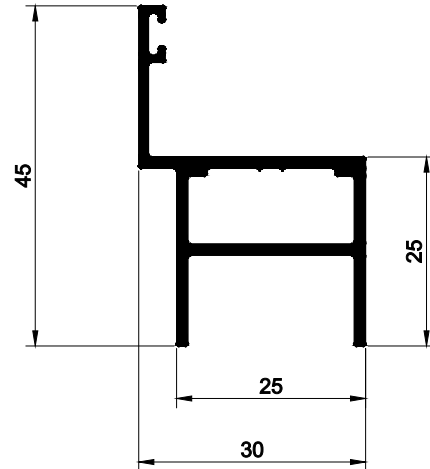
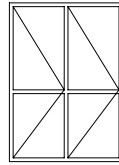

E25-522
0,504 Kg/m

PERFIL FOLHA / GIRO

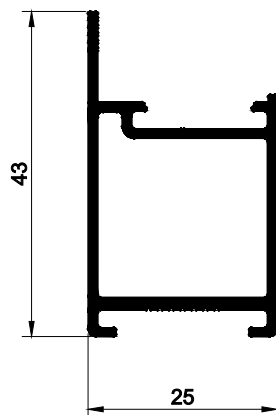
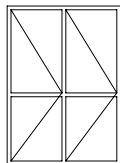

E25-120
0,482 kg/m

TRAVESSA / GIRO

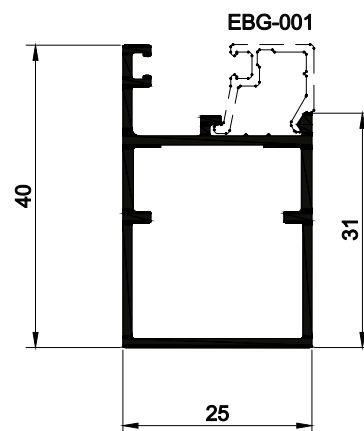
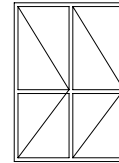

E25-011
0,448 Kg/m

MARCO / MAXIM-AR

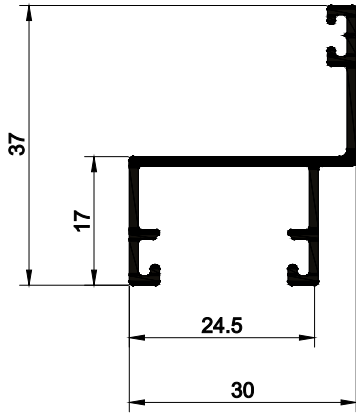

E25-002
0,333 kg/m

PERFIL FOLHA / MAXIM-AR

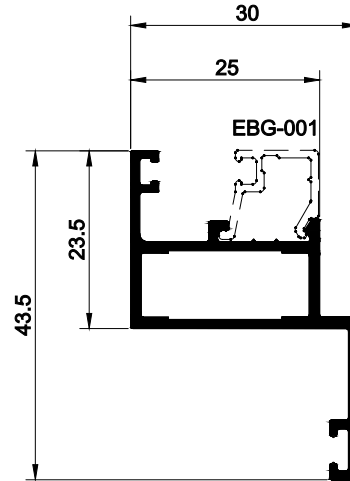

E25-005
0,431 Kg/m

PERFIL FOLHA / MAXIM-AR

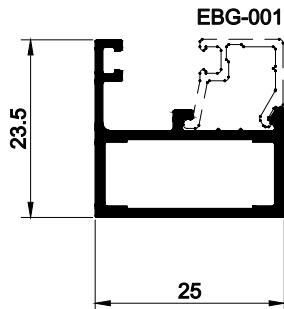

E25-004
0,312 kg/m

PERFIL FOLHA / MAXIM-AR

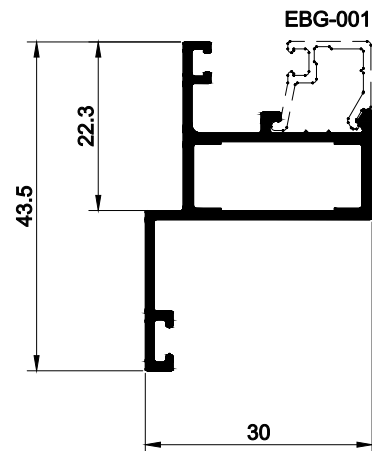

E25-006
0,431 Kg/m

COLUNA / MAXIM-AR

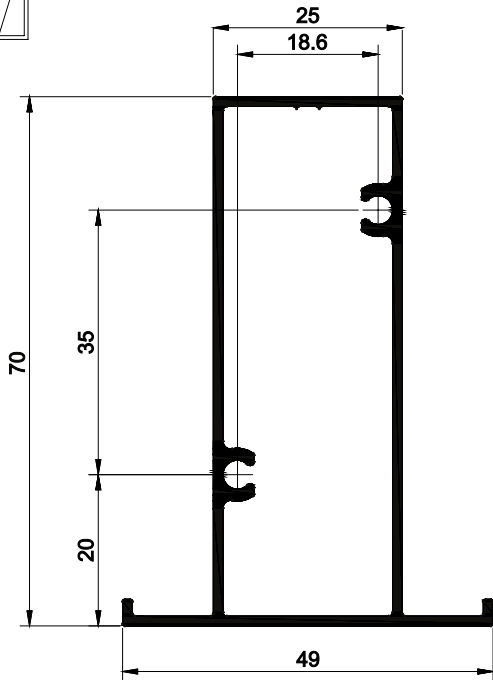
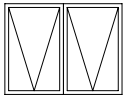

EFC-070
0,835 kg/m

PERFIL MÃO DE AMIGO / CORRER

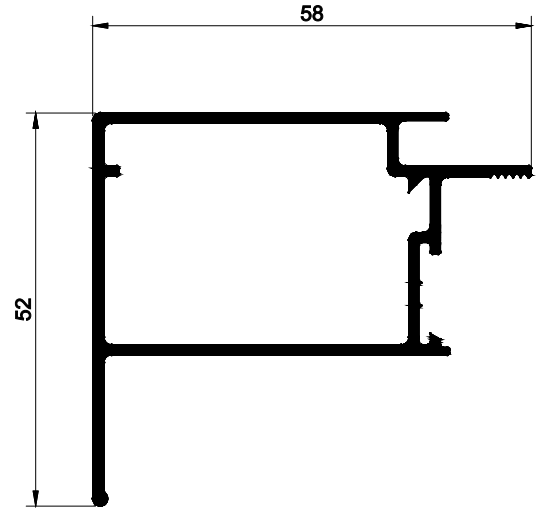
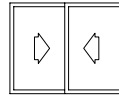

E25-036
0,749 Kg/m

TRAVESSA INFERIOR E SUPERIOR / CORRER

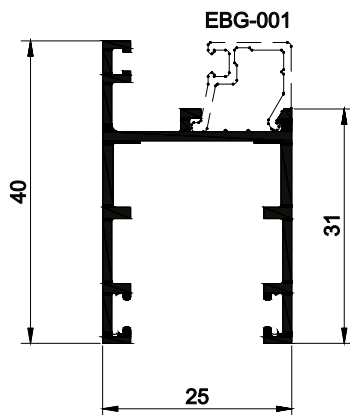
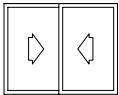

E25-014
0,417 kg/m

TRAVESSA INFERIOR E SUPERIOR / CORRER

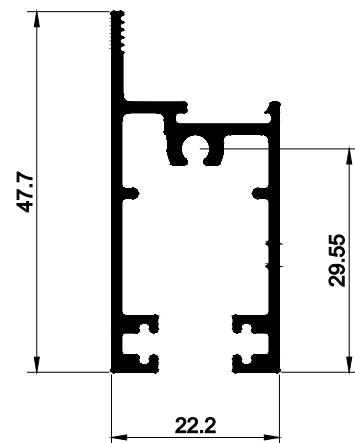
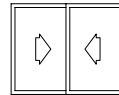

E25-102
0,550 Kg/m

TRAVESSA INFERIOR E SUPERIOR / CORRER

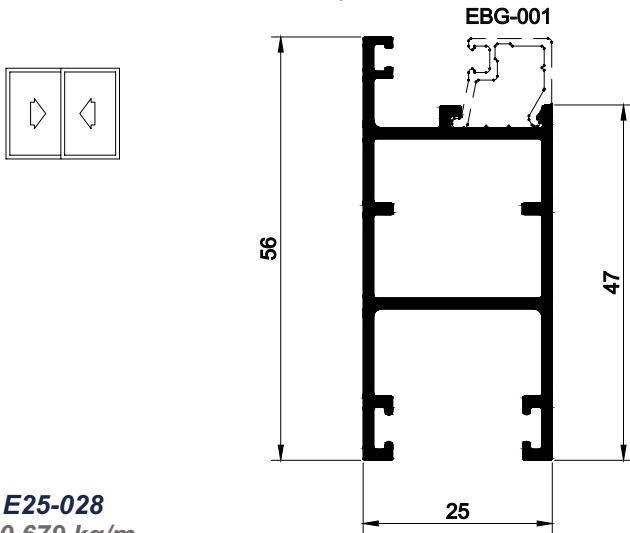

E25-028
0,679 kg/m

TRAVESSA INFERIOR E SUPERIOR / CORRER

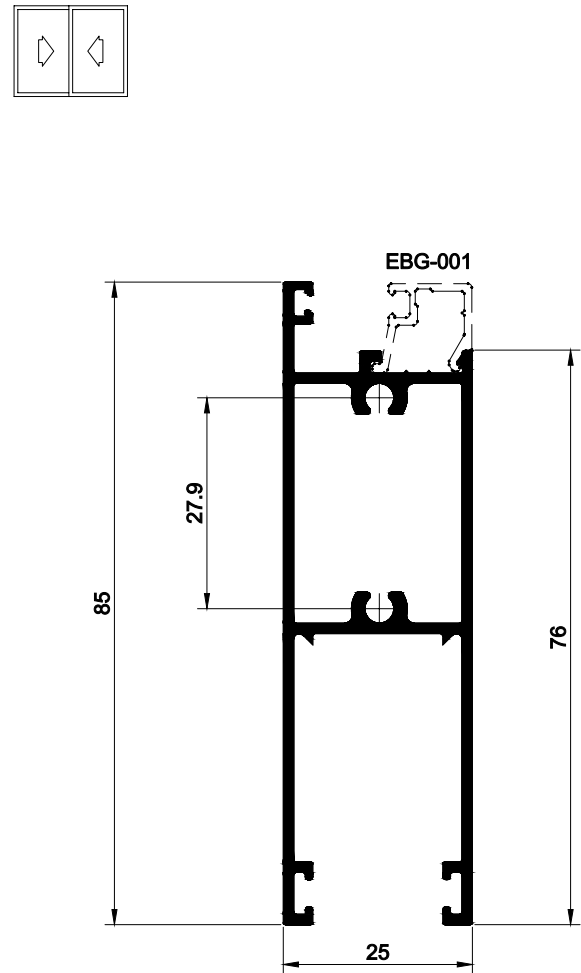

E25-029
0,959 kg/m

PERFIL FOLHA / MAXIM-AR

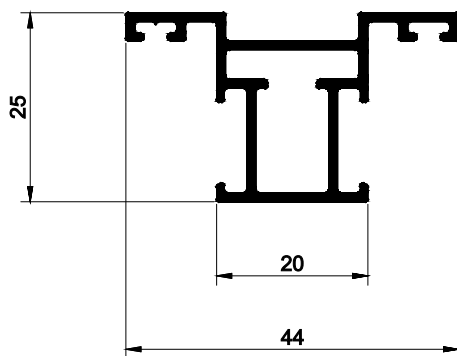

E25-308
0,454 kg/m

COLUNA / MAXIM-AR

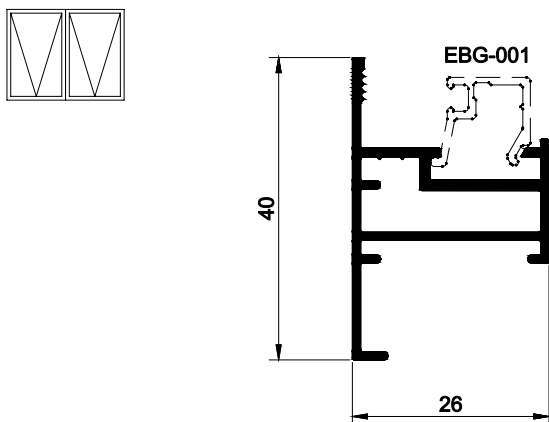

E25-052
0,390 kg/m

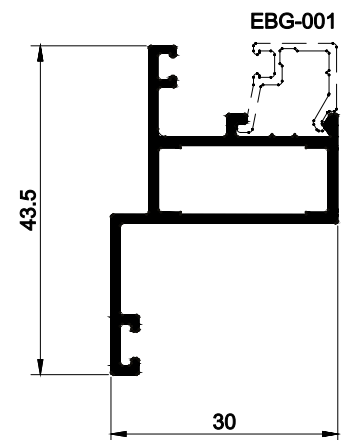

E25-205
0,421 kg/m

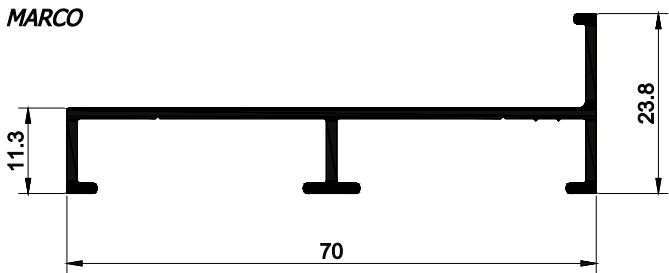
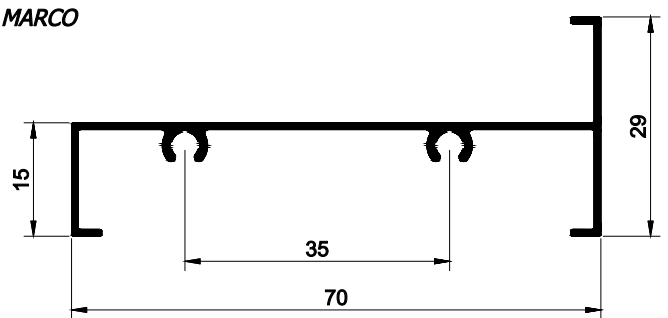
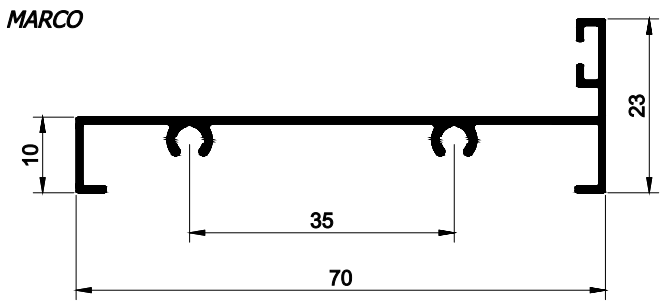
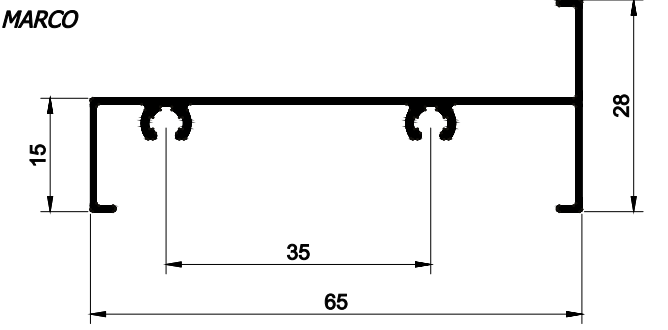
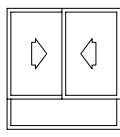
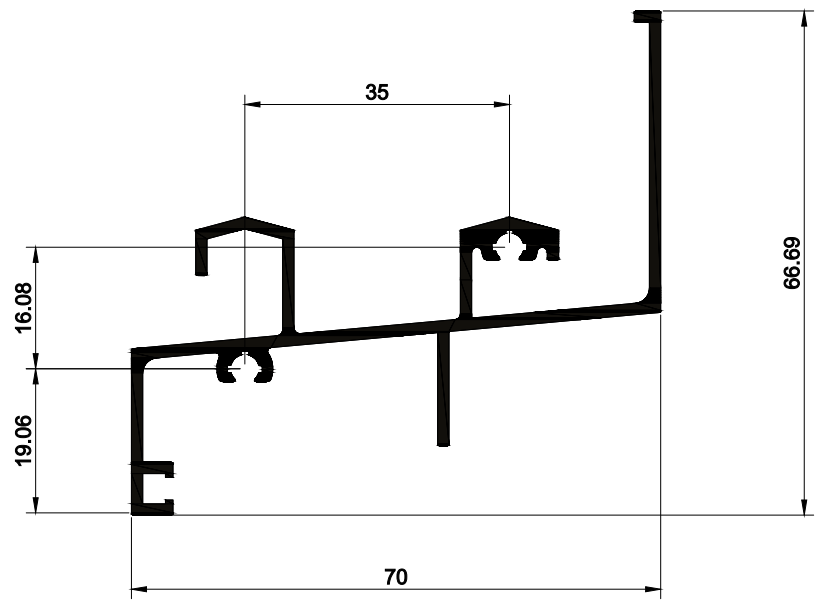
<p>MARCO</p>  <p>E25-165 0,473 kg/m</p>	<p>MARCO</p>  <p>E25-175 0,357 Kg/m</p>
<p>MARCO</p>  <p>E25-176 0,347 kg/m</p>	<p>MARCO</p>  <p>E25-177 0,322 Kg/m</p>
<p>TRILHO DOIS PLANOS COM PEITORIL / CORRER</p>   <p>E25-034 0,958 kg/m</p>	

PERFIL MÃO DE AMIGO / CORRER

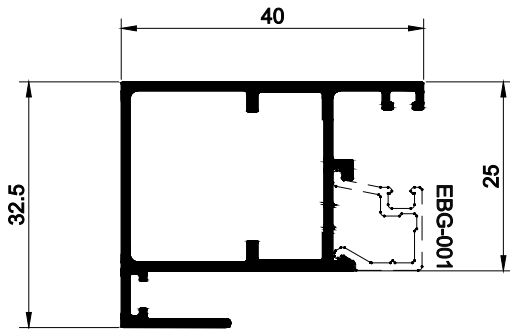
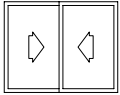

E25-012
0,526 kg/m

PERFIL MÃO DE AMIGO / CORRER

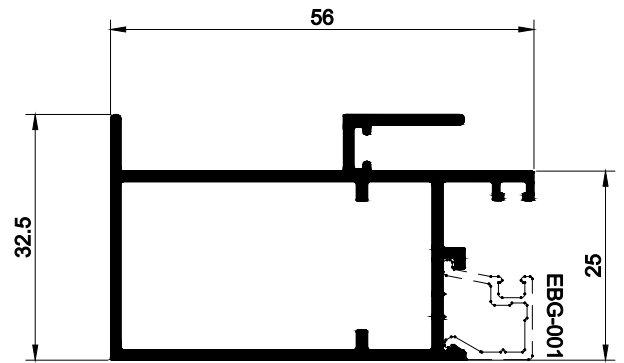
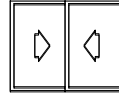

E25-506
0,740 Kg/m

PERFIL MÃO DE AMIGO / CORRER

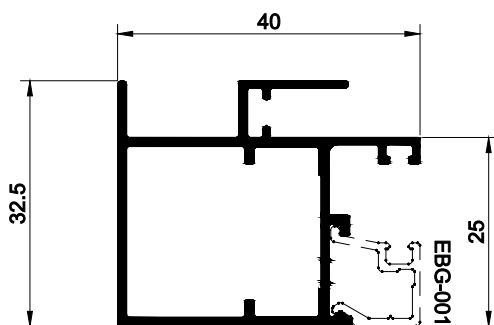
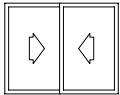

E25-215
0,518 kg/m

PERFIL MÃO DE AMIGO / CORRER

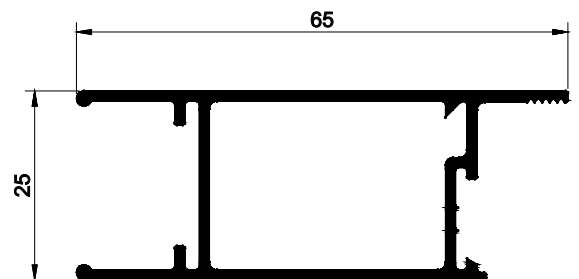
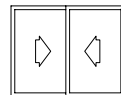

E25-033
0,655 Kg/m

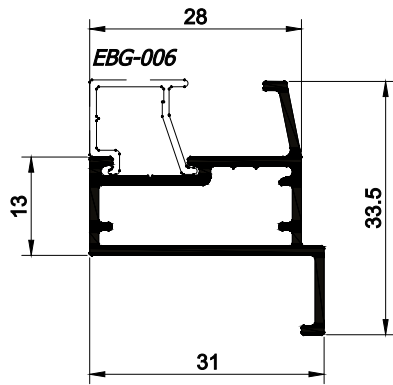

E28-003
0,375 kg/m

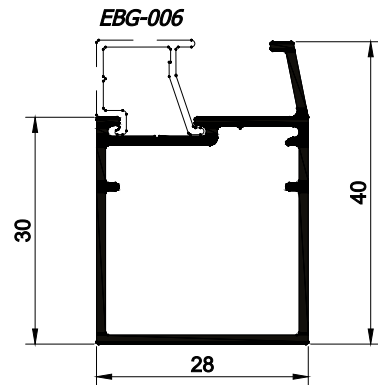

E28-005
0,436 kg/m

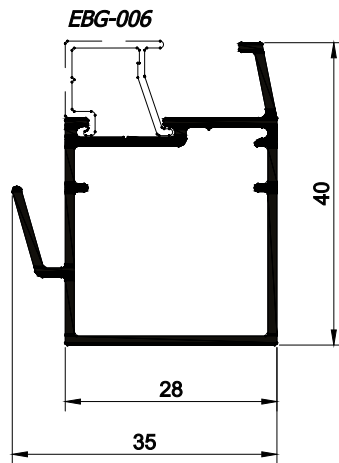

E28-007
0,485 kg/m

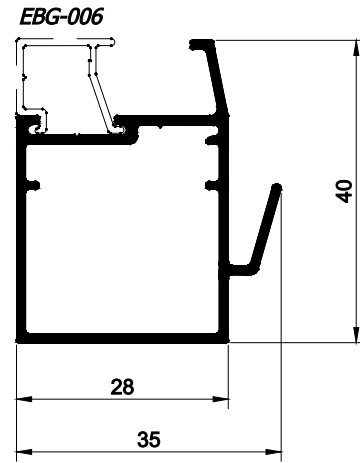

E28-008
0,485 kg/m

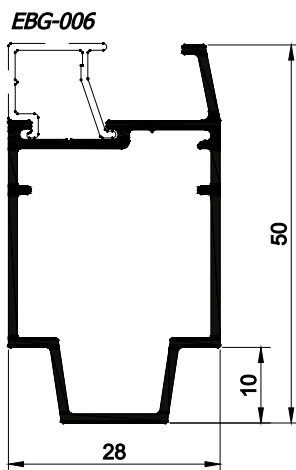

E28-009
0,493 kg/m

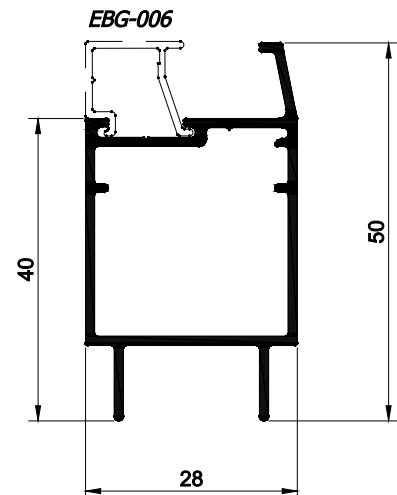

E28-010
0,501 kg/m

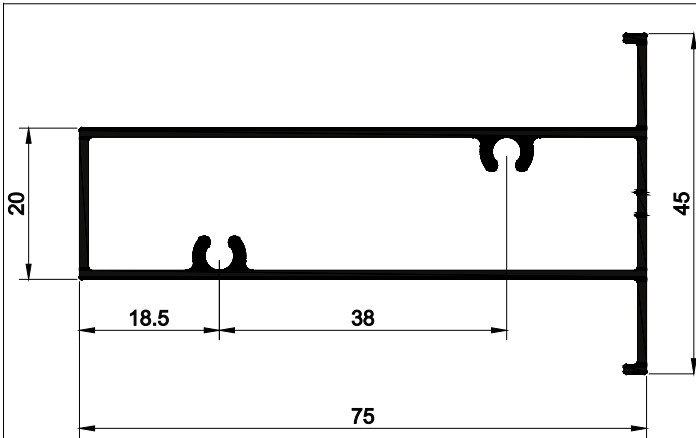

E28-016
0,783 kg/m

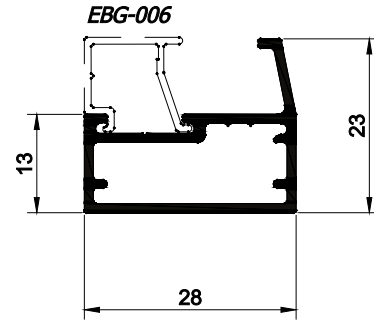

E28-017
0,325 kg/m

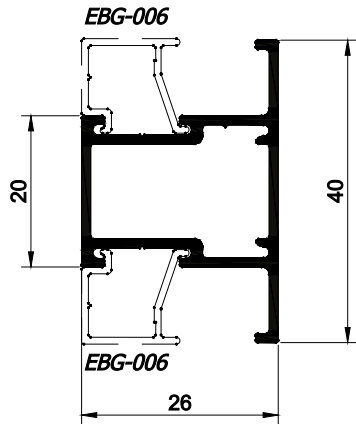

E28-028
0,412 kg/m

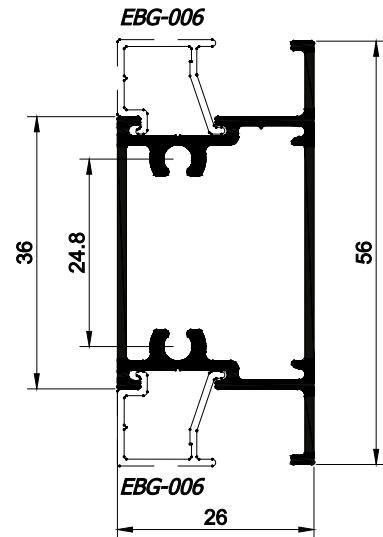

E28-589
0,607 kg/m

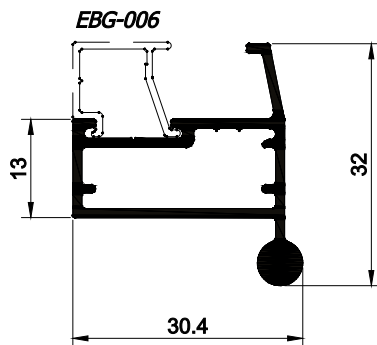

E28-048
0,415 kg/m

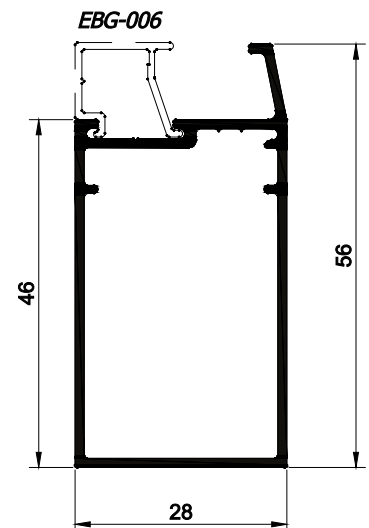

E28-012
0,542 kg/m

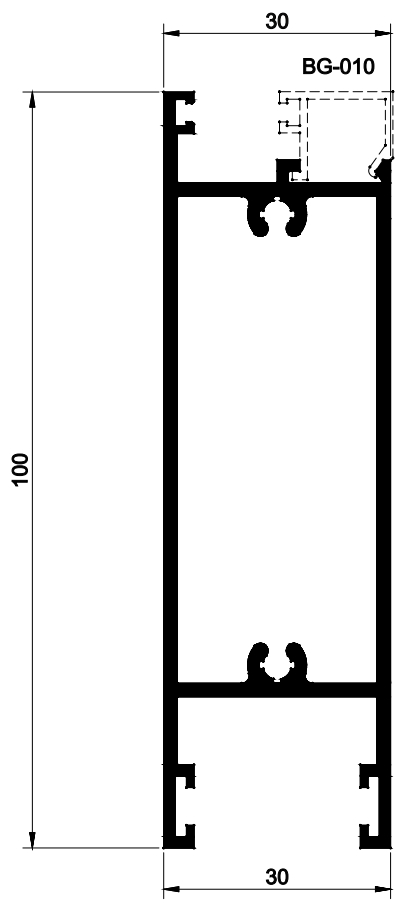
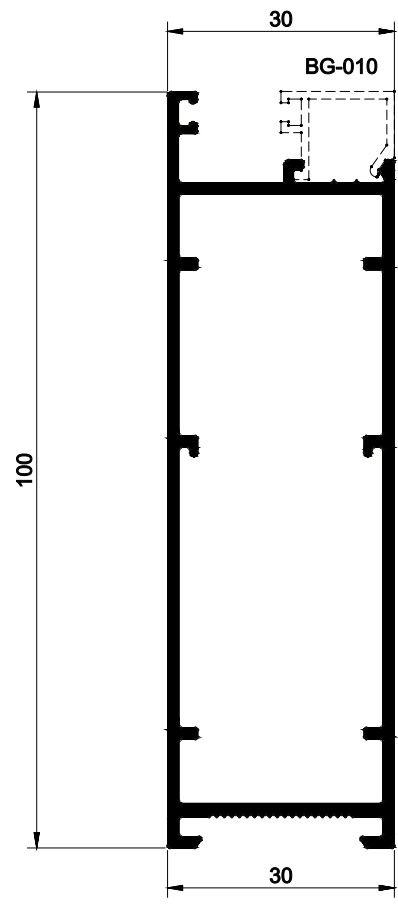
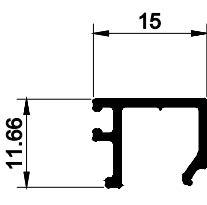
<p>FOLHA</p>  <p>E30-028 0,378 kg/m</p>	<p>FOLHA</p>  <p>E30-082 1,128 kg/m</p>
<p>BAGUETE</p>  <p>EBG-010 0,114 kg/m</p>	

TRAVESSA

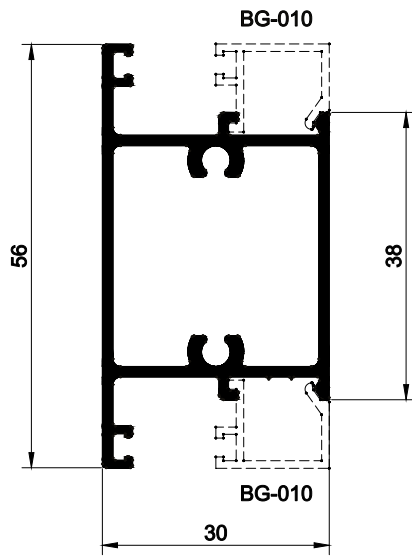

E30-025
0,718 kg/m

FOLHA

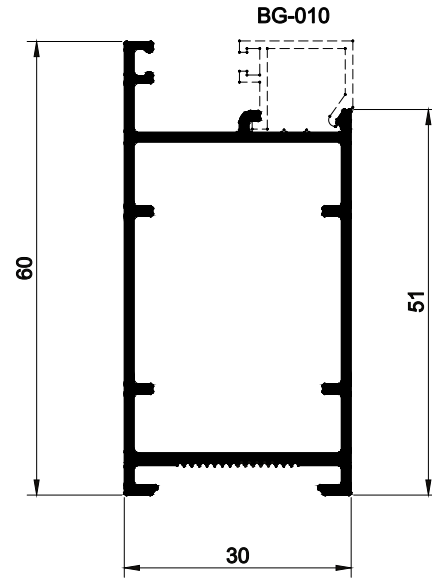

E30-026
0,694 kg/m

FOLHA

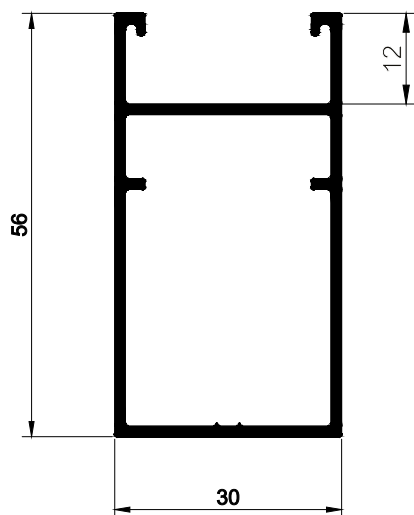

E30-014
0,680 kg/m

FOLHA

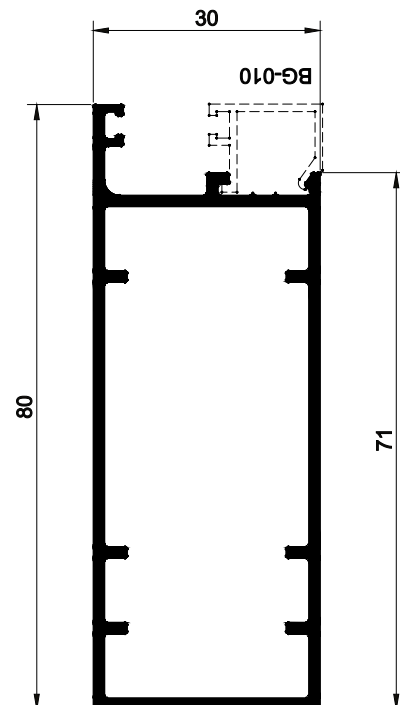

E30-033
0,944 kg/m

MARCO

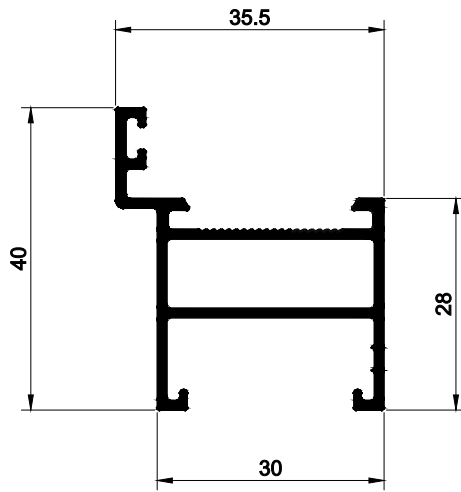

E30-023
0,525 kg/m

MARCO

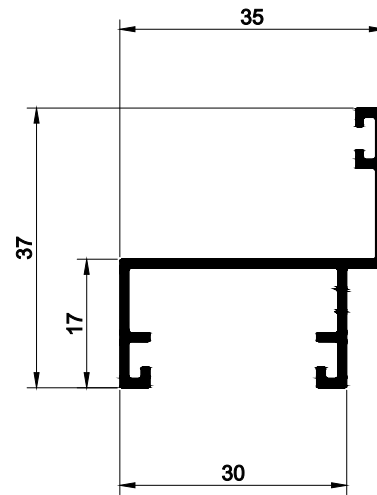

E30-054
0,352 kg/m

FOLHA

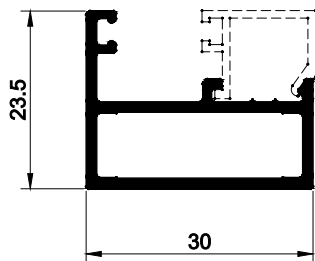

E30-051
0,385 kg/m

FOLHA

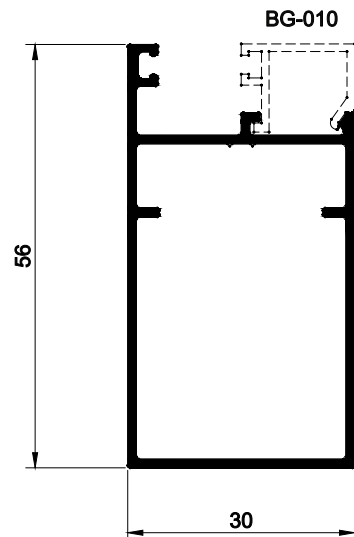

E30-008
0,550 kg/m

MARCO SUPERIOR 2 PLANOS / CORRER

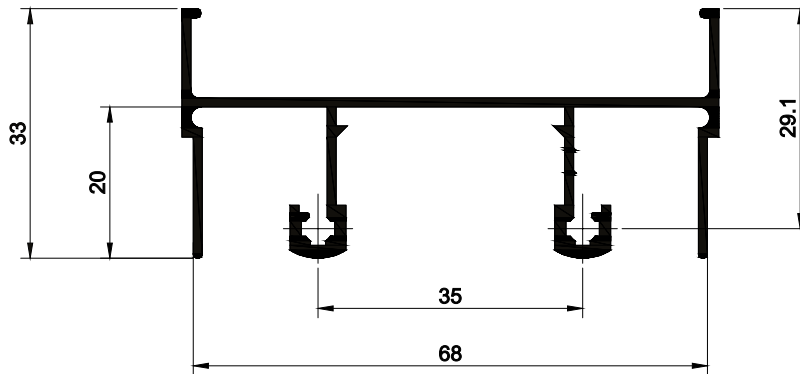
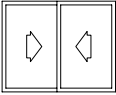

E90-001
0,719 kg/m

MARCO INFERIOR 2 PLANOS / CORRER

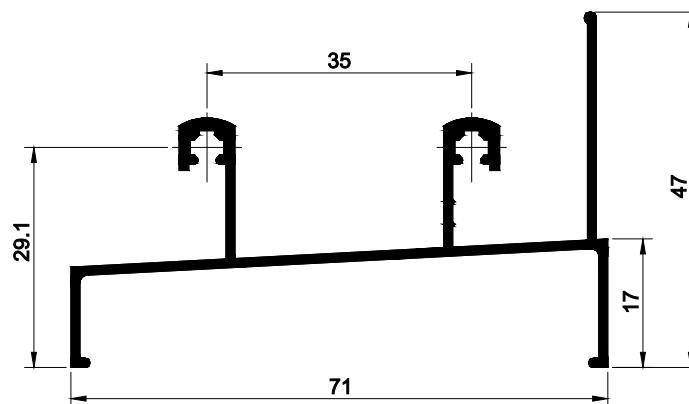
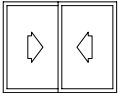

E90-002
0,663 kg/m

MARCO BANDEIRA E PEITORIL 2 PLANOS / CORRER

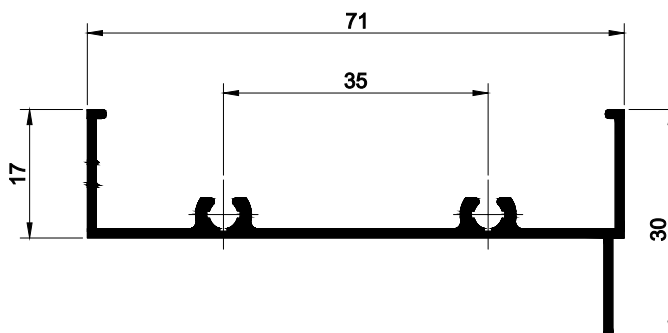
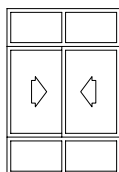

E90-004
0,470 kg/m

TRILHO SUPERIOR BANDEIRA E PEITORIL 2 PLANOS / CORRER

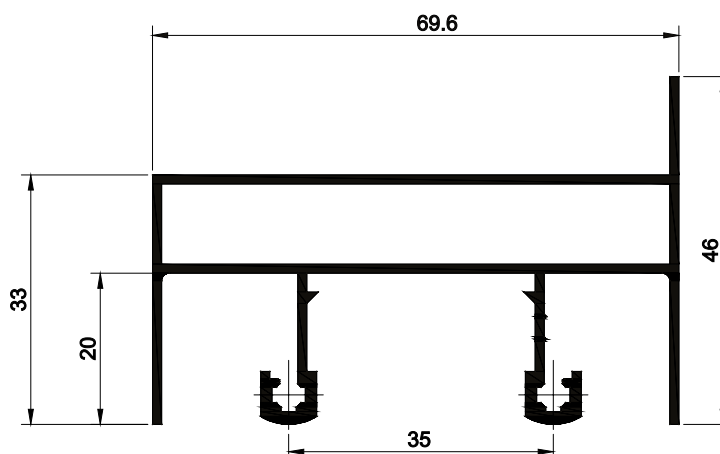
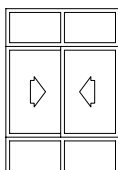

E90-005
0,955 kg/m

TRILHO INFERIOR BANDEIRA E PEITORIL 2 PLANOS / CORRER

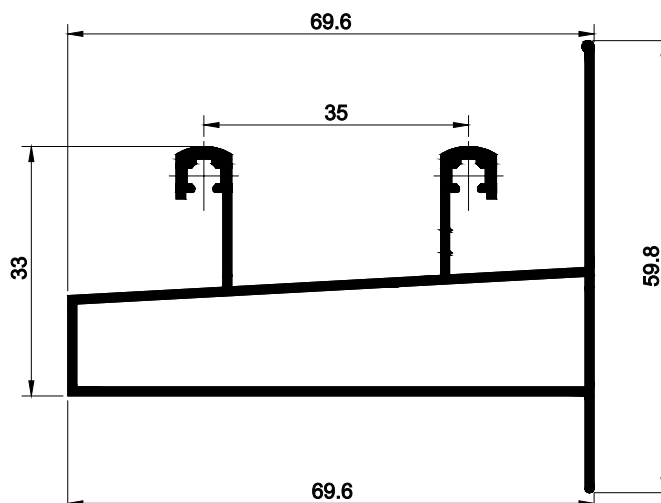
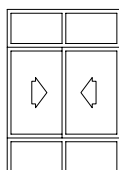

E90-006
0,908 kg/m

MARCO SUPERIOR 2 PLANOS / CORRER

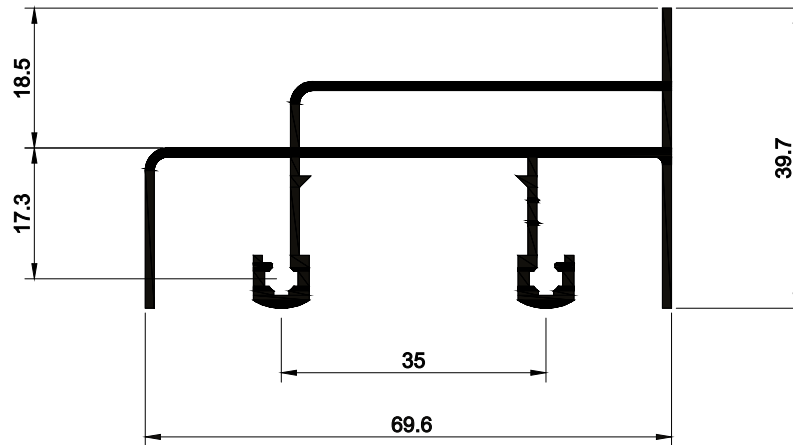
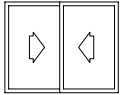

E90-205
0,854 kg/m

MARCO INFERIOR 2 PLANO / CORRER

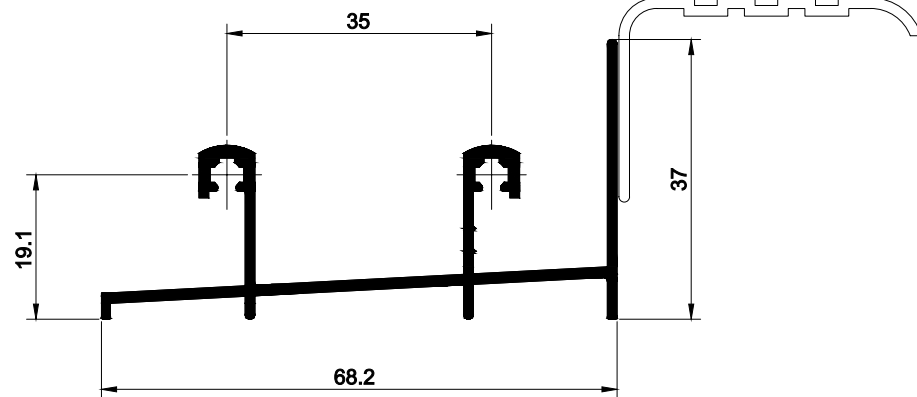
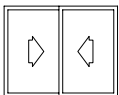

E90-228
0,656 kg/m

MARCO INFERIOR 2 PLANO / CORRER

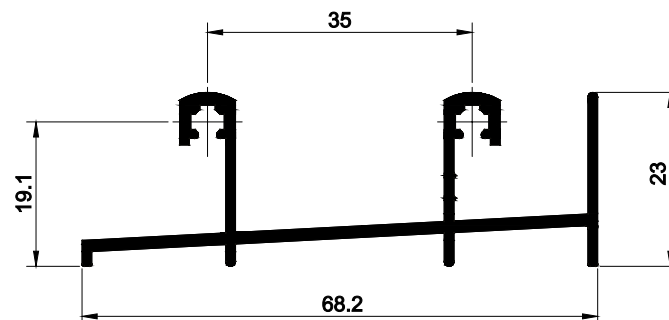
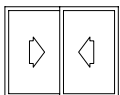

E90-260
0,653 kg/m

MARCO INFERIOR 2 PLANOS / CORRER

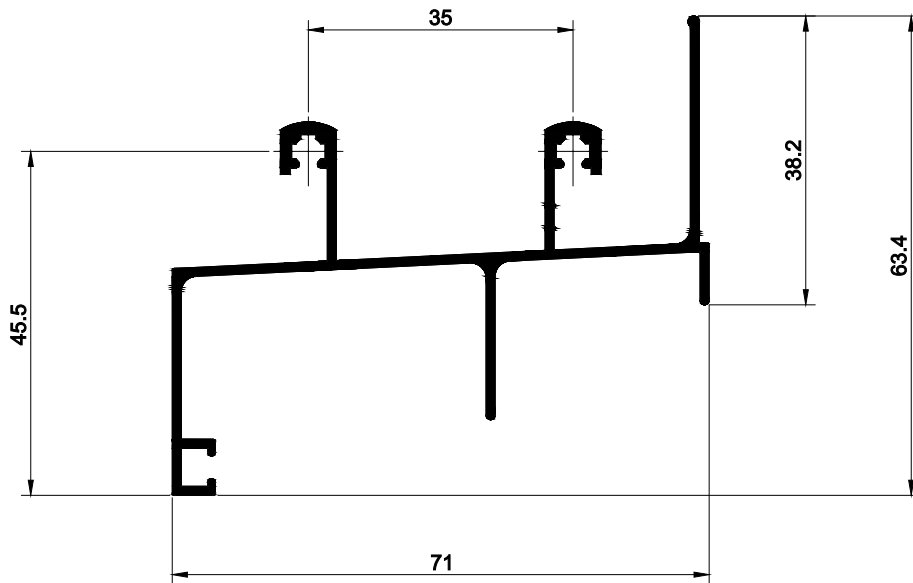
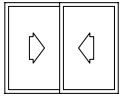

E90-251
0,787 kg/m

MARCO LATERAL COM MATA JUNTA 2 PLANOS / CORRER

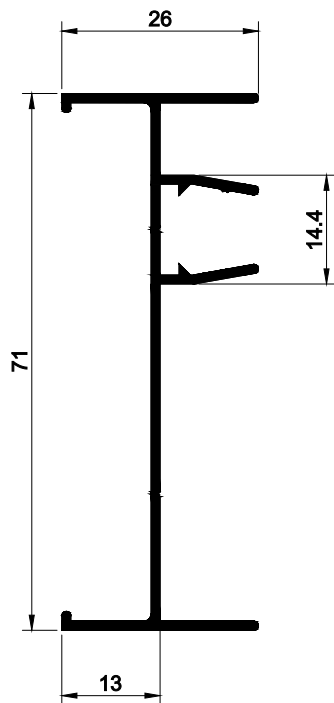
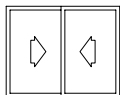

E90-003
0,491 kg/m

MARCO LATERAL SEM MATA JUNTA 2 PLANOS / CORRER

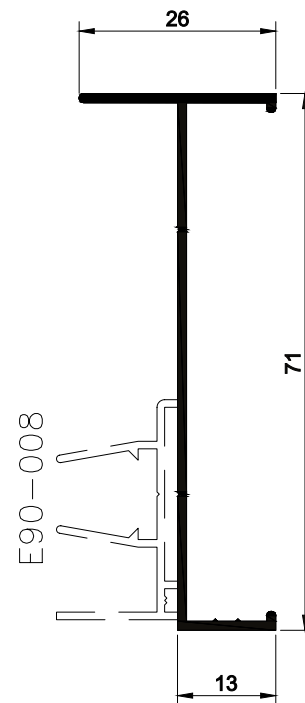
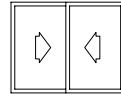

E90-007
0,357 kg/m

MARCO SUPERIOR 3 PLANOS BANDEIRA / CORRER

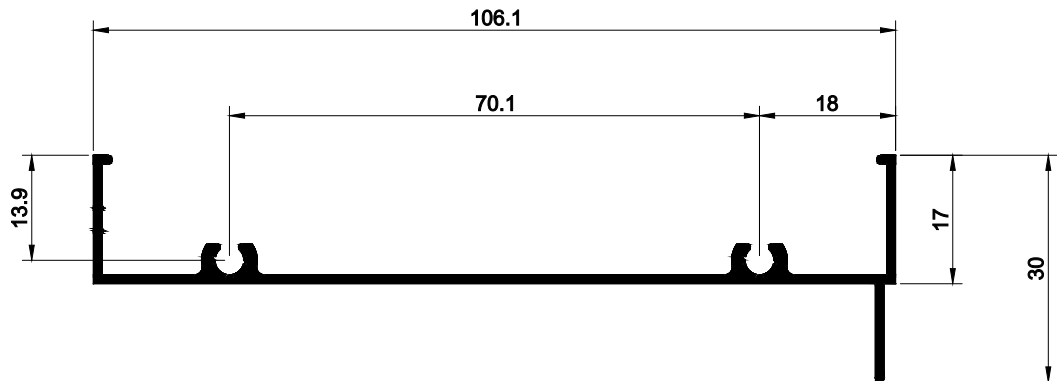
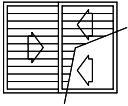

E90-018
0,584 kg/m

MARCO SUPERIOR 3 PLANOS BANDEIRA / CORRER

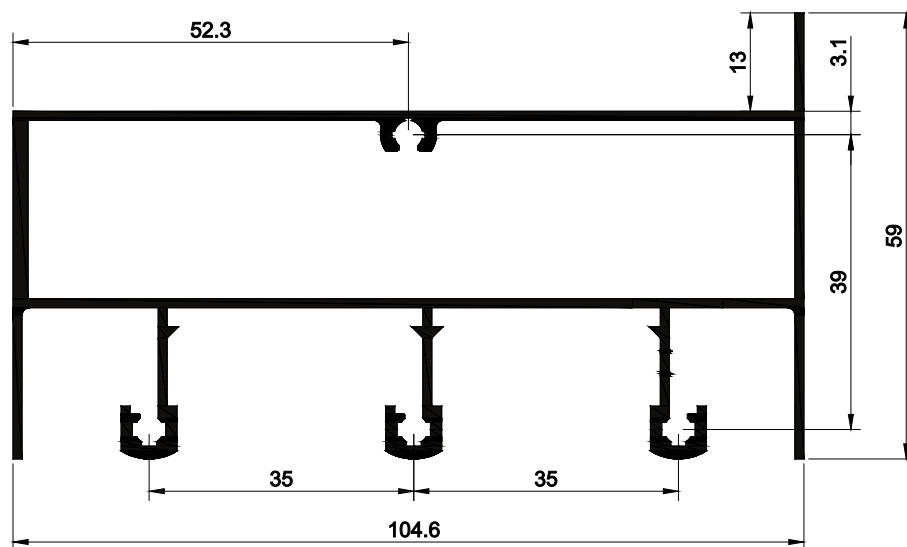
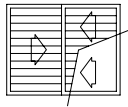

E90-019
1,49 kg/m

MARCO SUPERIOR 3 PLANOS / CORRER

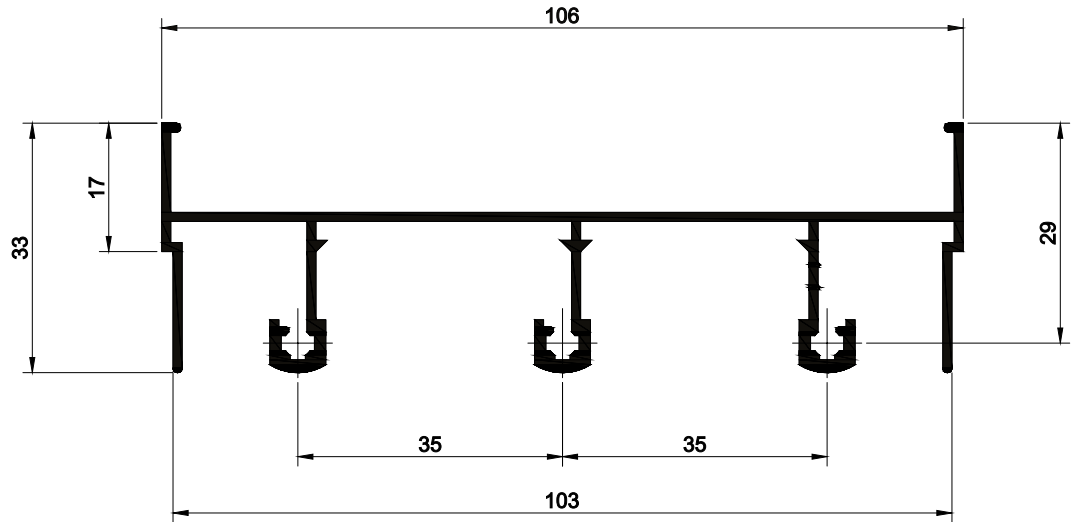
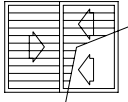

E90-010
0,960 kg/m

MARCO INFERIOR 3 PLANOS / CORRER

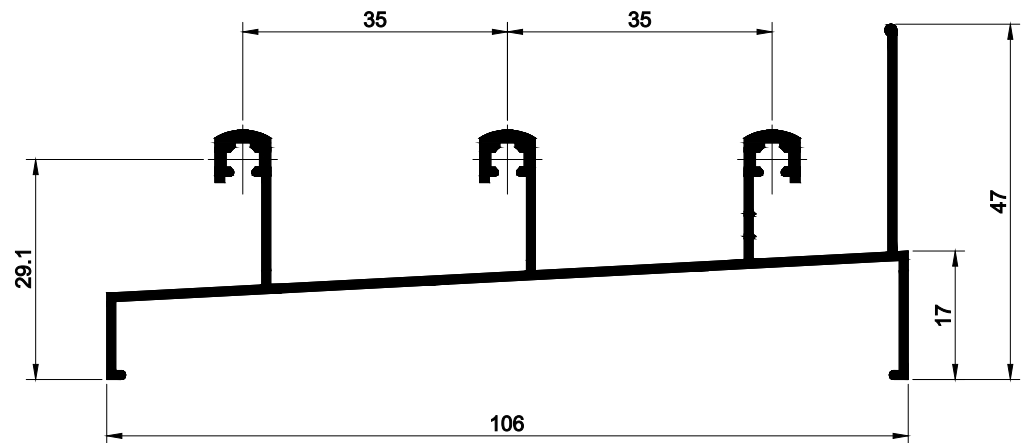
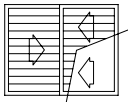

E90-011
0,894 kg/m

TRILHO INFERIOR BANDEIRA E PETTORIL 2 PLANOS / CORRER

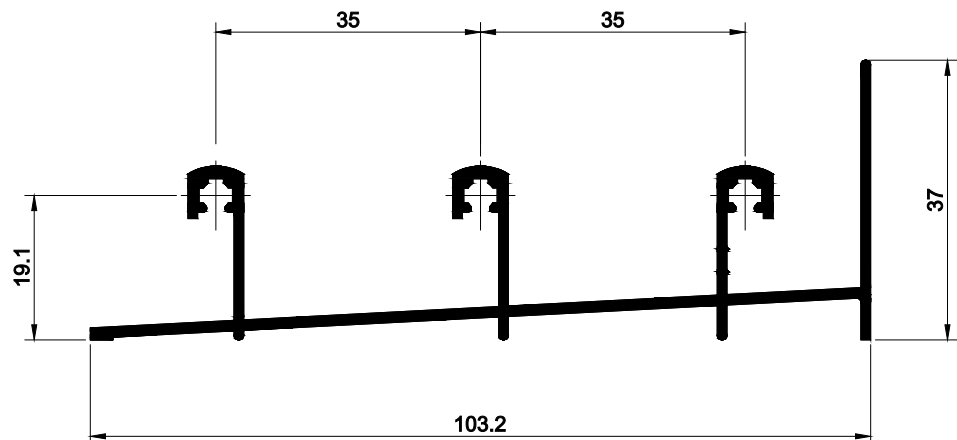
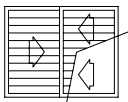

E90-230
0,916 kg/m

MARCO SUPERIOR 4 PLANOS / CORRER

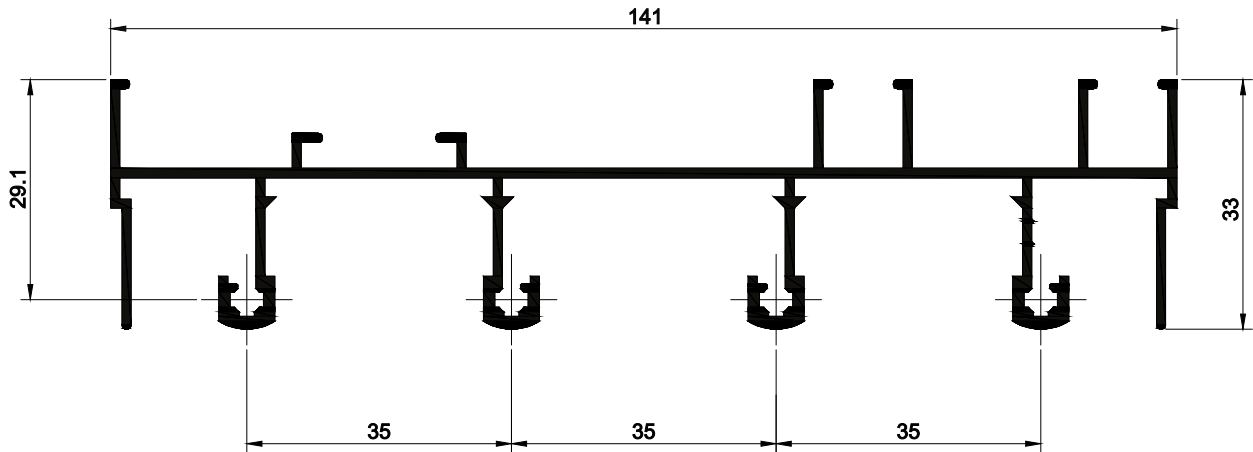
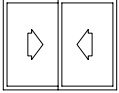

E90-121
1,417 kg/m

MARCO INFERIOR 4 PLANOS / CORRER

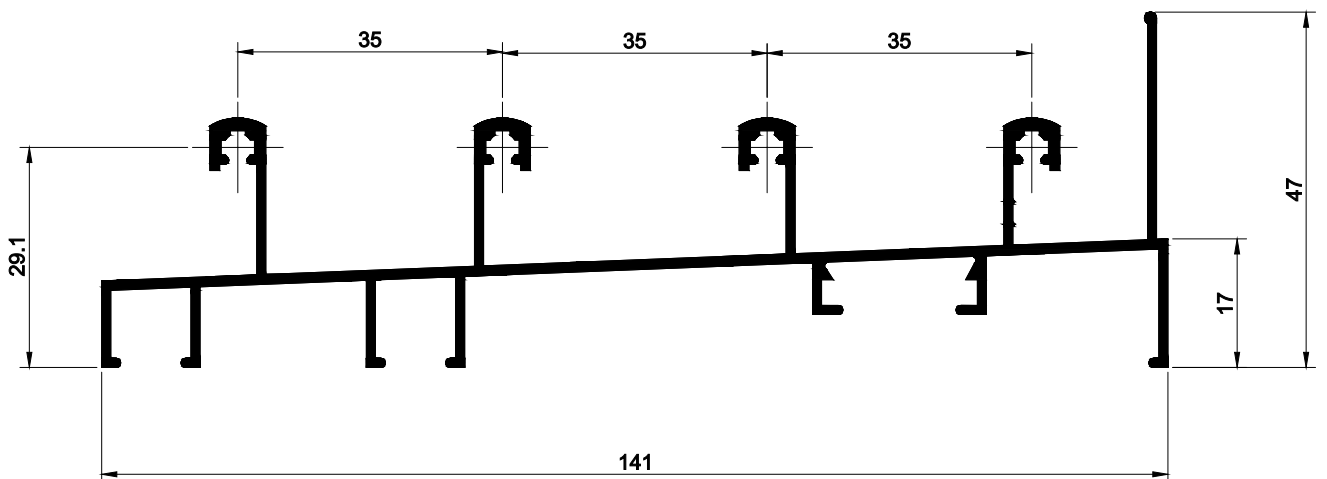
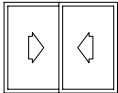

E90-122
1,365 kg/m

**MARCO LATERAL COM MATA JUNTA DUPLA
3 PLANOS / CORRER**

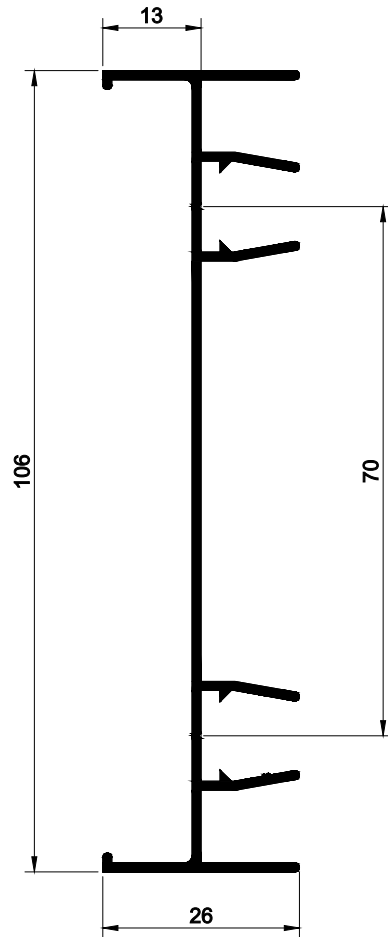
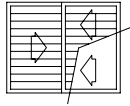

E90-013
0,695 kg/m

**MARCO LATERAL SEM MATA JUNTA
3 PLANOS / CORRER**

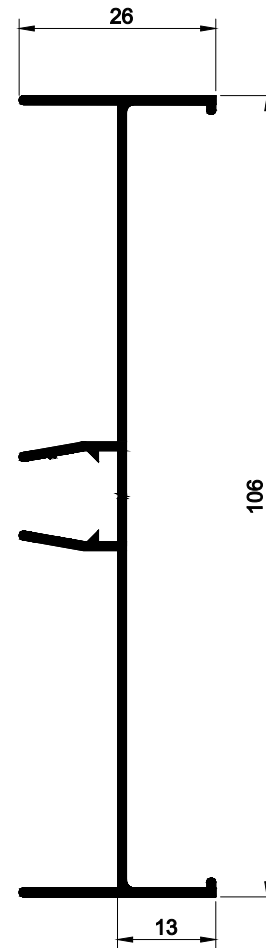
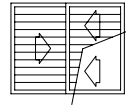

E90-014
0,605 kg/m

MARCO LATERAL SEM MATA JUNTA

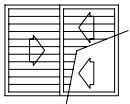

E90-012
0,609 kg/m

MARCO INFERIOR 4 PLANOS / CORRER

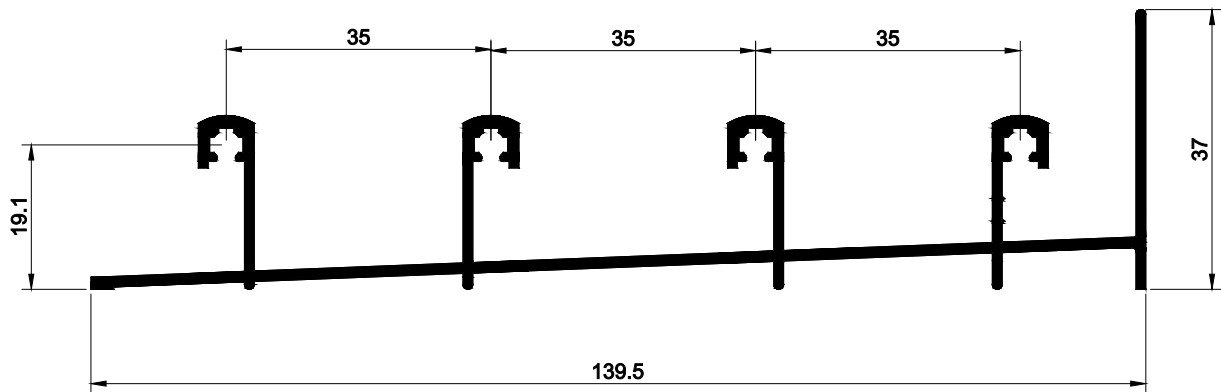
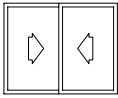

E90-222
1,178kg/m

TRILHO INFERIOR 2 PLANOS INTEGRADA / CORRER

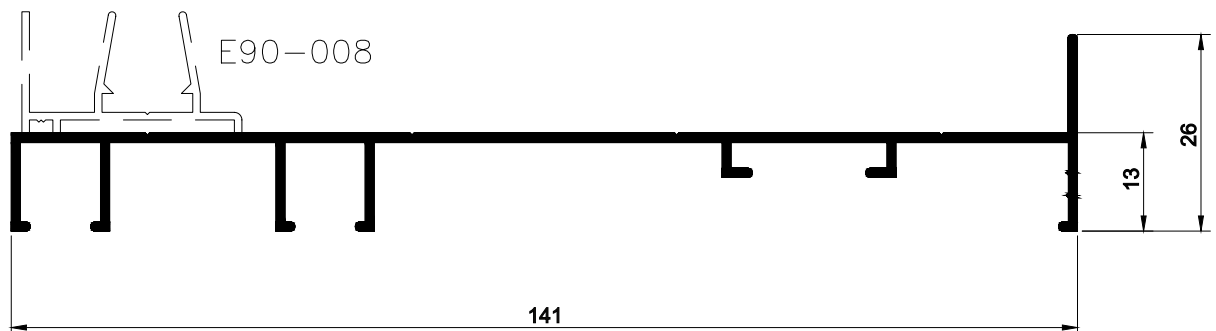
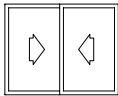

E90-123
0,800kg/m

MONTANTE LATERAL / CORRER

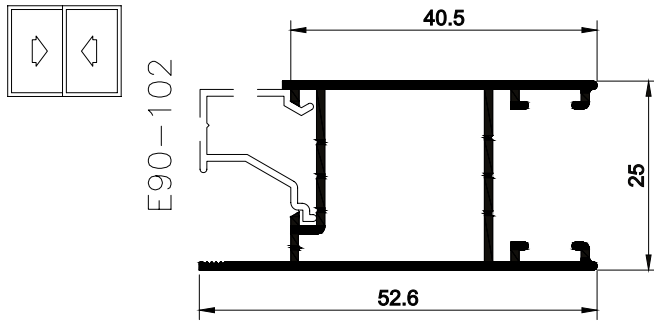

E90-039
0,475 kg/m

MONTANTE LATERAL FEC CENTRAL / CORRER

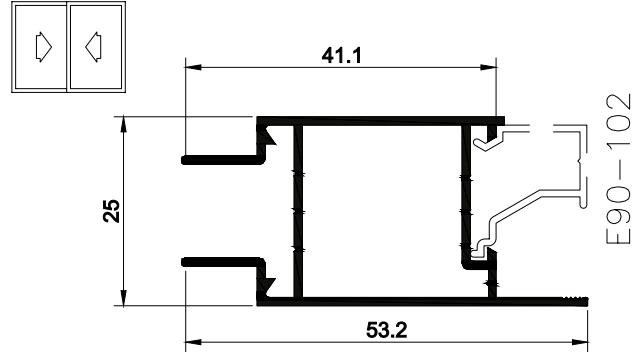

E90-192
0,475 kg/m

MONTANTE LATERAL / CORRER

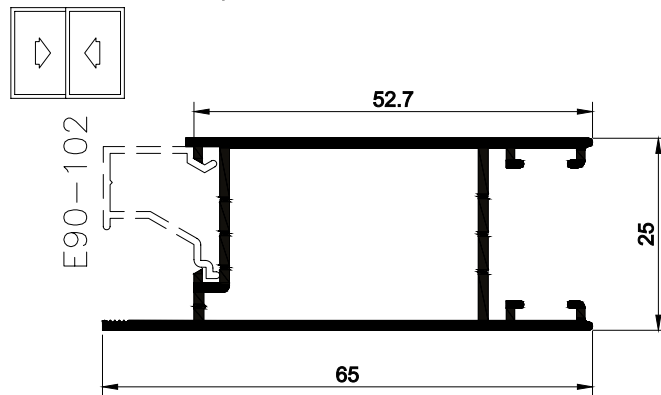

E90-245
0,635 kg/m

MONTANTE LATERAL / CORRER

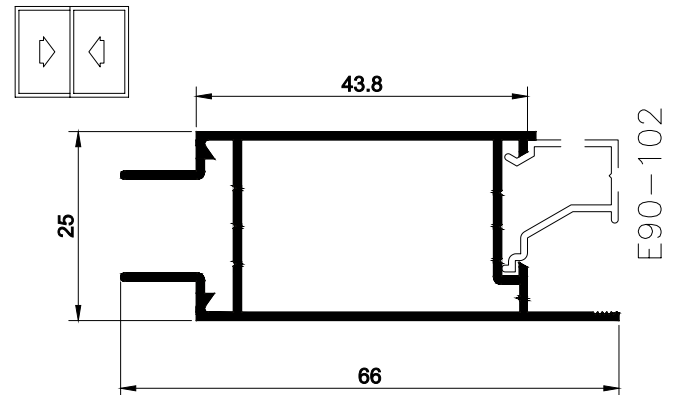

E90-601
0,548 kg/m

MONTANTE LATERAL COM REFORÇO / CORRER

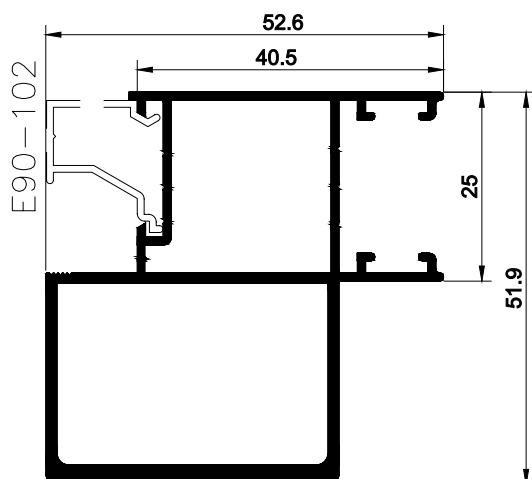

E90-044
0,972 kg/m

MONTANTE LATERAL / CORRER

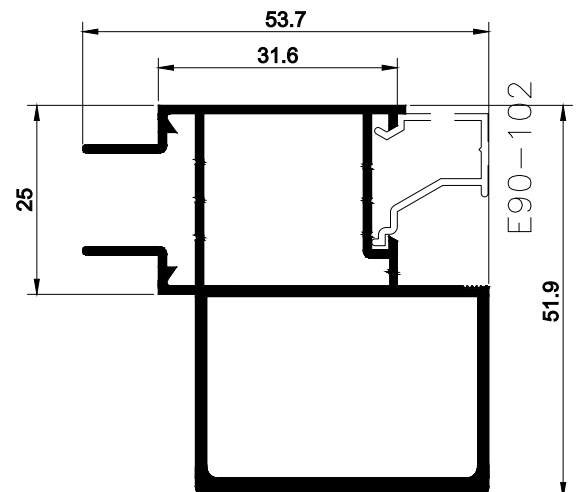

E90-043
0,976 kg/m

MONTANTE MÃO DE AMIGO / CORRER

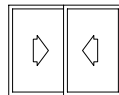
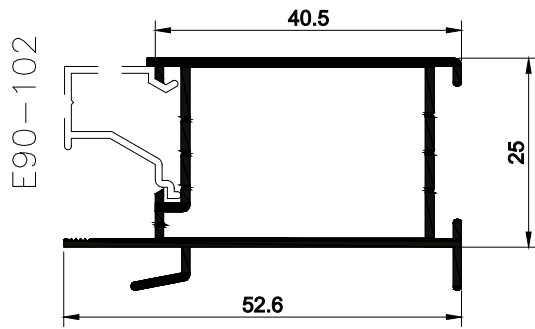

E90-282
0,526kg/m

MONTANTE MÃO DE AMIGO / CORRER

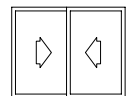
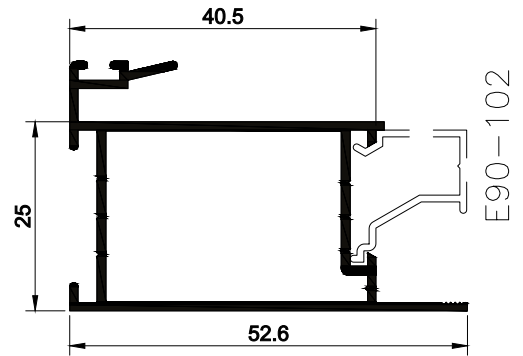

E90-283
0,550 kg/m

MONTANTE MÃO DE AMIGO / CORRER

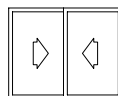
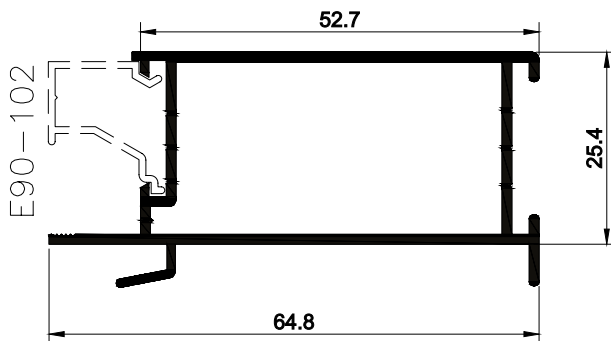

E90-243
0,663 kg/m

MONTANTE MÃO DE AMIGO / CORRER

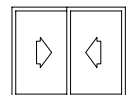
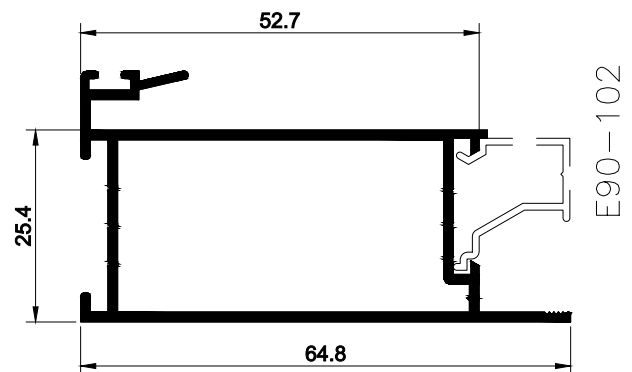

E90-242
0,693 kg/m

MONTANTE MÃO DE AMIGO REF / CORRER

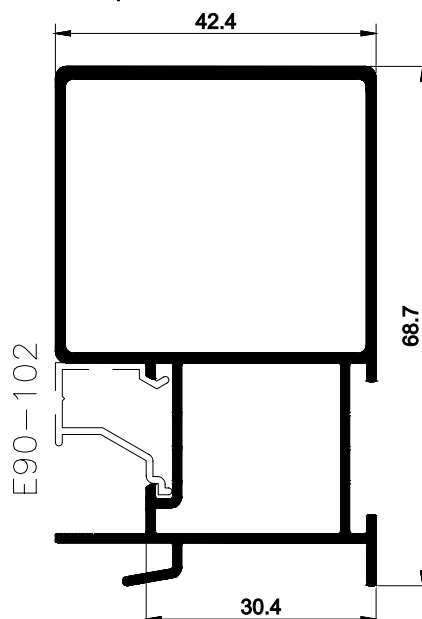
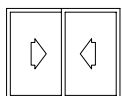

E90-047
0,974 kg/m

TRAVESSA / CORRER

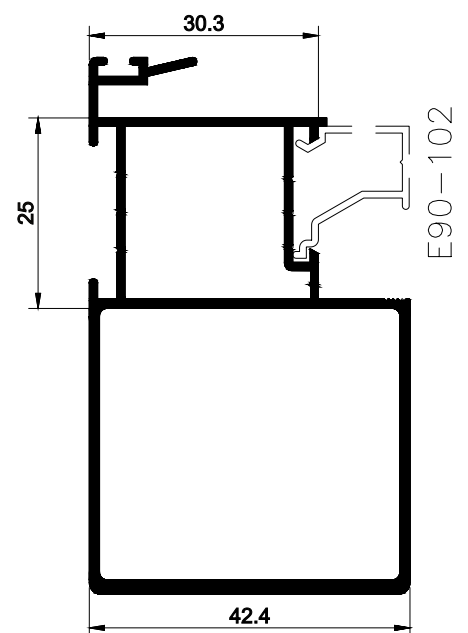
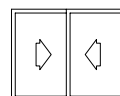

E90-049
0,970 kg/m

MONTANTE LATERAL / CORRER

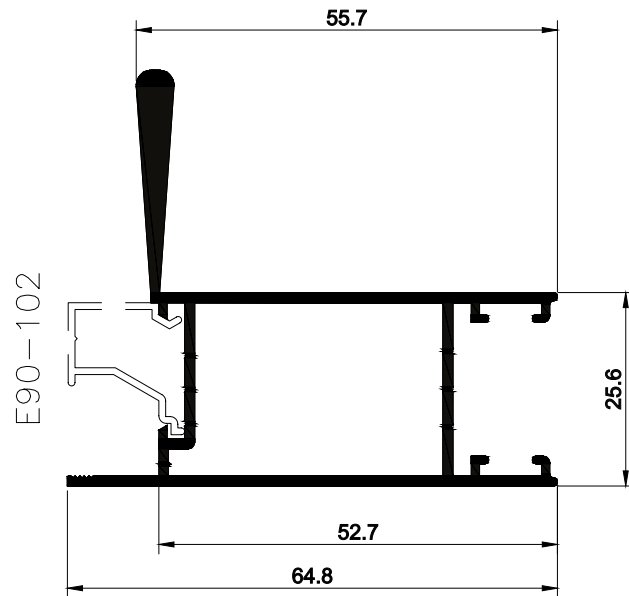
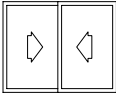

E90-280
0,912 kg/m

MONTANTE LATERAL / CORRER

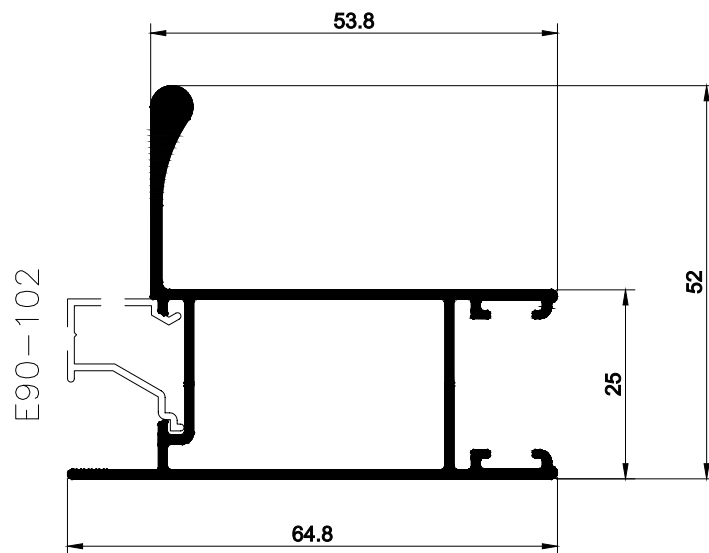
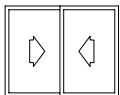

E90-609
0,789 kg/m

MONTANTE MÃO DE AMIGO / CORRER

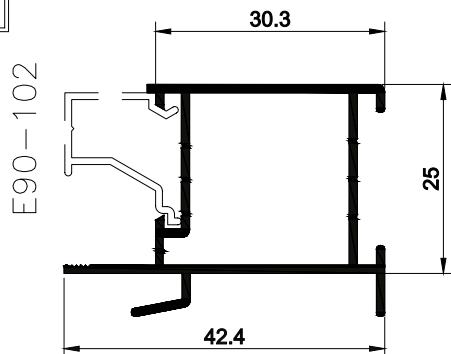
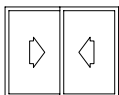

E90-040
0,435 kg/m

MONTANTE MÃO DE AMIGO / CORRER

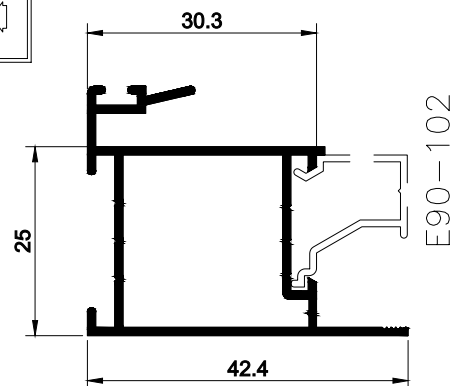
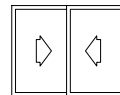

E90-041
0,463 kg/m

TRAVESSA / CORRER

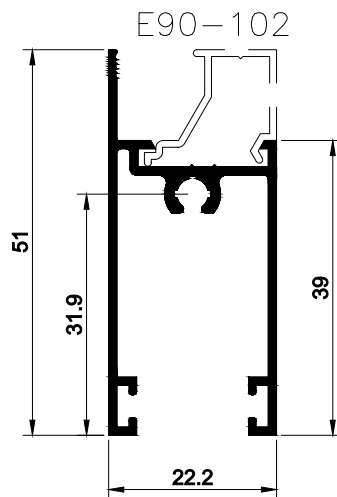
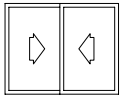

E90-053
0,439 kg/m

TRAVESSA CENTRAL / CORRER

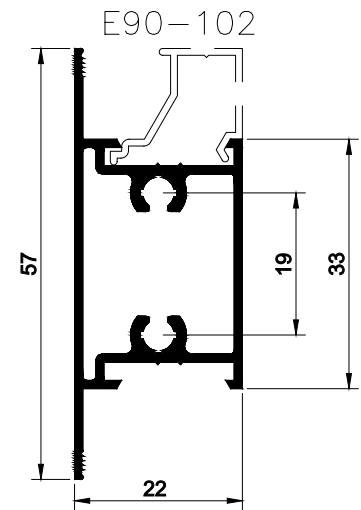
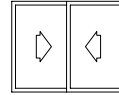

E90-227
0,525 kg/m

TRAVESSA / CORRER

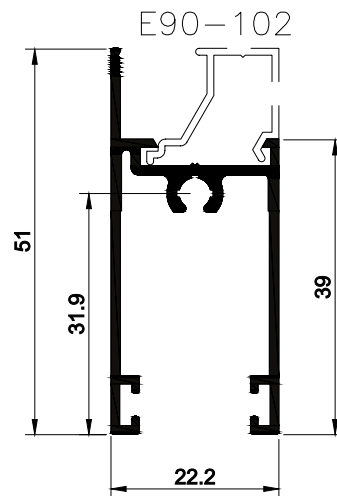
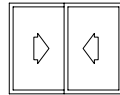

E90-153
0,484 kg/m

TRAVESSA / CORRER

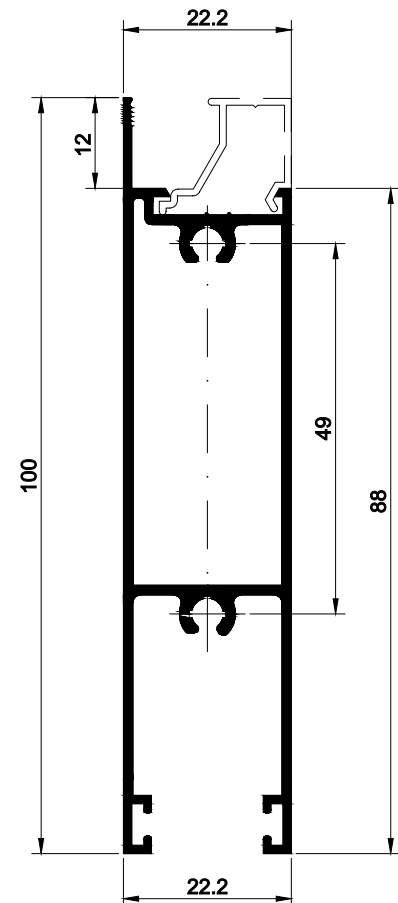
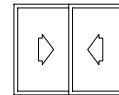

E90-225
0,941 kg/m

MONTANTE MÃO DE AMIGO / CORRER

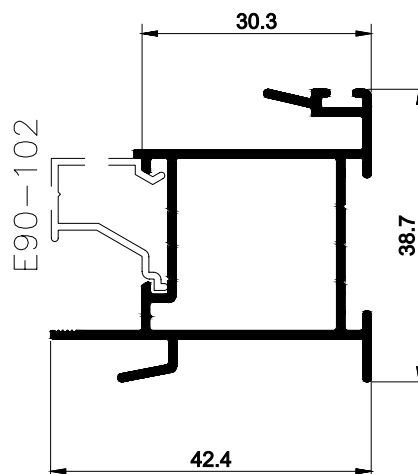
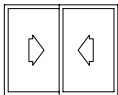

E90-042
0,514 kg/m

MONTANTE LATERAL SEM BAGUETE / CORRER

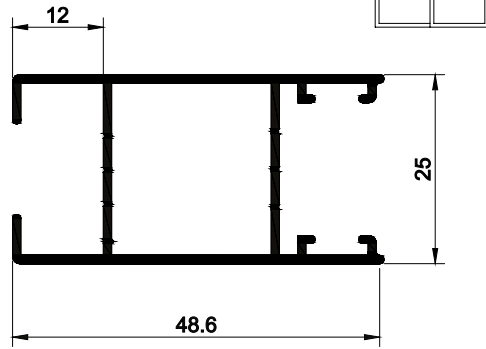

E90-055
0,499 kg/m

MONTANTE LATERAL SEM BAGUETE / CORRER

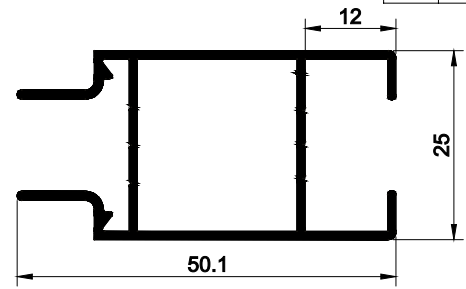

E90-190
0,506 kg/m

MONTANTE LATERAL SEM BAGUETE / CORRER

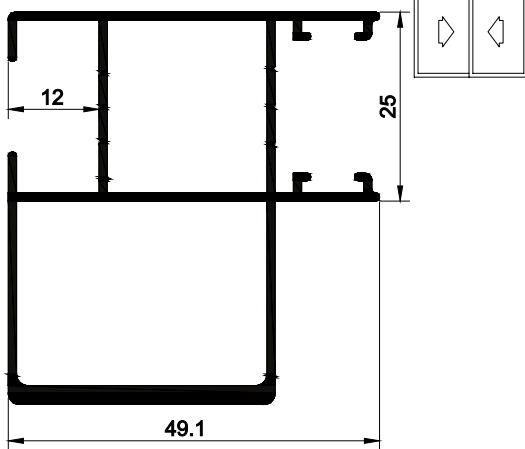

E90-060
0,883 kg/m

MONTANTE LATERAL SEM BAGUETE / CORRER

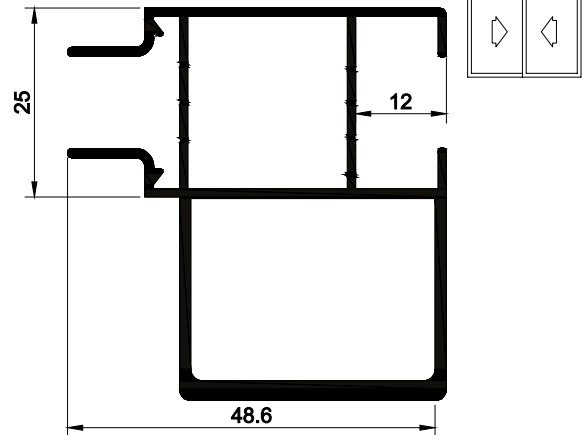

E90-059
0,969 kg/m

MONTANTE LATERAL SEM BAGUETE / CORRER

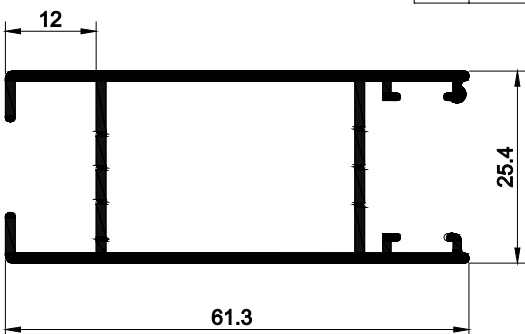

E90-238
0,669 kg/m

MONTANTE LATERAL SEM BAGUETE / CORRER

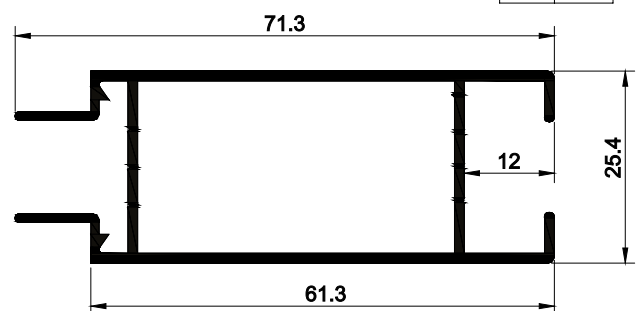

E90-240
0,669 kg/m

MONTANTE MÃO DE AMIGO SEM BAGUETE / CORRER

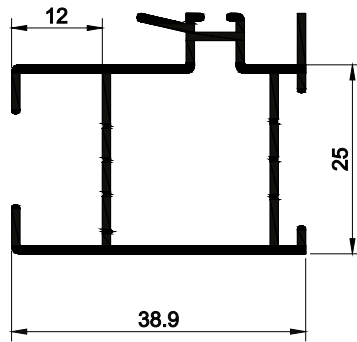
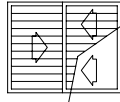

E90-056
0,496 kg/m

MONTANTE MÃO DE AMIGO SEM BAGUETE REF / CORRER

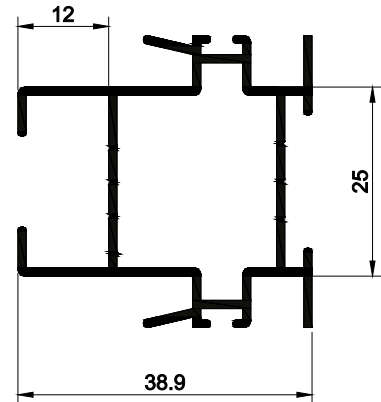
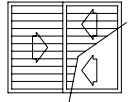

E90-057
0,582 kg/m

MONTANTE MÃO DE AMIGO SEM BAGUETE / CORRER

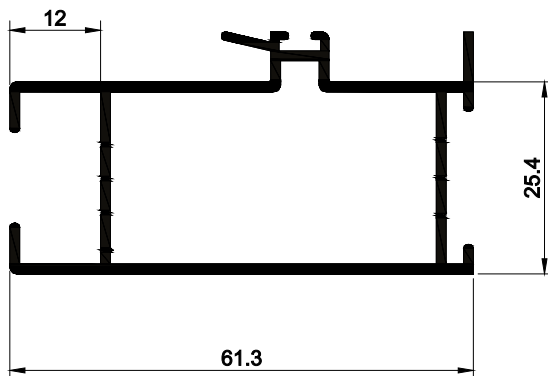
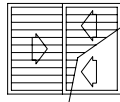

E90-239
0,734 kg/m

MONTANTE MÃO DE AMIGO SEM BAGUETE REF / CORRER

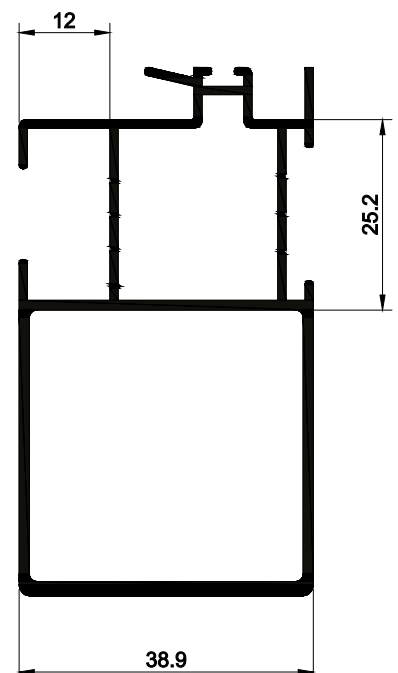
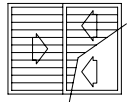

E90-061
0,981 kg/m

TRAVESSA SEM BAGUETE / CORRER

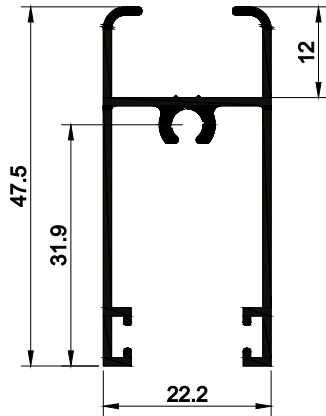
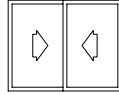

E90-186
0,484 kg/m

TRAVESSA SEM BAGUETE / CORRER

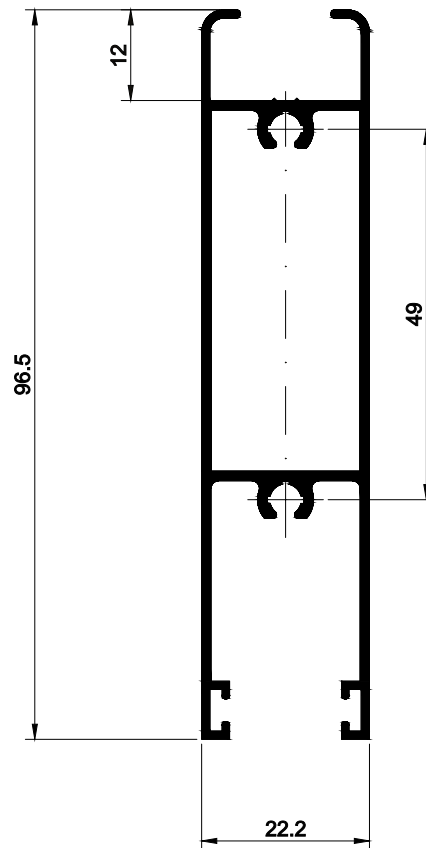
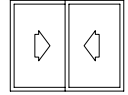

E90-226
0,954 kg/m

TRAVESSA CENTRAL SEM BAGUETE / CORRER

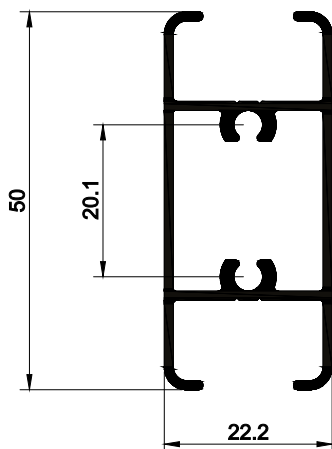
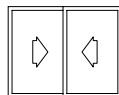

E90-188
0,579 kg/m

TAMPA EXTERNA PORTA / INTEGRADA

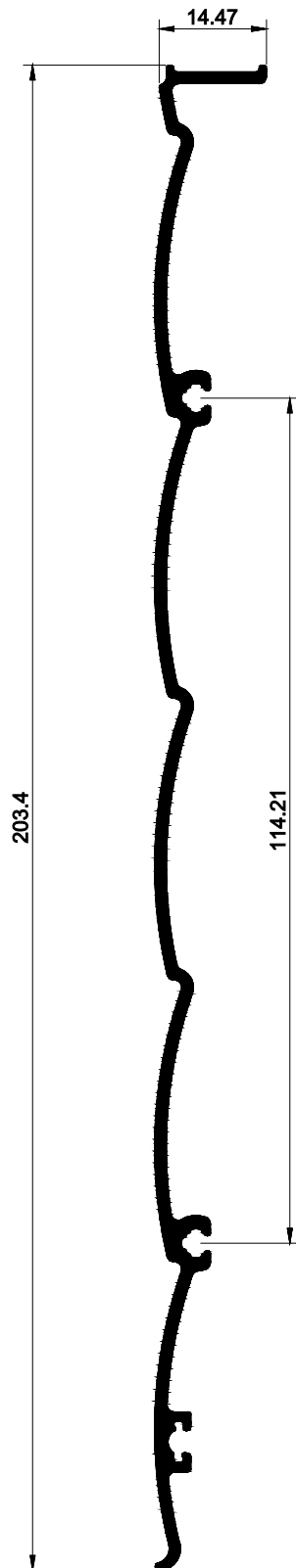

E90-607
1,106 kg/m

TAMPA INTERNA JANELA / INTEGRADA

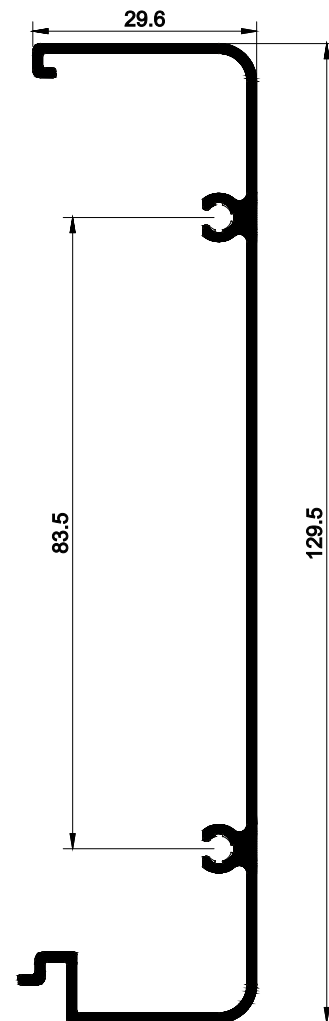
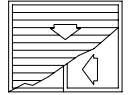

E90-608
0,818 kg/m

MONTANTE LATERAL / CORRER

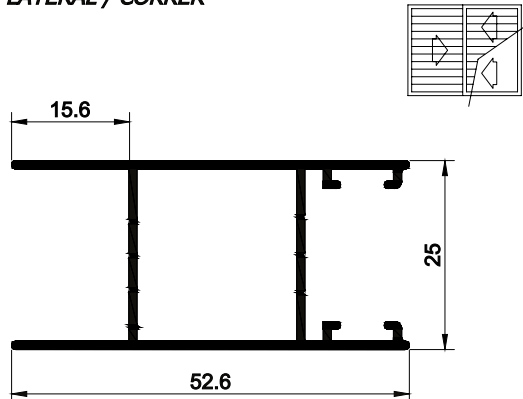

E90-068
0,489 kg/m

MONTANTE LATERAL / CORRER

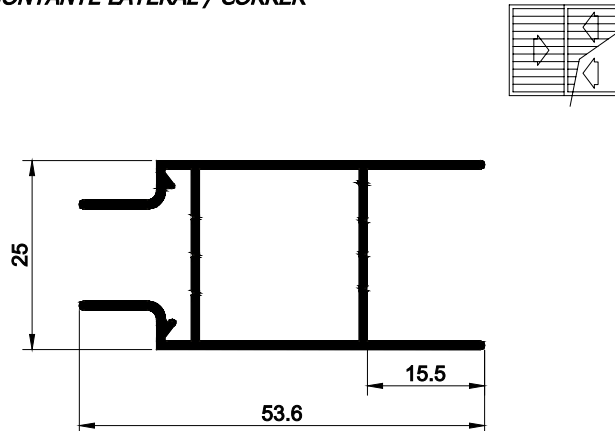

E90-191
0,496 kg/m

MONTANTE MÃO DE AMIGO / CORRER

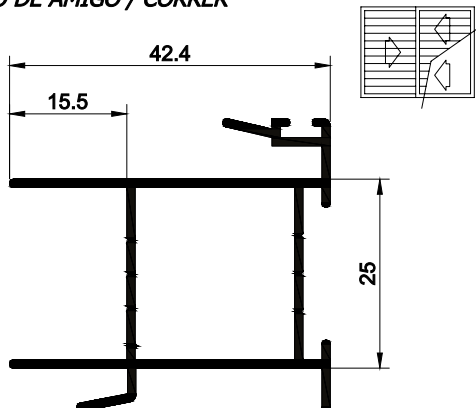

E90-069
0,525 kg/m

MONTANTE MÃO DE AMIGO / CORRER

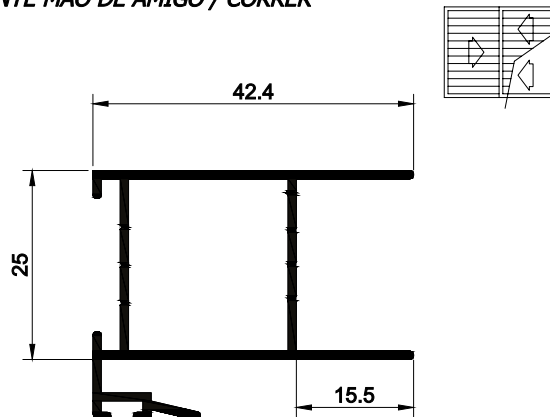

E90-070
0,480 kg/m

MONTANTE LATERAL / CORRER

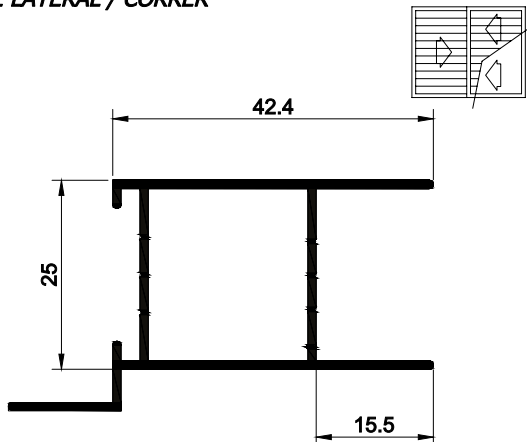

E90-074
0,458 kg/m

TRAVESSA / CORRER

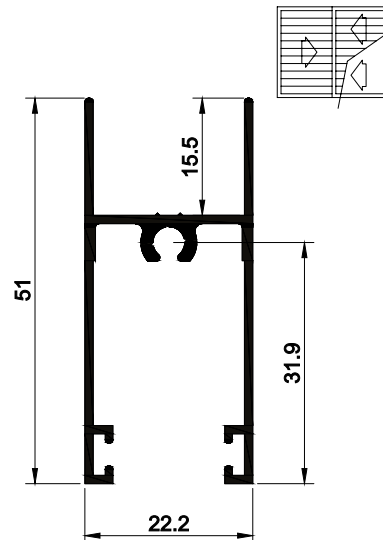

E90-187
0,466 kg/m

MARCO / GIRO

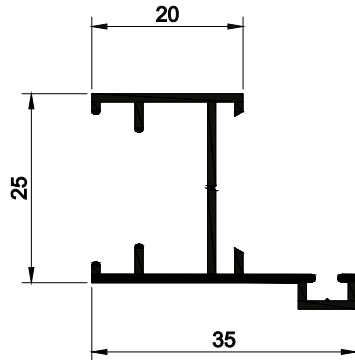
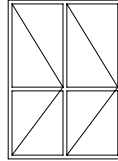

E90-079
0,305 kg/m

MONTANTE FOLHA SEM BAGUETE/ GIRO

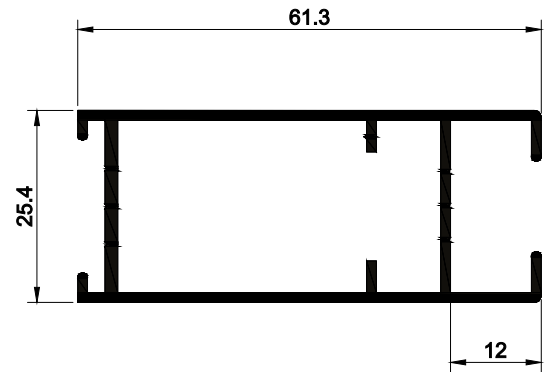
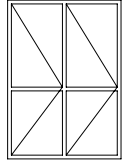

E90-241
0,699 kg/m

MONTANTE FOLHA/ GIRO

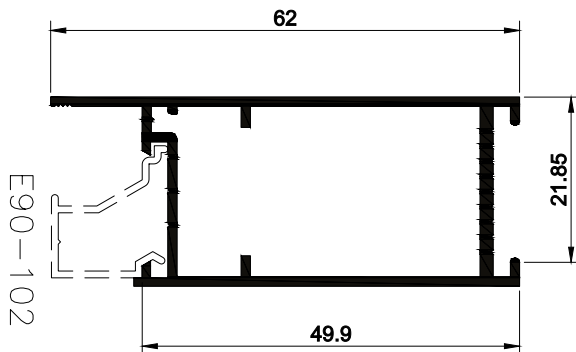
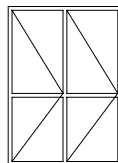

E90-111
0,597 kg/m

MONTANTE FOLHA/ GIRO

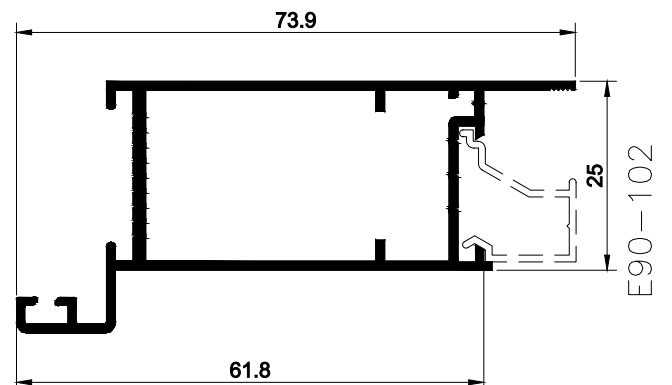
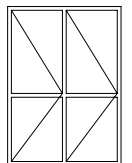

E90-113
0,688 kg/m

TRAVESSA CENTRAL / CORRER E GIRO

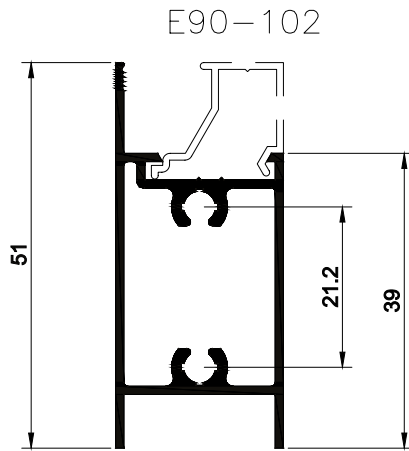
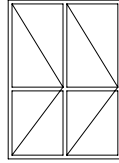

TRAVESSA CENTRAL / CORRER E GIRO

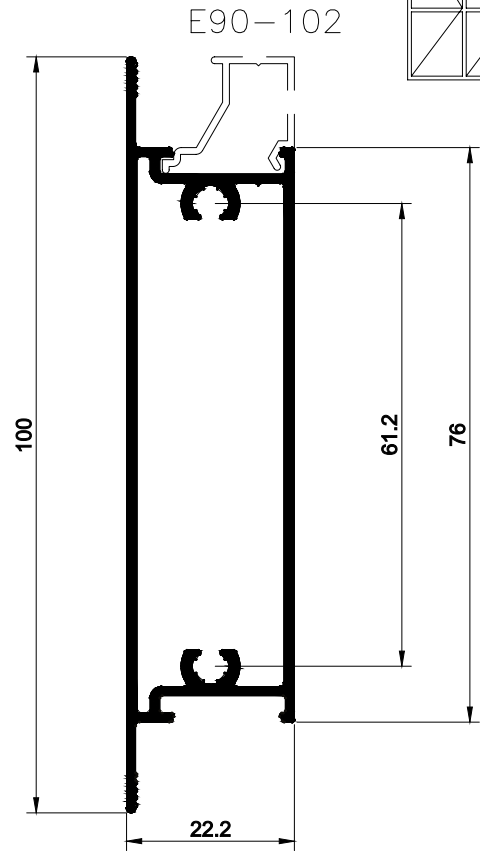
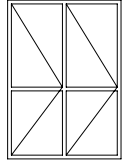

E90-110
0,507 kg/m

MARCO / MAXIM-AR

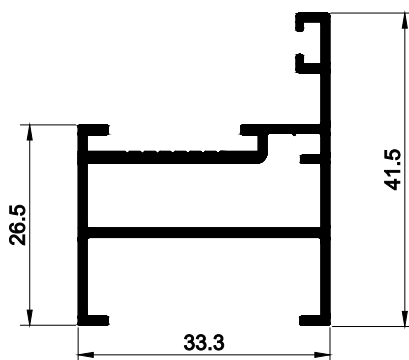

E90-050
0,920 kg/m

TRAVESSA SUPERIOR / MAXIM-AR

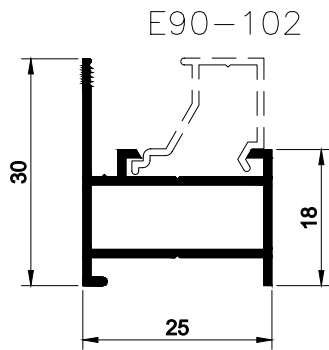

E90-580
0,304 kg/m

TRAVESSA / MAXIM-AR

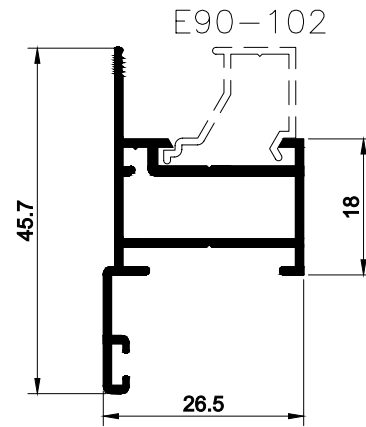

E90-600
0,397 kg/m

TRAVESSA / MAXIM-AR

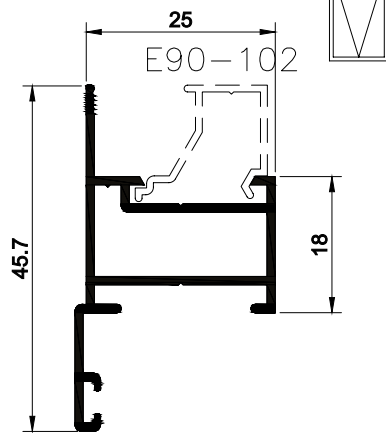

E90-200
0,381 kg/m

TRAVESSA / MAXIM-AR

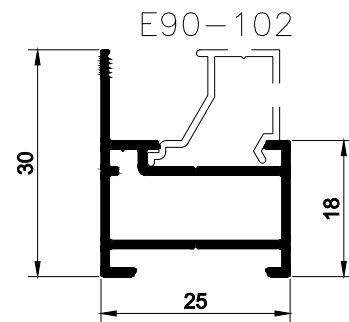

E90-080
0,318 kg/m

TRAVESSA / MAXIM-AR

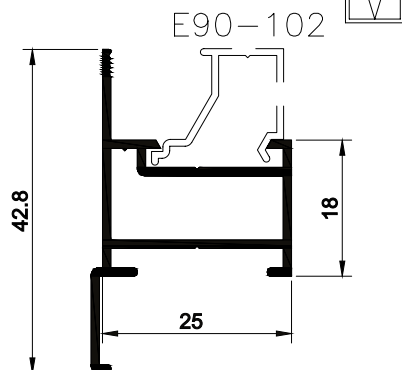

E90-081
0,360 kg/m

TRAVESSA SEM BAGUETE / MAXIM-AR

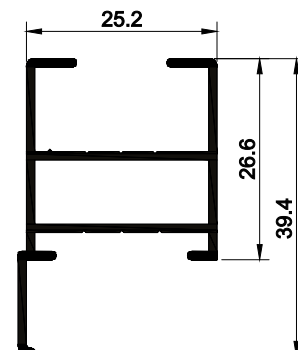

E90-090
0,384 kg/m

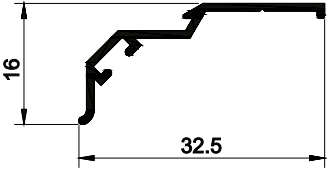
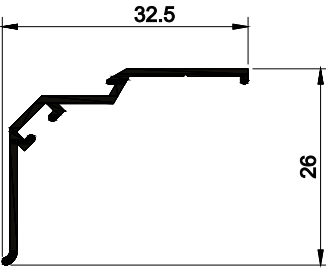
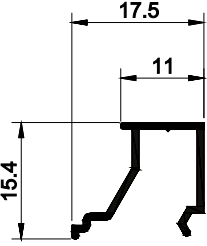
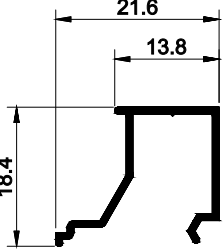
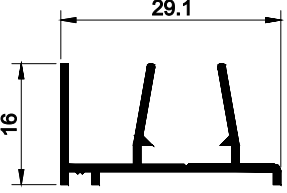
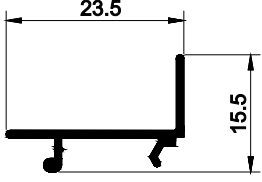
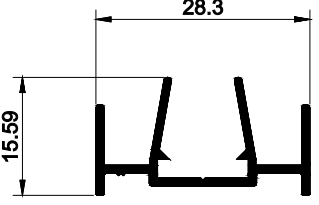
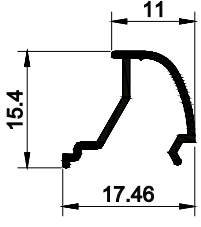
<p>PINGADEIRA / MAXIM-AR</p>  <p>E90-083 0,139 kg/m</p>	<p>PINGADEIRA / MAXIM-AR</p>  <p>E90-276 0,165 kg/m</p>
<p>BAGUETE</p>  <p>E90-102 0,125 kg/m</p>	<p>BAGUETE</p>  <p>E90-103 0,138 kg/m</p>
<p>MATA JUNTA POSTIÇO MARCO / CORRER</p>  <p>E90-008 0,206 kg/m</p>	<p>BAGUETE ADAPTADOR VENEZIANA</p>  <p>E90-108 0,138 kg/m</p>
<p>MATA JUNTA POSTIÇO FOLHA / CORRER</p>  <p>E90-291 0,491 kg/m</p>	<p>BAGUETE</p>  <p>E90-102R 0,104 kg/m</p>

TRAVESSA SUPERIOR SEM BAGUETE / MAXIM-AR

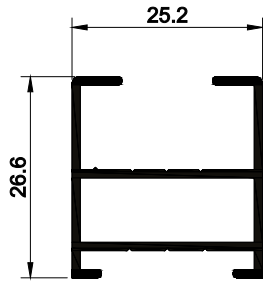

E90-091
0,341 kg/m

TRAVESSA / MAXIM-AR

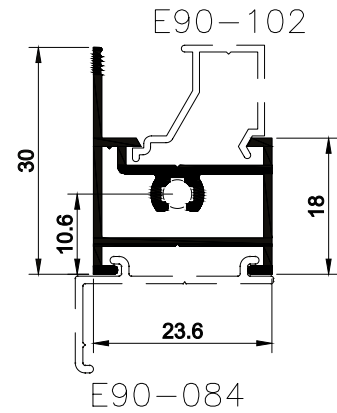

E90-082
0,345 kg/m

TRAVESSA / MAXIM-AR

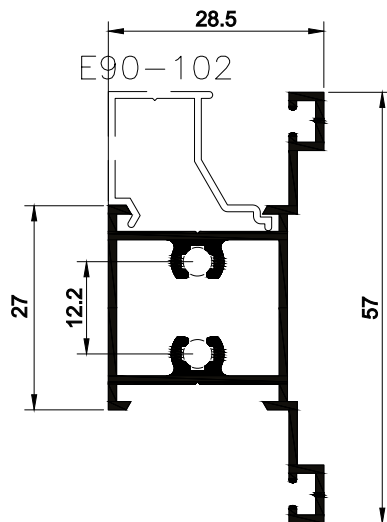
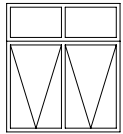

E90-086
0,563 kg/m

TRAVESSA / MAXIM-AR

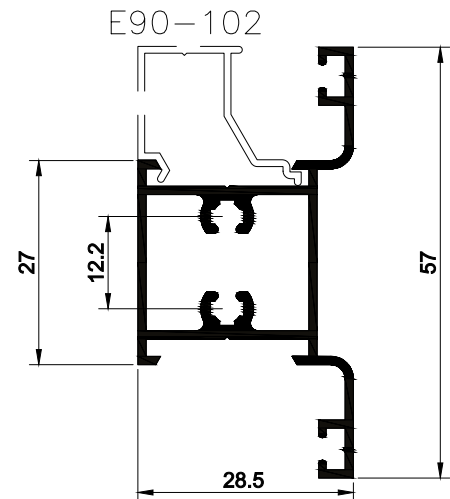
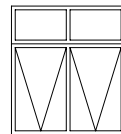

E90-586
0,577 kg/m

COLUNA / MAXIM-AR

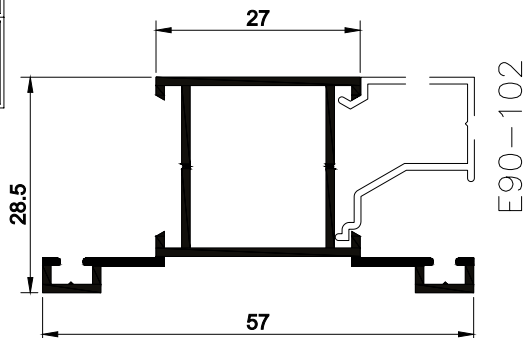
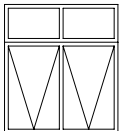

E90-085
0,461 kg/m

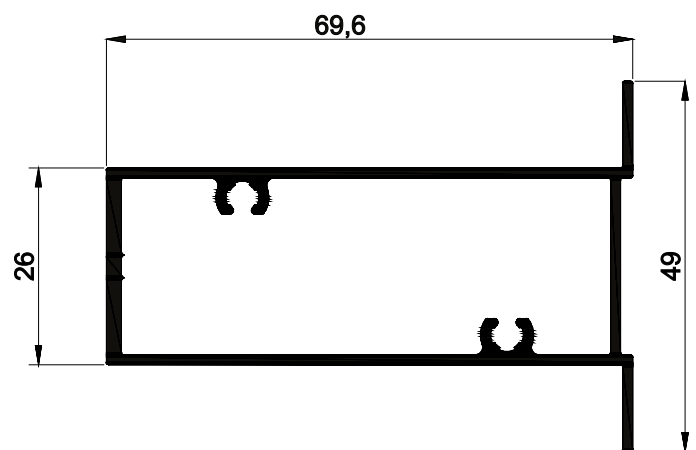

E90-009
0,867 kg/m

MARCO SUPERIOR 30 / CORRER

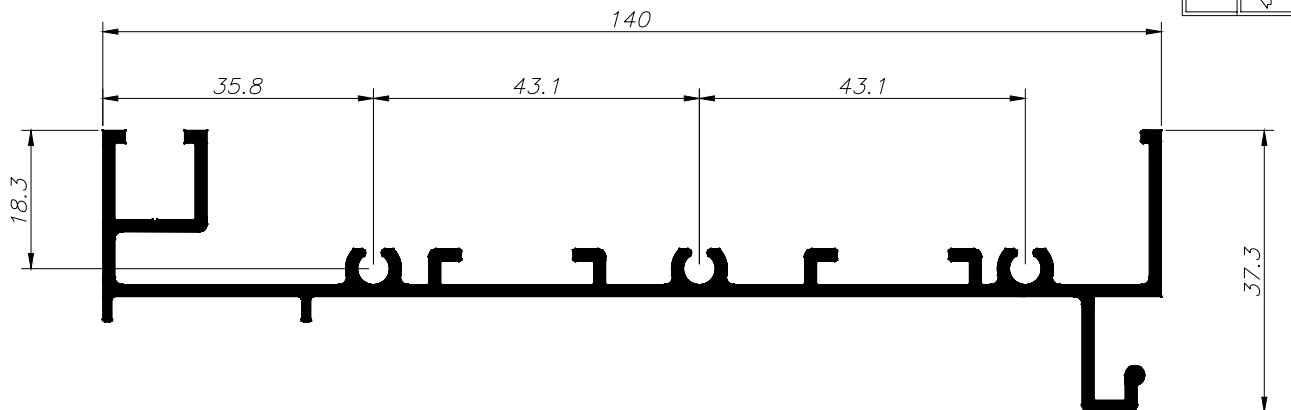

EMN-001
1,314 kg/m

MARCO LATERAL 30 / CORRER

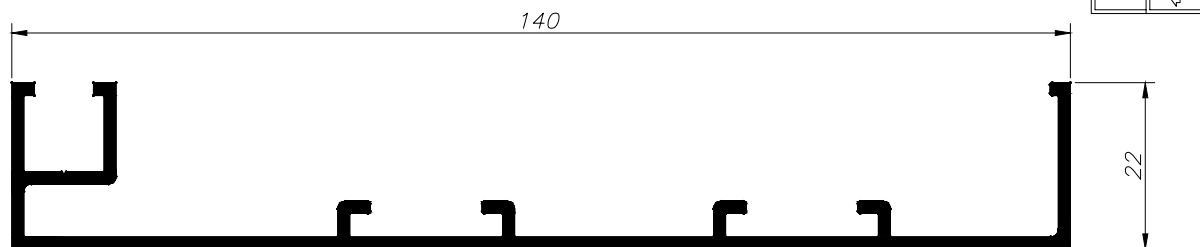

EMN-003
1,030 kg/m

TRILHO 2 FOLHAS / CORRER

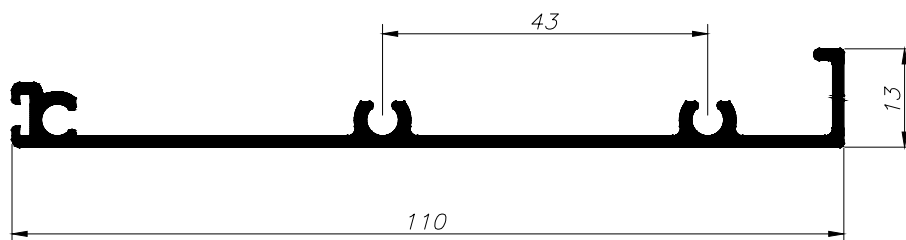

EMN-002
0,669 kg/m

TAMPA EXTERNA PORTA / CORRER

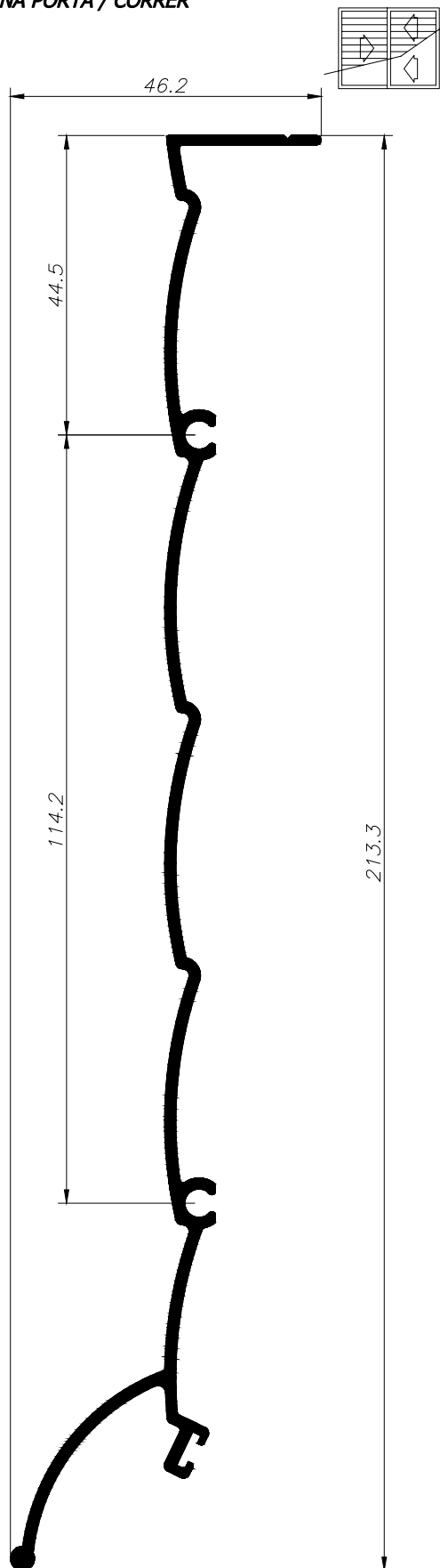

EMN-039
1,333 kg/m

TAMPA INTERNA JANELA / CORRER

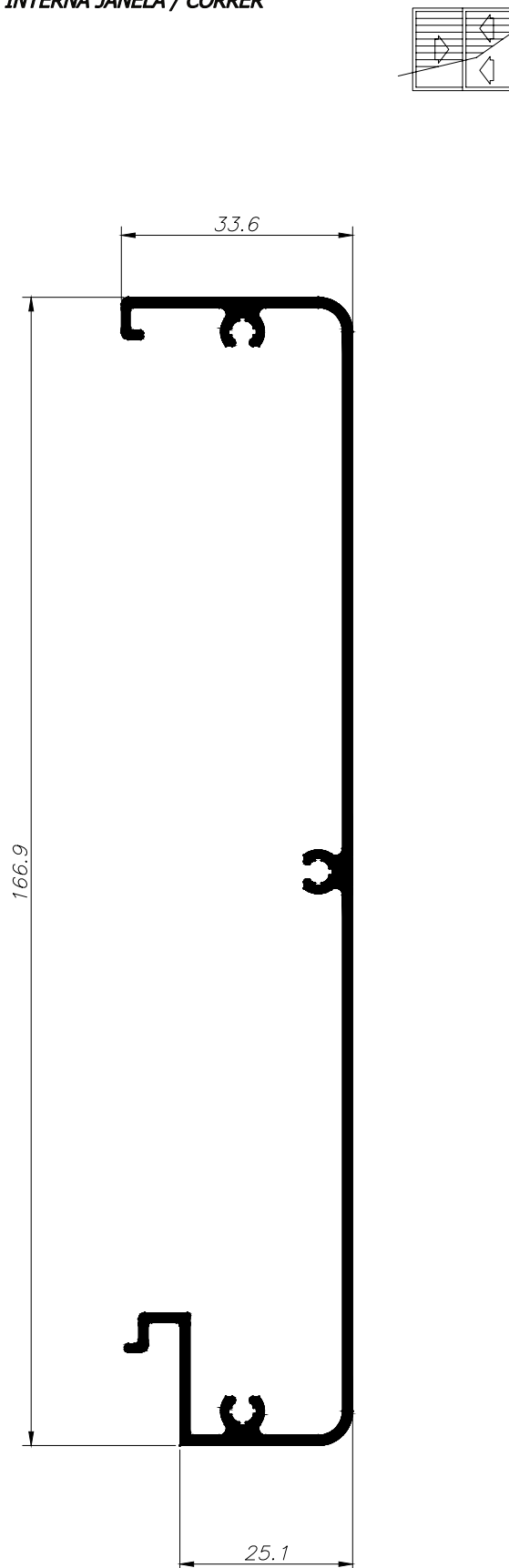

EMN-031
1,198 kg/m

TRILHO 2 FOLHAS / CORRER

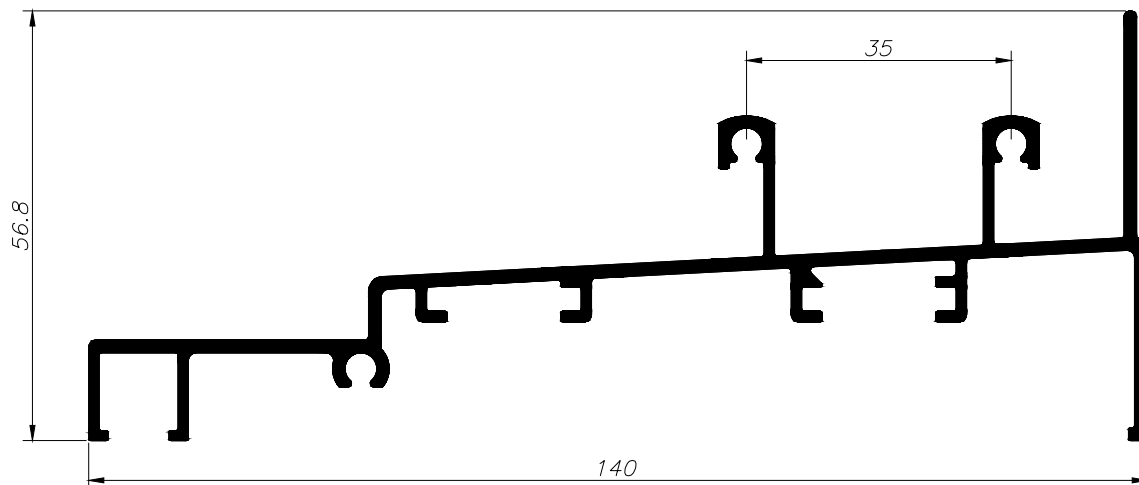
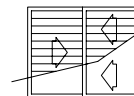

EMN-010
1,496 kg/m

TAMPA INTERNA JANELA / CORRER

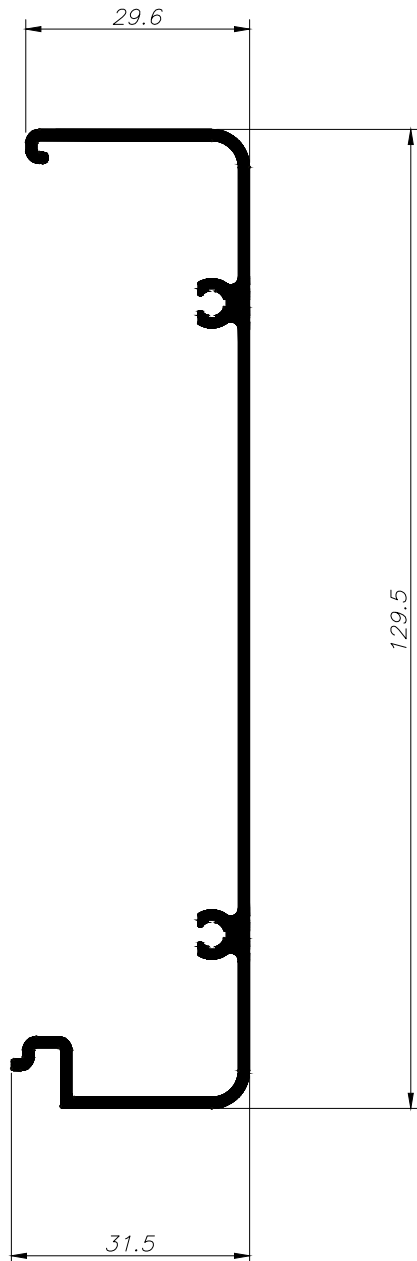
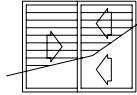

EMN-608
0,814 kg/m

TAMPA INTERNA INFERIOR

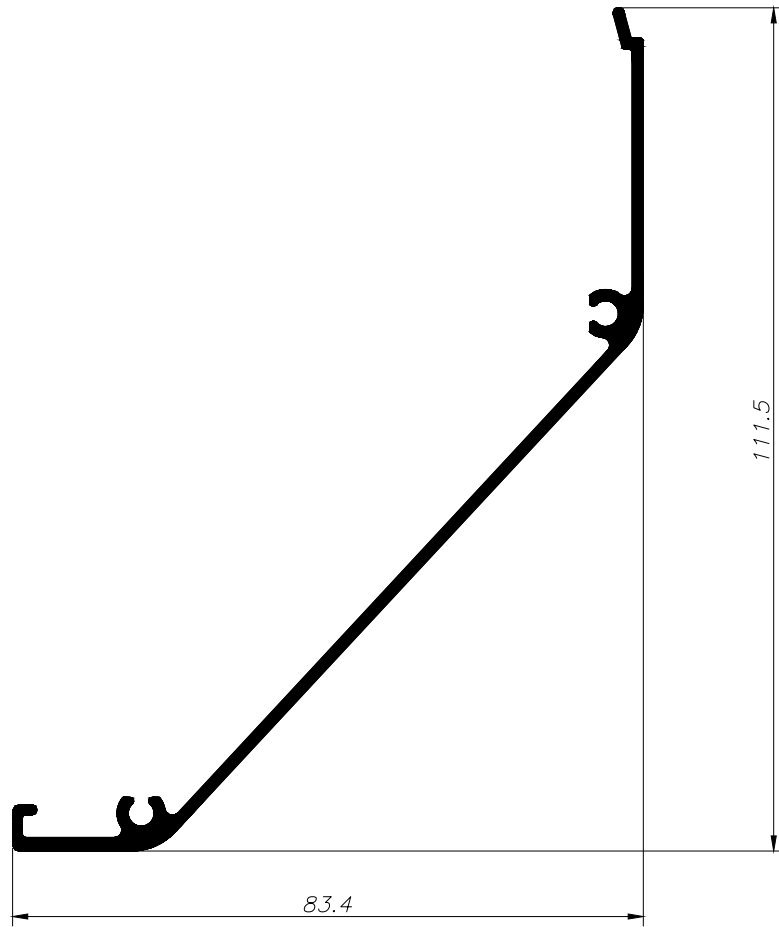

EMN-005
0,890 kg/m

TAMPA INTERNA SUPERIOR

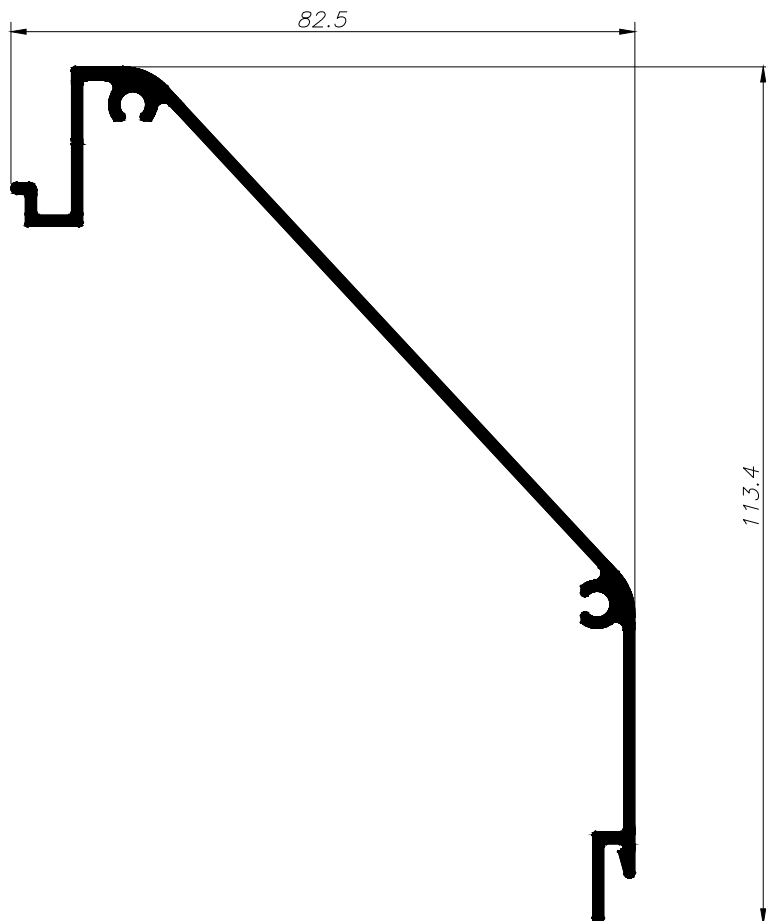

EMN-006
0,890 kg/m

TAMPA INTERNA PORTA 25 E 30 / CORRER

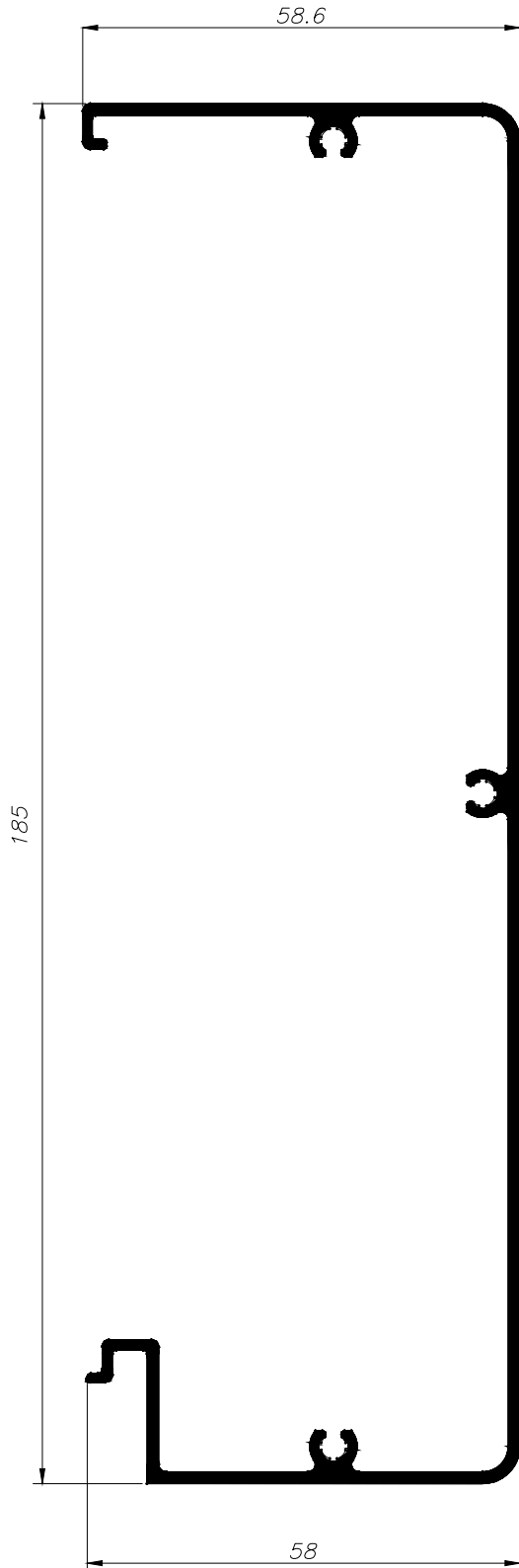
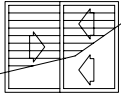

EMN-032
1,550 kg/m

TAMPA EXTERNA JANELA / CORRER

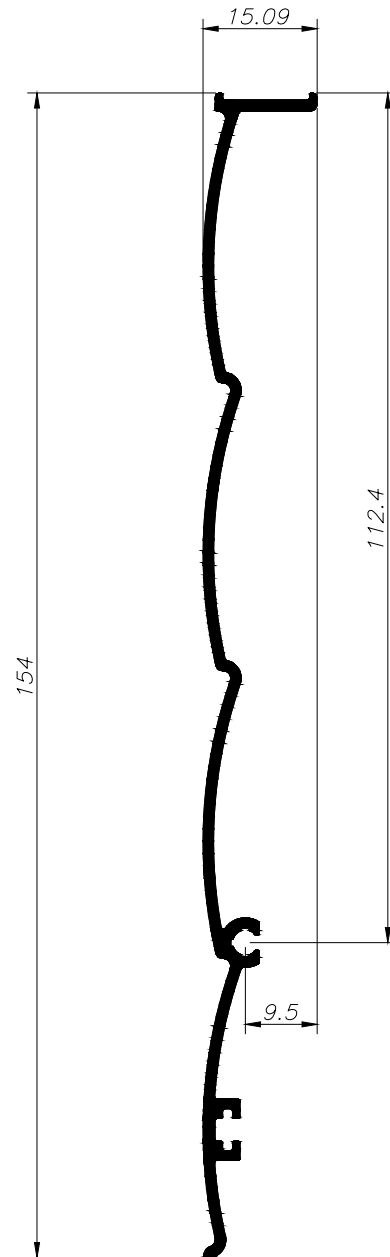
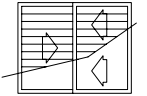

EMN-008
0,737 kg/m

GUIA ESTEIRA COM CAIXA / CORRER

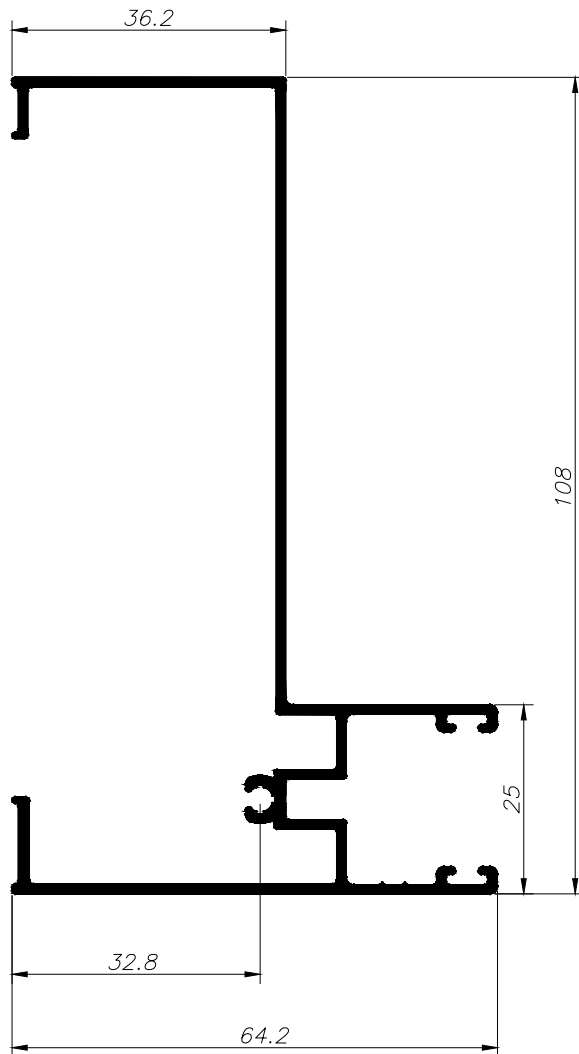
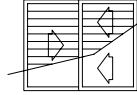

EMN-500
1,020 kg/m

GUIA ESTEIRA / CORRER

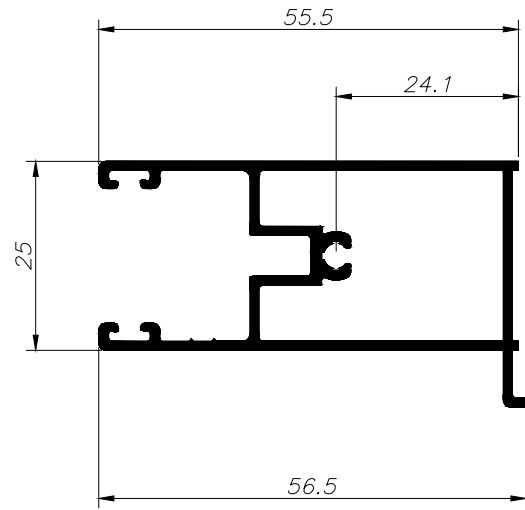
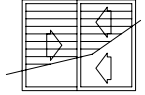

EMN-007
0,676 kg/m

TUBO OCTAGONAL / CORRER

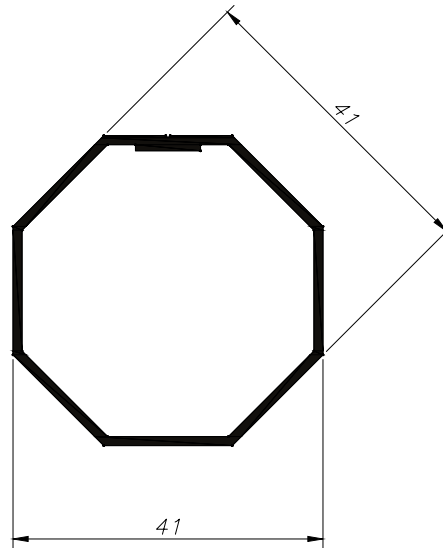
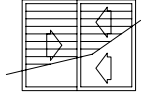

EMN-178
0,447 kg/m

TUBO OCTAGONAL / CORRER

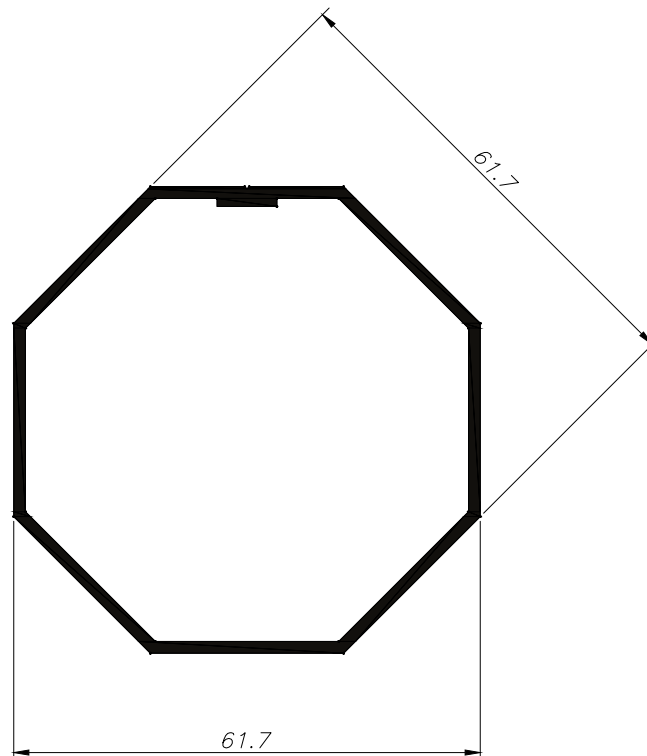
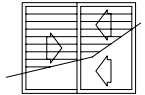

EMN-015
0,859 kg/m

PERFIL SOLEIRA/ CORRER

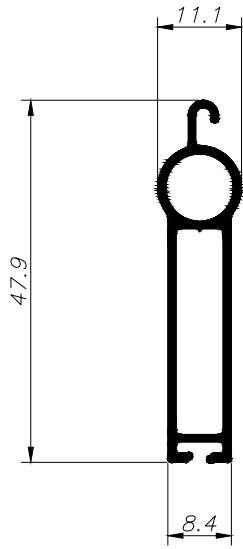

EMN-055
0,342 kg/m

REMATE/ CORRER

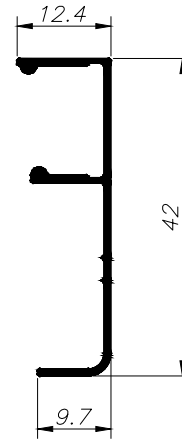

EMN-014
0,190 kg/m

CAIXA FITA / CORRER

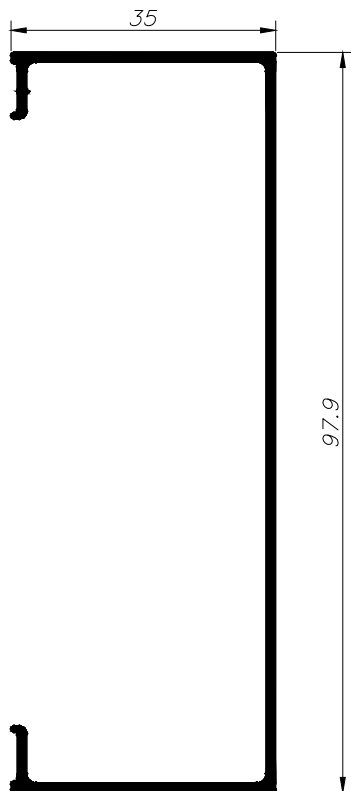

EMN-050
0,641 kg/m

COMPLEMENTO/ CORRER

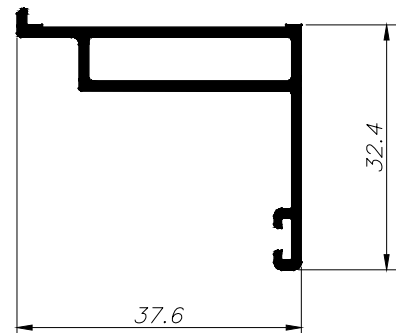

EMN-019
0,393 kg/m

MONTANTE LATERAL 2 PLANOS / CORRER

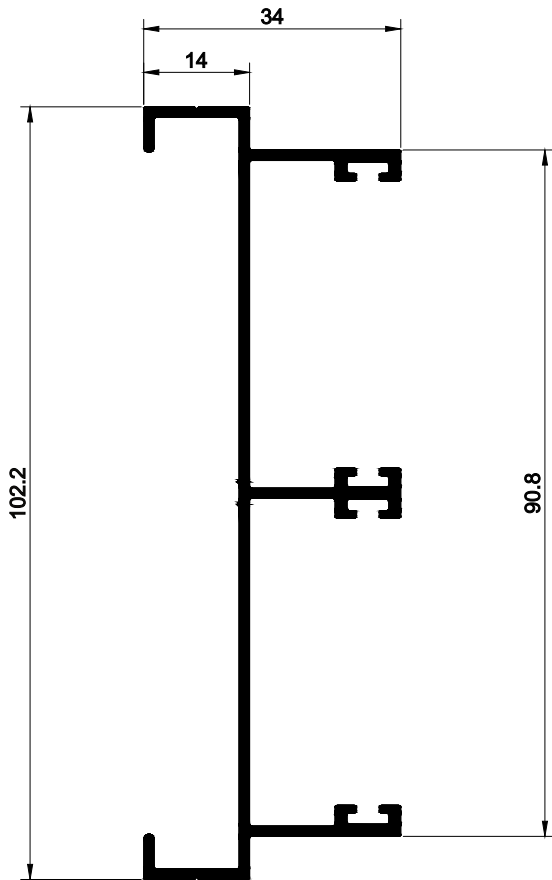
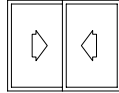

ELG-045
0,873 kg/m

MONTANTE LATERAL 2 PLANOS LISO / CORRER

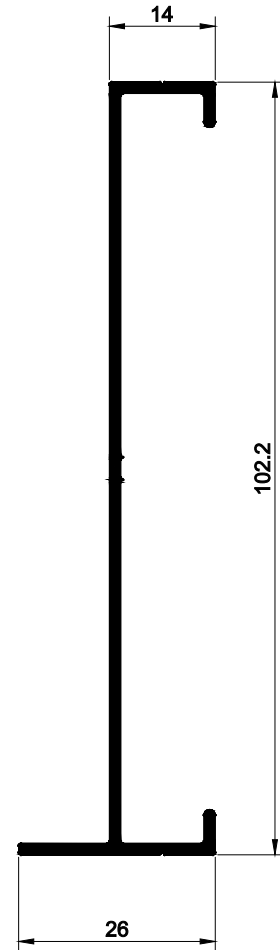
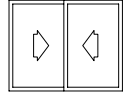

ELG-002
0,602 kg/m

MARCO INFERIOR E SUPERIOR BANDEIRA E PEITORIL / CORRER

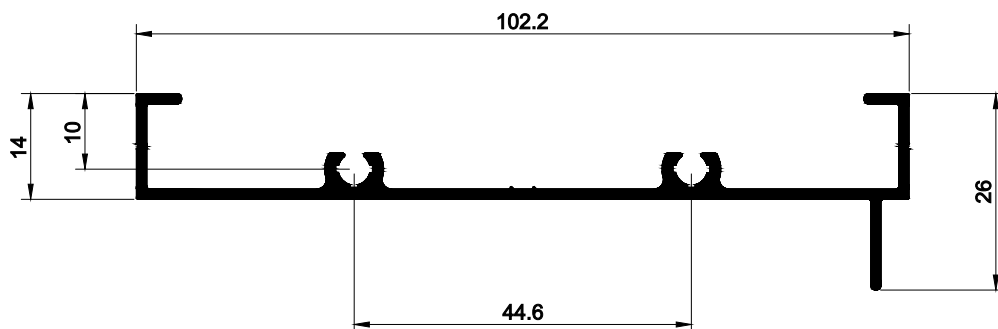
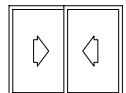

ELG-003
0,675 kg/m

TRILHO SUPERIOR 2 PLANOS / CORRER

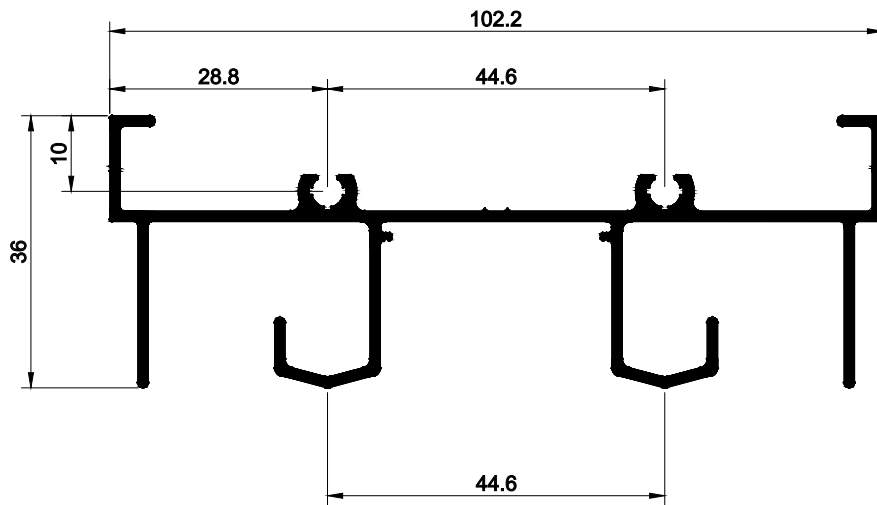

ELG-044
1,106 kg/m

TRILHO INFERIOR 2 PLANOS / CORRER

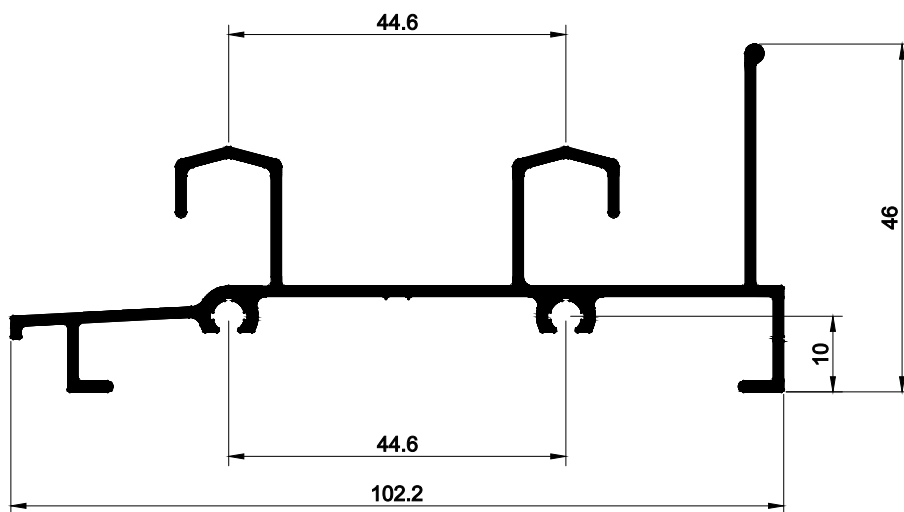

ELG-047
1,014 kg/m

TRILHO BANDEIRA 2 PLANOS / CORRER

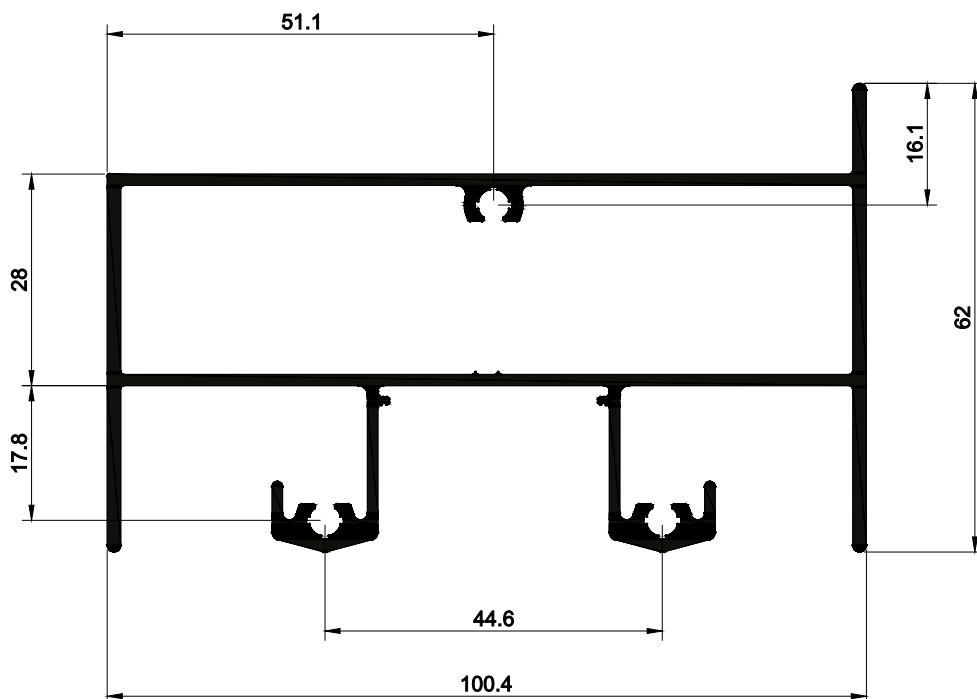
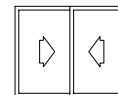

ELG-004
1,826 kg/m

MONTANTE PEITORIL 2 PLANOS / CORRER

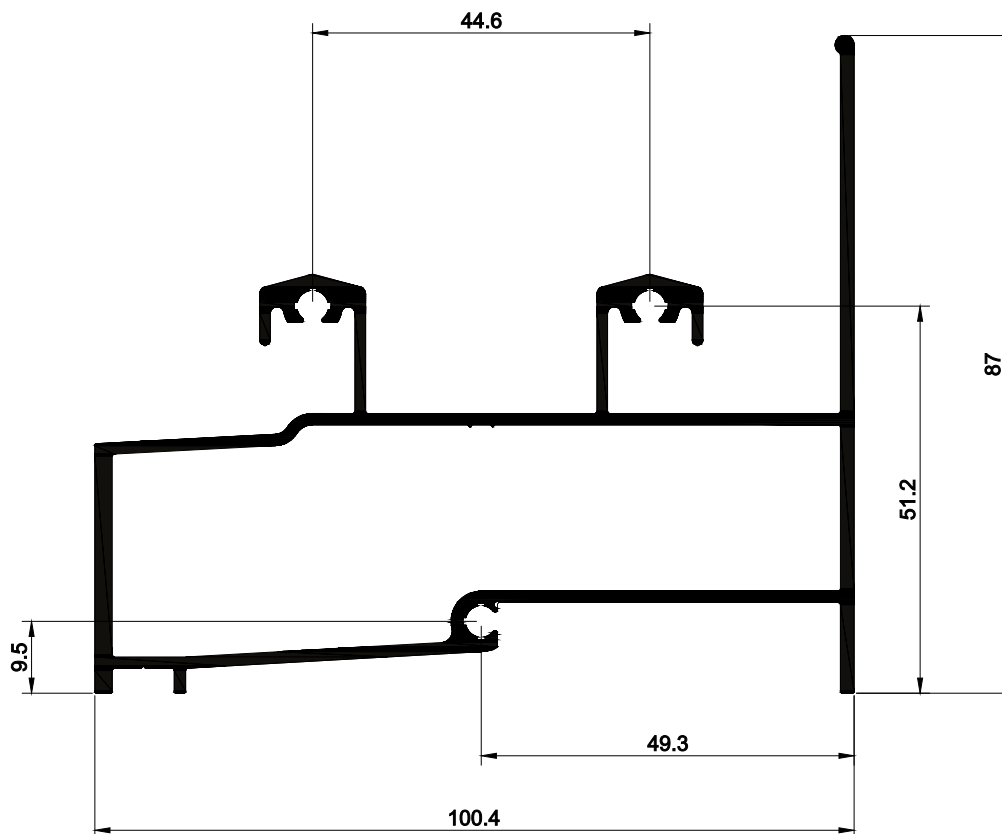
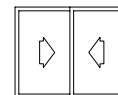

ELG-005
1,891 kg/m

MONT. LAT. 4 PLANOS / CORRER

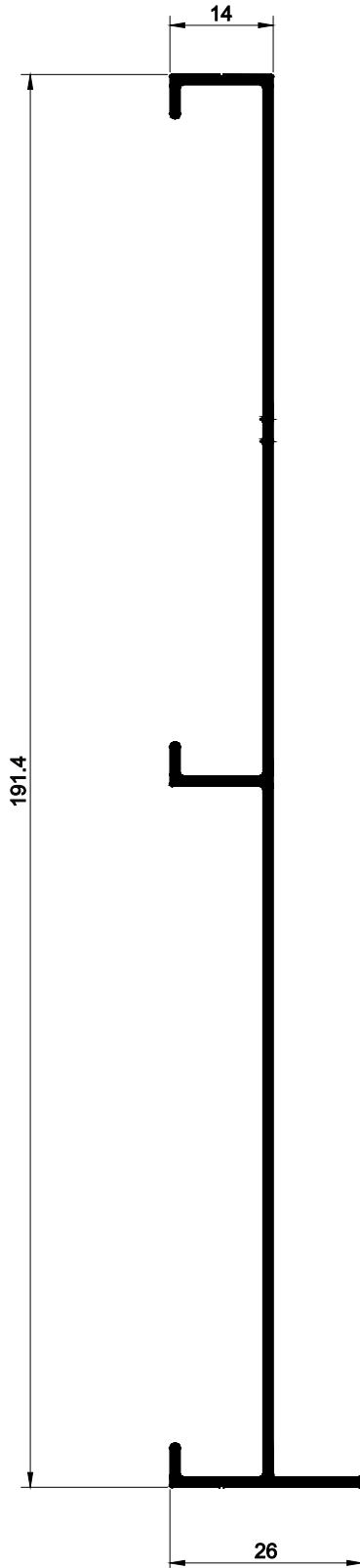
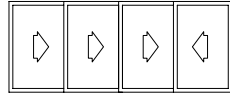

ELG-072
0,965 kg/m

MATA JUNTA POSTIÇO / CORRER

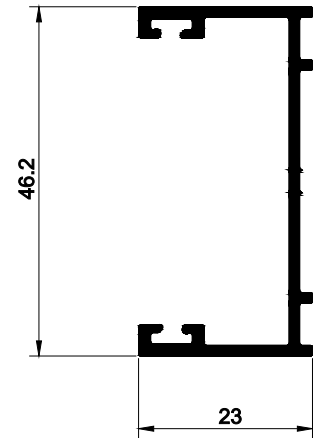
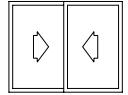

ELG-028
0,419 kg/m

PISTA POSTIÇO / CORRER

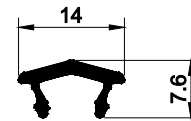
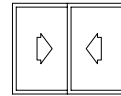

ELG-111
0,092 kg/m

TRILHO POSTIÇO / CORRER

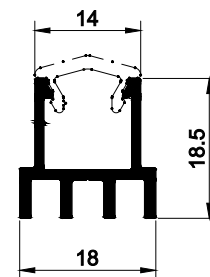
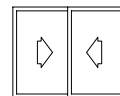

ELG-157
0,238 kg/m

MONTANTE LATERAL 3 PLANOS / CORRER

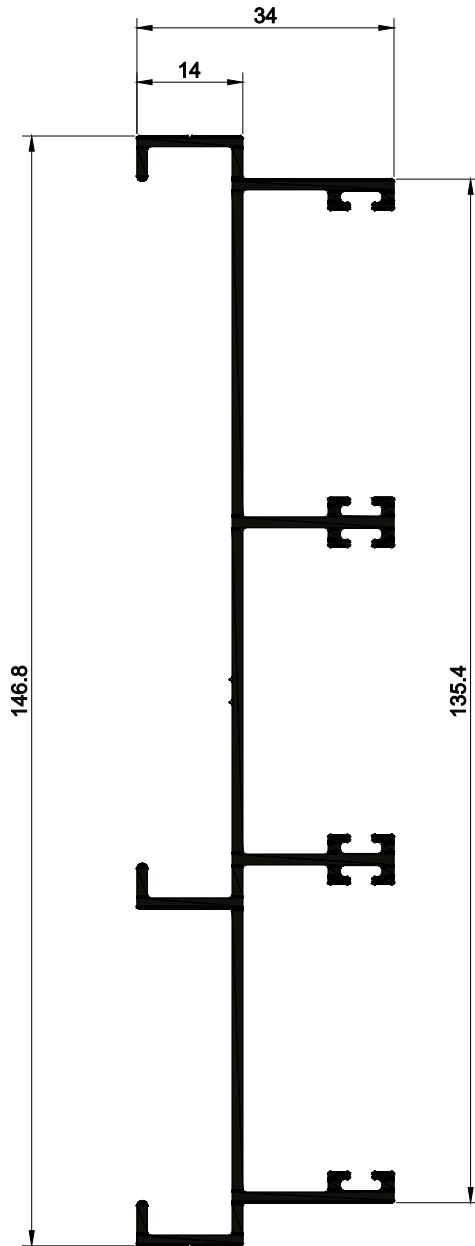
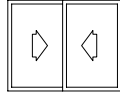

ELG-064
1,244 kg/m

MONTANTE LATERAL 3 PLANOS LISO / CORRER

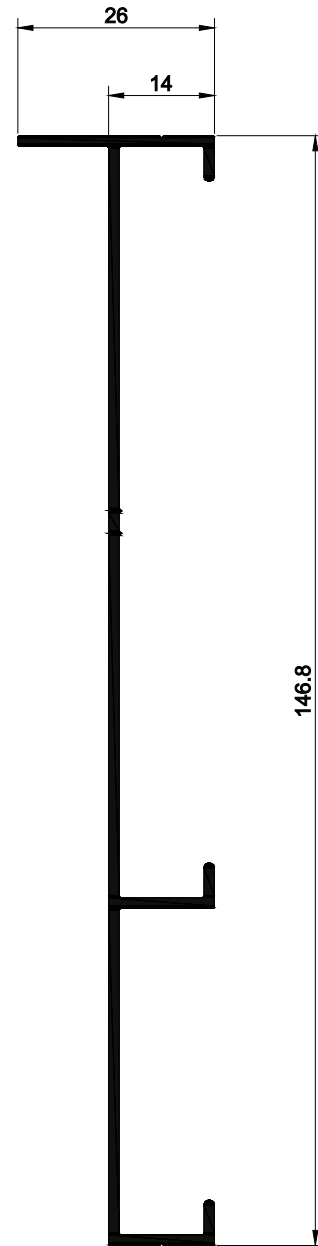
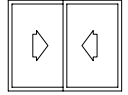

ELG-158
0,797 kg/m

TRILHO SUP. 4 PLANOS / CORRER

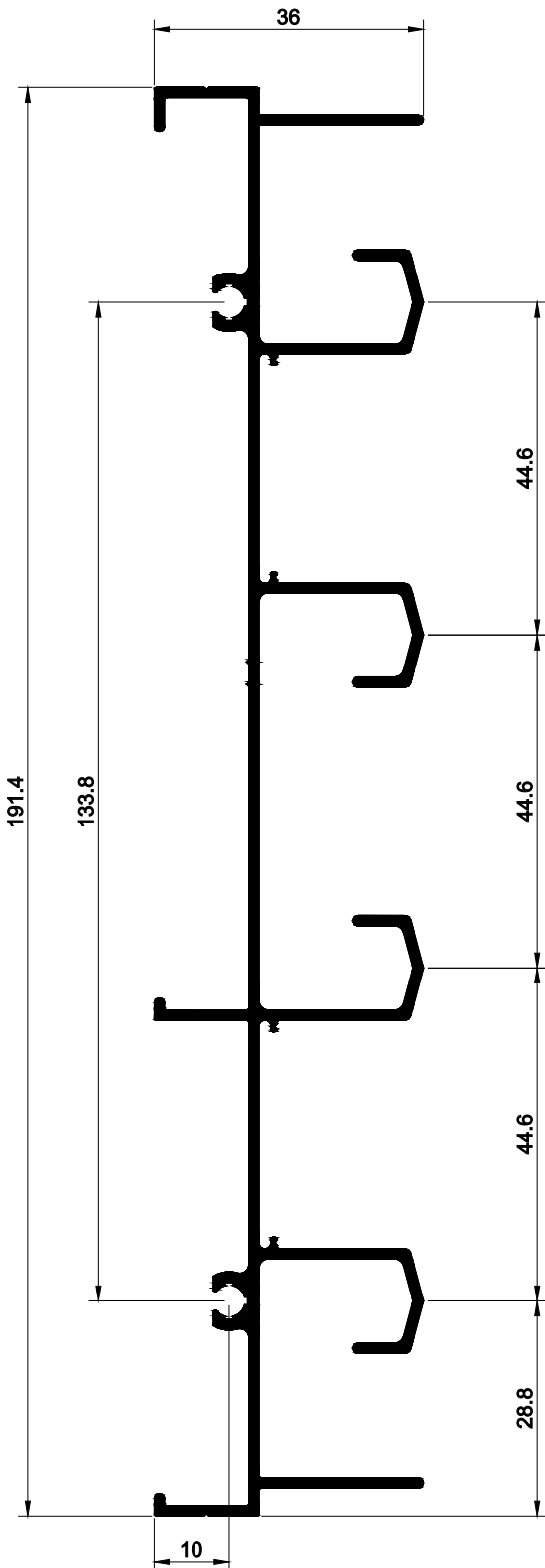
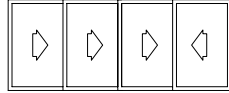

ELG-070
1,797 kg/m

TRILHO INF. 4 PLANOS / CORRER

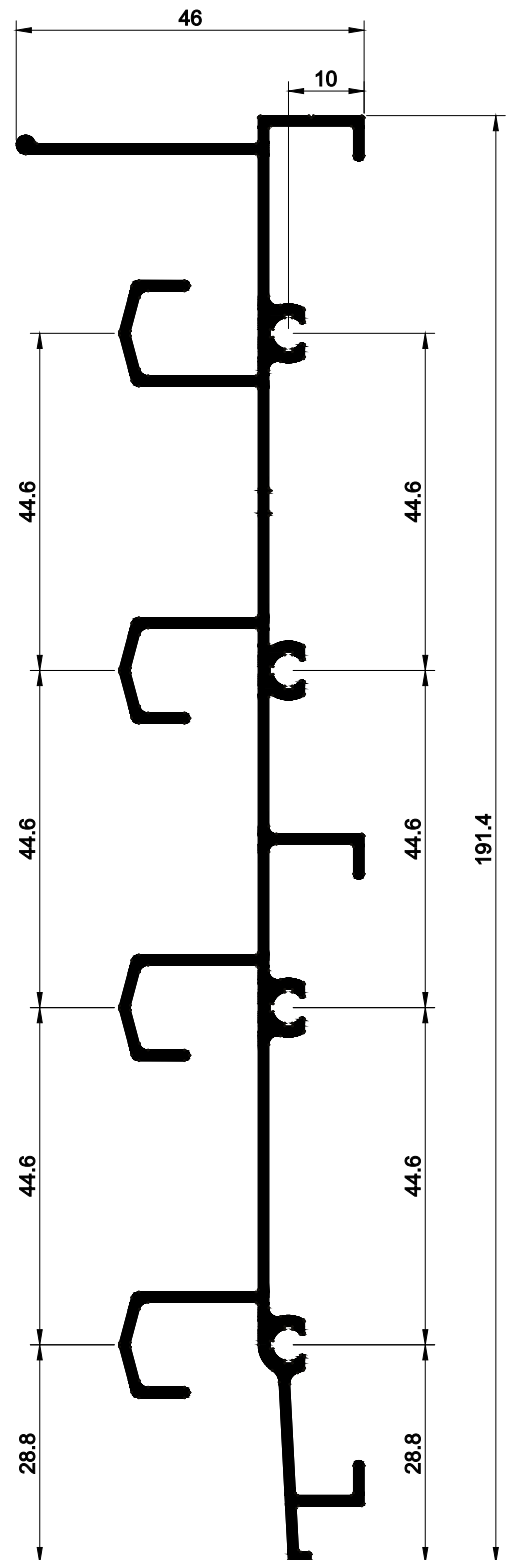
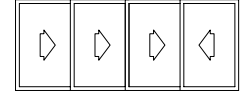

ELG-071
1,800 kg/m

TRILHO BANDEIRA 3 PLANOS / CORRER

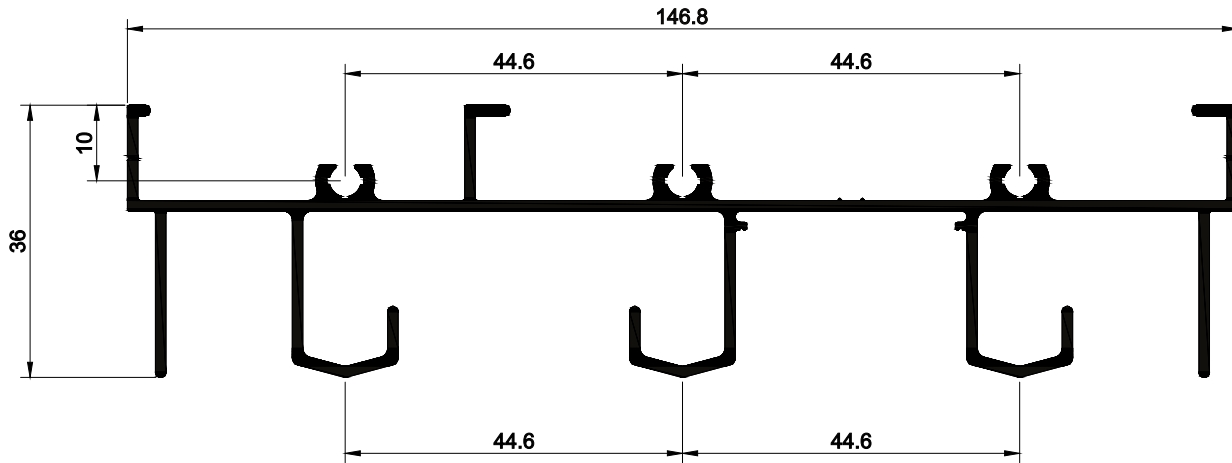
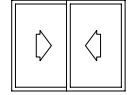

ELG-062
1,537kg/m

MONTANTE PEITORIL 3 PLANOS / CORRER

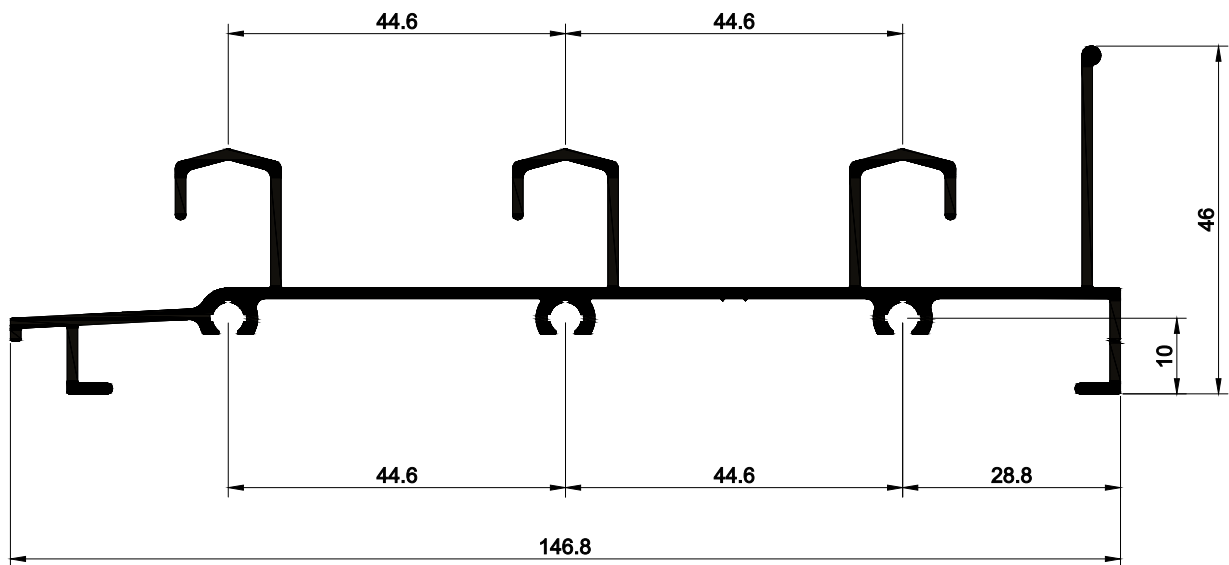
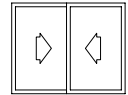

ELG-066
1,372kg/m

TRAVESSA INFERIOR - SUPERIOR / CORRER

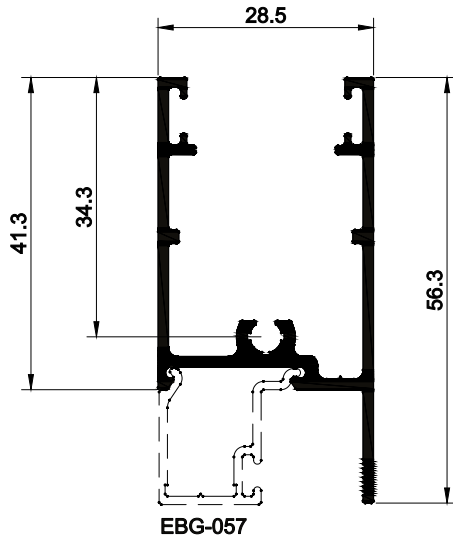

ELG-006
0,613 kg/m

TRAVESSA CENTRAL / CORRER

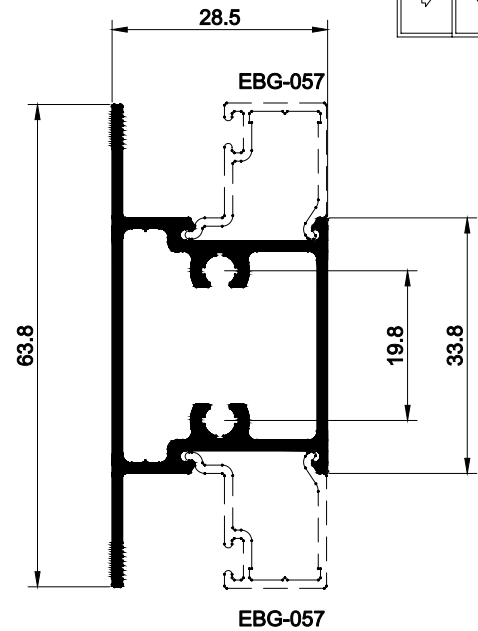

ELG-055
0,718 kg/m

TRAVESSA INFERIOR / CORRER

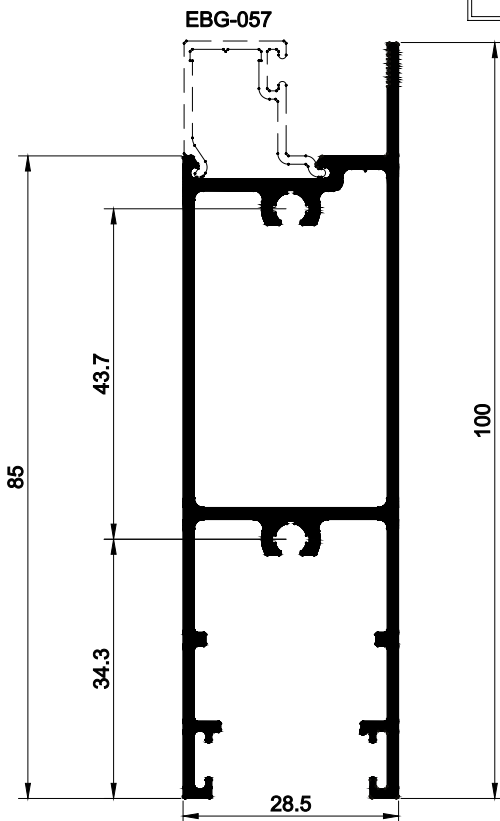

ELG-007
1,176 kg/m

INVERSOR BAGUETE

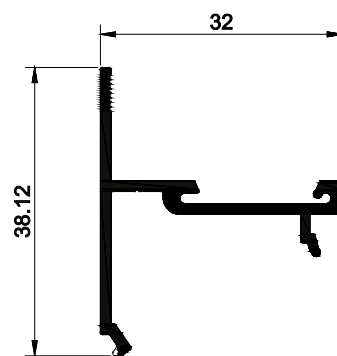

ELG-077
0,329 kg/m

MONTANTE / CORRER

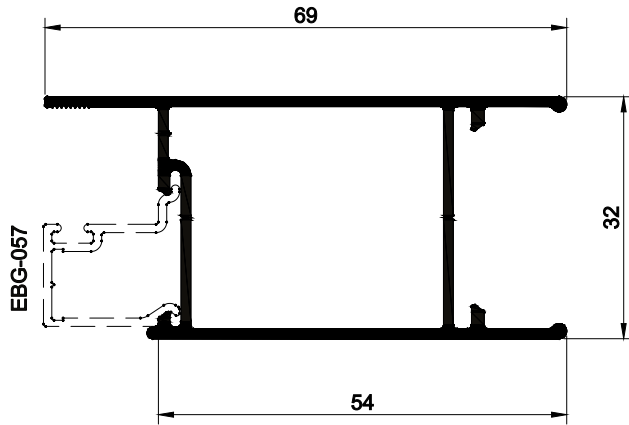
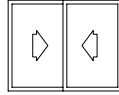

ELG-050
0,710 kg/m

MONTANTE CENTRAL / CORRER

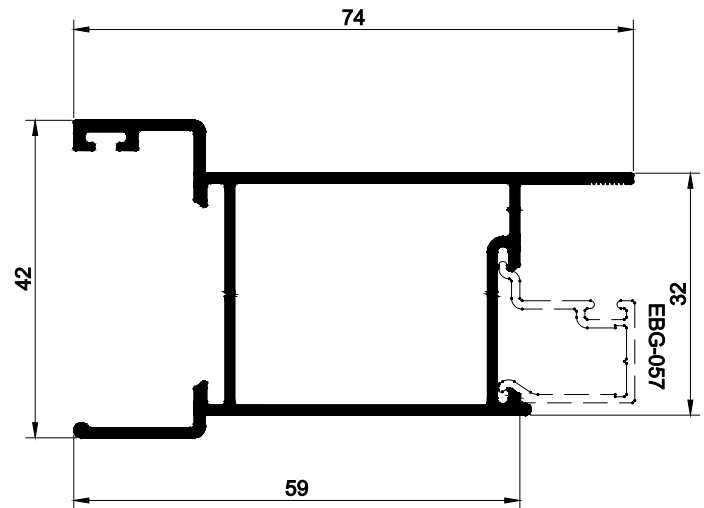
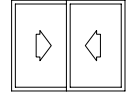

ELG-051
0,812 kg/m

MÃO DE AMIGO / CORRER

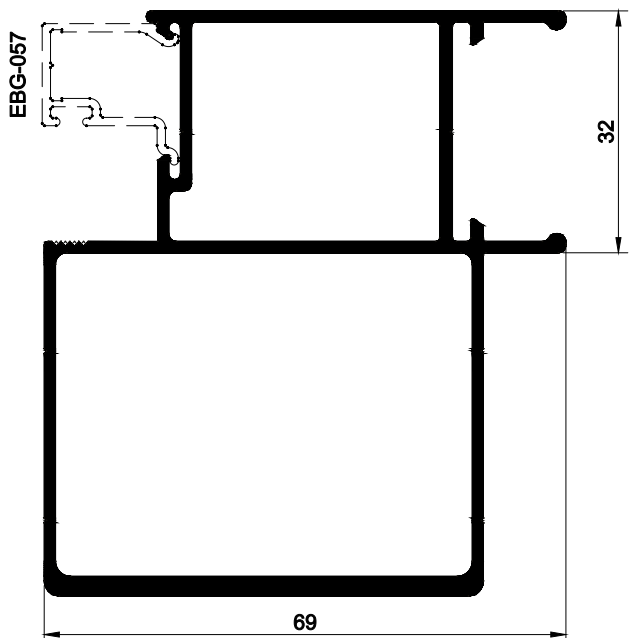
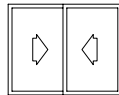

ELG-054
1,581 kg/m

MÃO DE AMIGO / CORRER

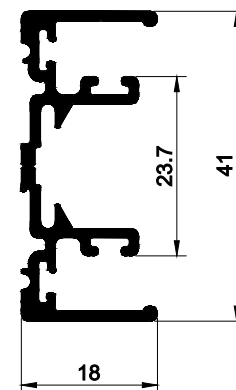
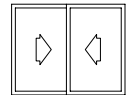

ELG-300
0,491 kg/m

MÃO DE AMIGO / CORRER

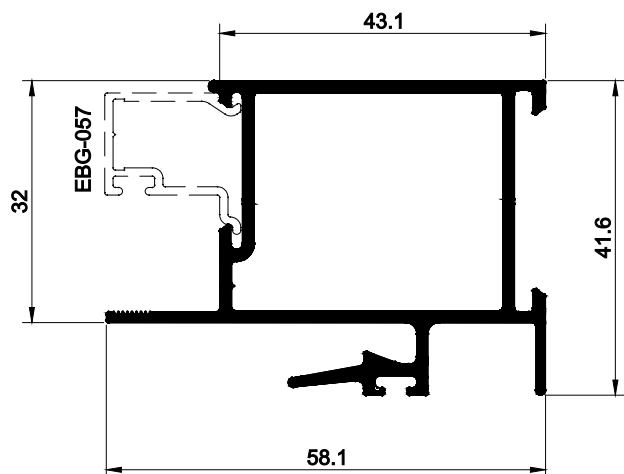
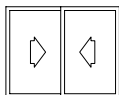

ELG-048
0,913 kg/m

MÃO DE AMIGO / CORRER

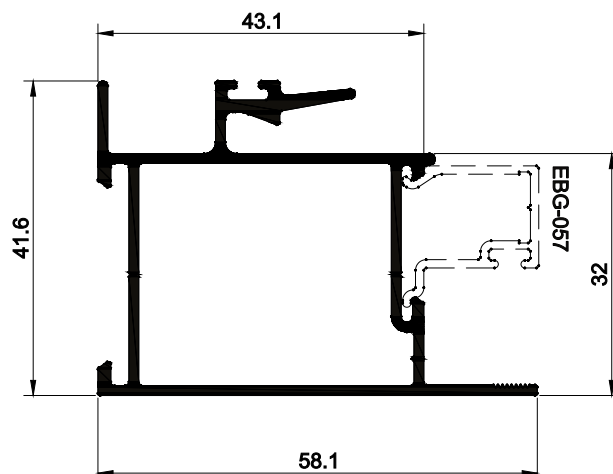
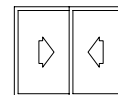

ELG-049
0,805 kg/m

MONTANTE / CORRER

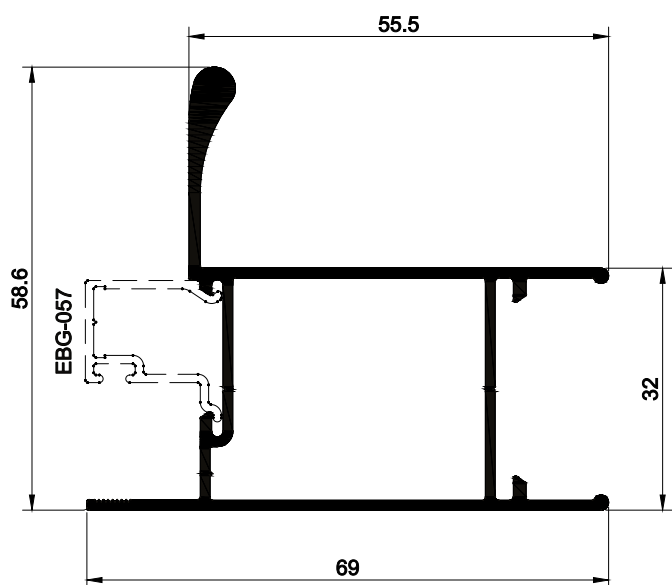
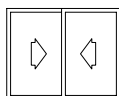

ELG-017
0,902 kg/m

MONTANTE CENTRAL / CORRER

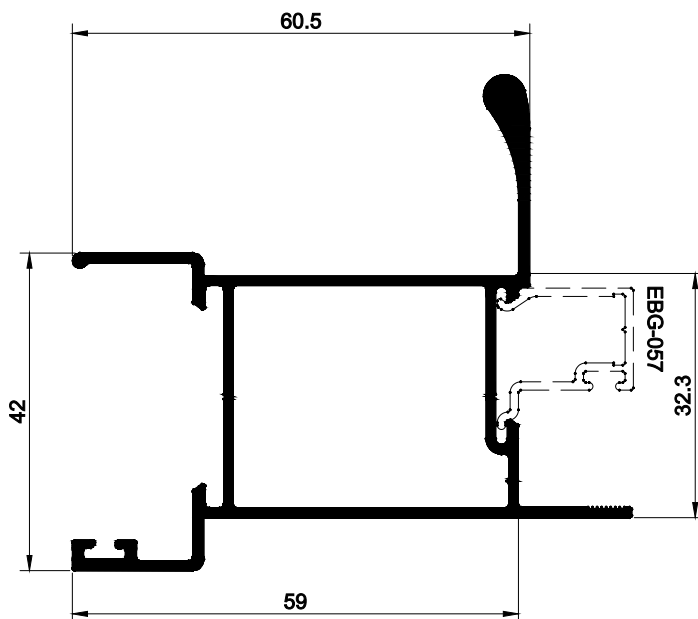
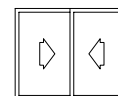

ELG-020
1,005 kg/m

PERFIL MARCO 45° / MAXIM-AR E GIRO

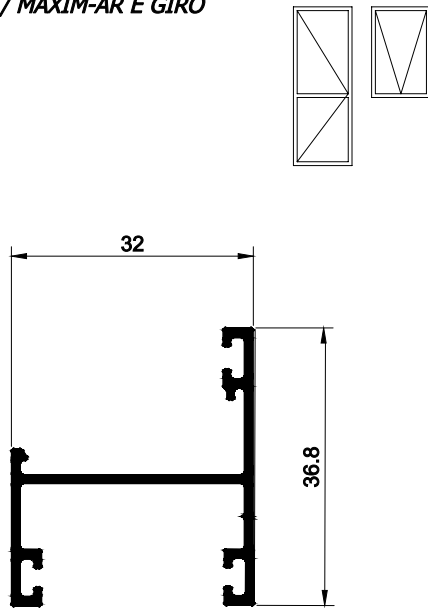

ELG-068
0,369 kg/m

PERFIL FOLHA / MAXIM-AR

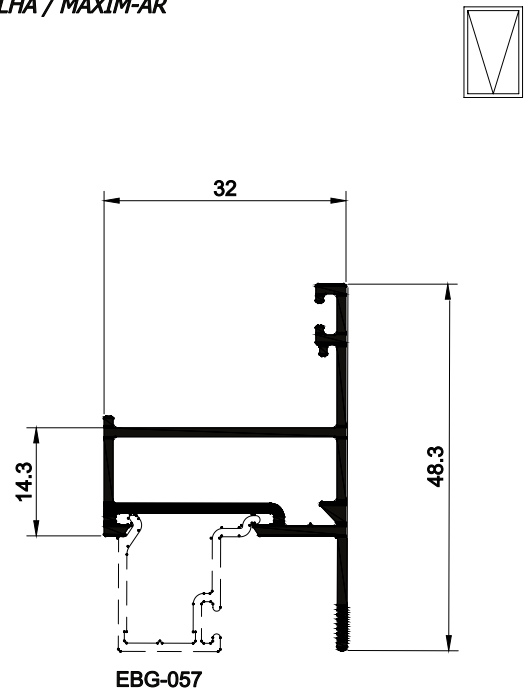

ELG-085
0,480 kg/m

TRAVESSA FOLHA / MAXIM-AR

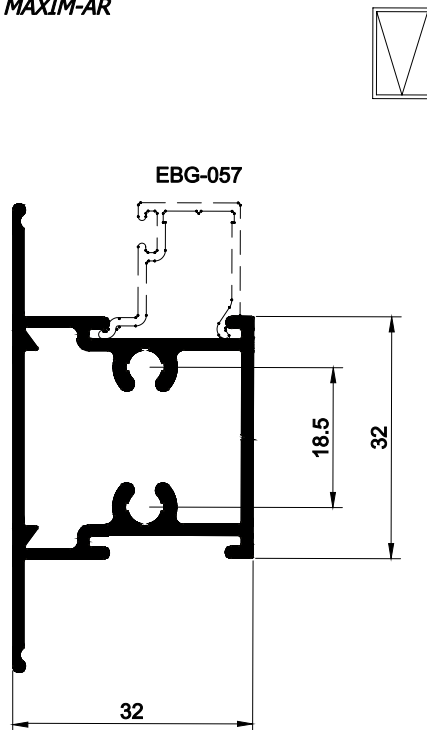

ELG-079
0,816 kg/m

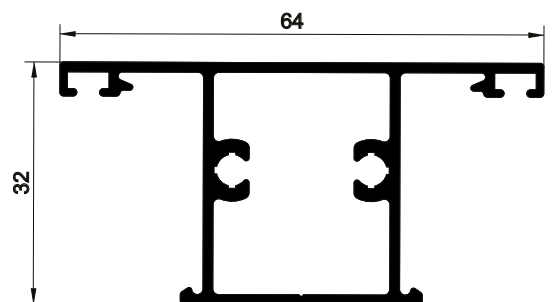

ELG-074
0,733 kg/m

MONTANTE / CORRER

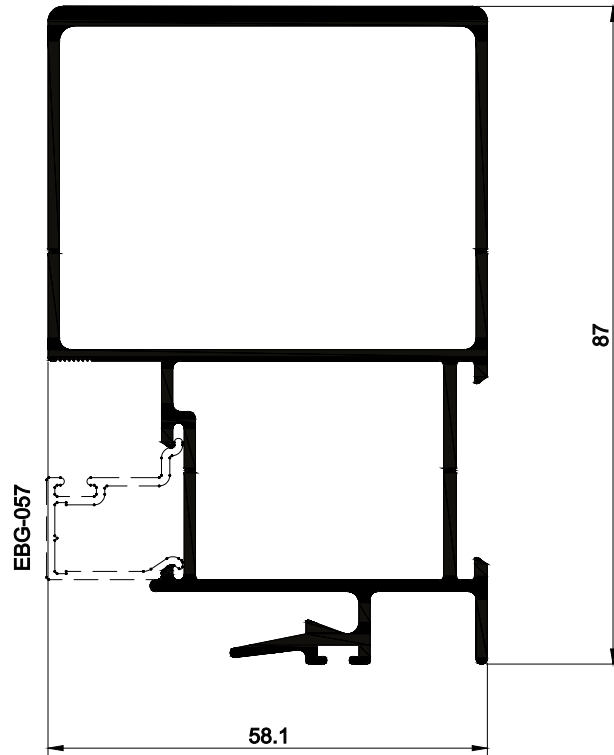
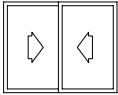

ELG-052
1,666 kg/m

MÃO DE AMIGO / CORRER

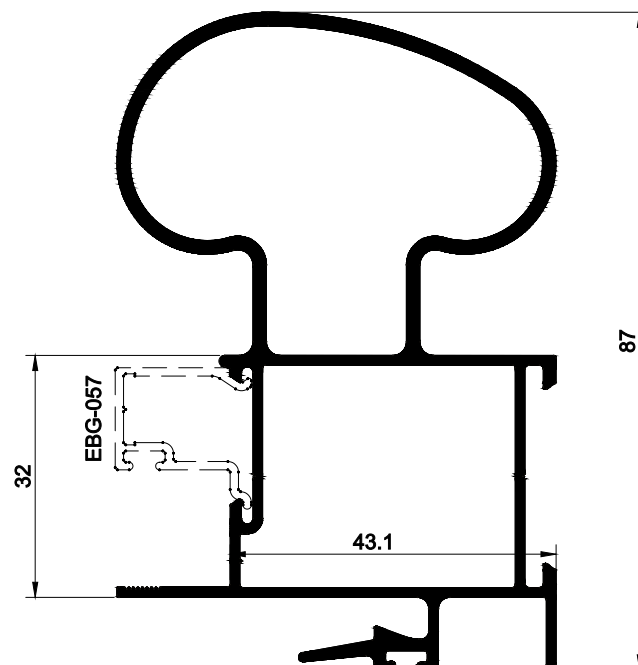
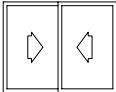

ELG-021
1,734 kg/m

PERFIL FOLHA 45° / GIRO

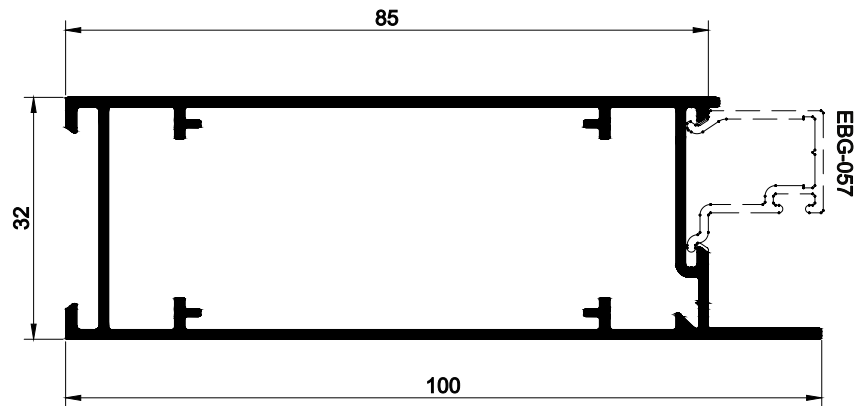

ELG-042
1,020 kg/m

PERFIL FOLHA 45° / GIRO

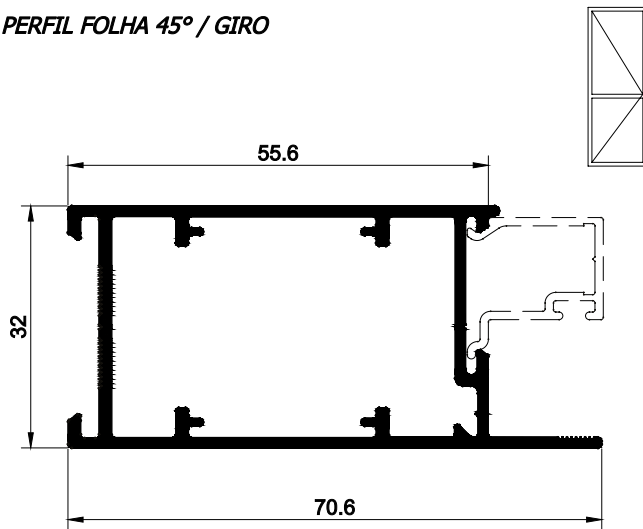

ELG-043
0,878 kg/m

TRAVESSA INFERIOR / GIRO

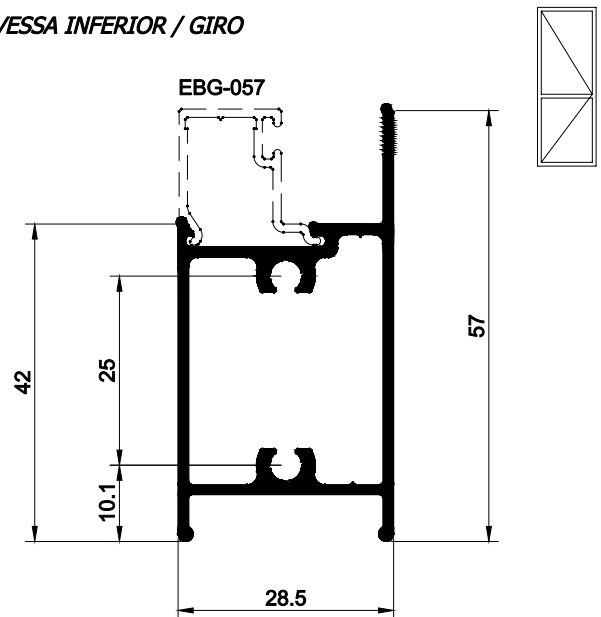

ELG-058
0,699 kg/m

BAGUETE

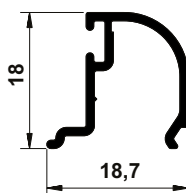

ELG-026
0,157 kg/m

BAGUETE

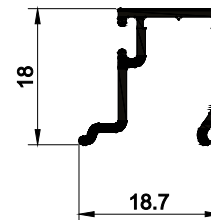

EBG-057
0,168 kg/m

COLUNA / MAXIM-AR

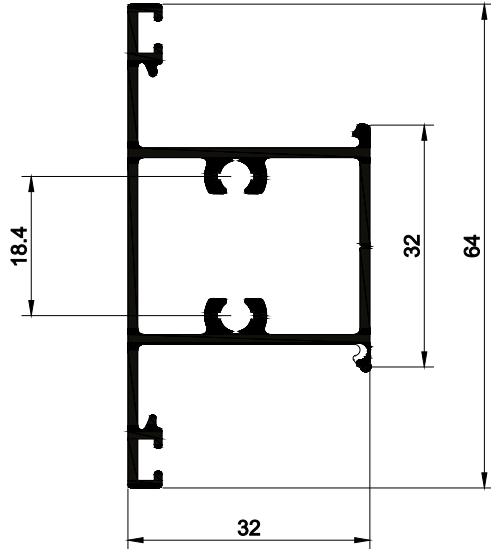
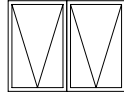

ELG-074
0,733 kg/m

PINGADEIRA / MAXIM-AR

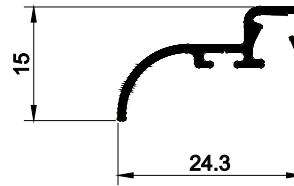

ELG-091
0,130 kg/m

PERFIL BANDEIRA-PEITORIL / MAXIM-AR

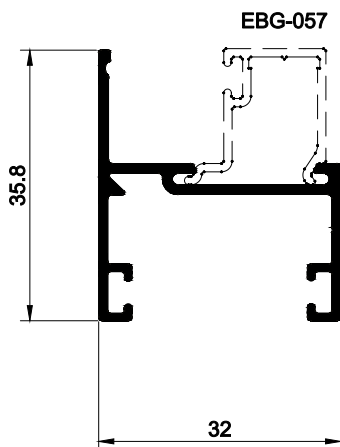
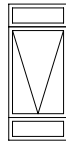

ELG-083
0,376 kg/m

MARCO / GIRO

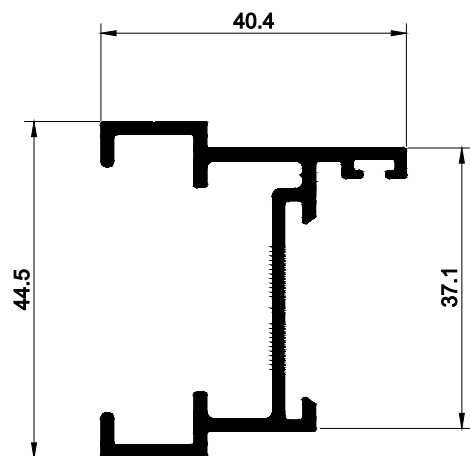
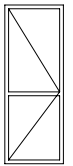

ELG-056
0,626 kg/m

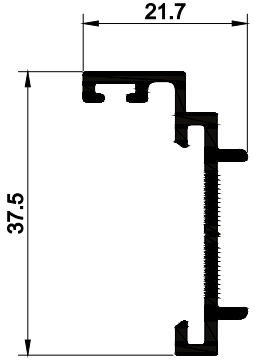
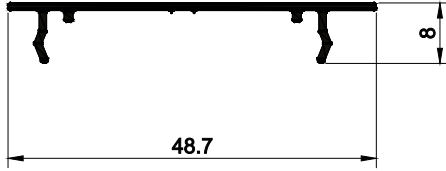
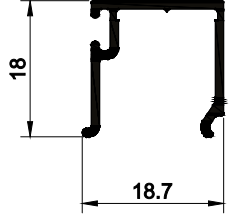
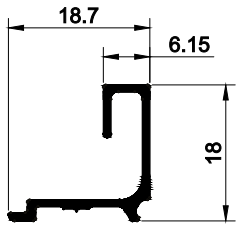
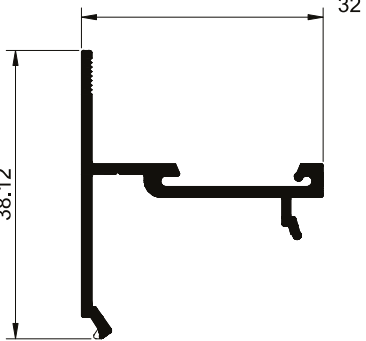
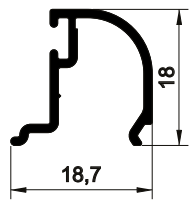
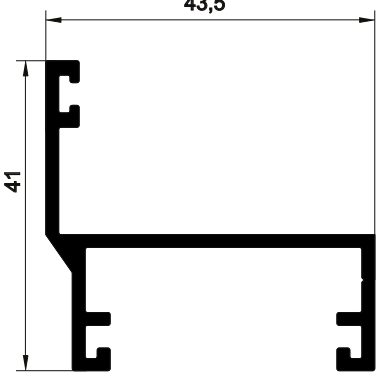
<p>POSTIÇO MATA-JUNTA</p>  <p>ELG-016 0,311 kg/m</p>	<p>TAMPA</p>  <p>ELG-046 0,181 kg/m</p>	
<p>BAGUETE</p>  <p>ELG-059 0,170 kg/m</p>	<p>PORTA PALHETA</p>  <p>ELG-027 0,135 kg/m</p>	
<p>INVERSOR BAGUETE</p>  <p>ELG-077 0,329 kg/m</p>	 <p>ELG-026 0,159 kg/m</p>	 <p>E42-042 0,570 kg/m</p>

COMPLEMENTO

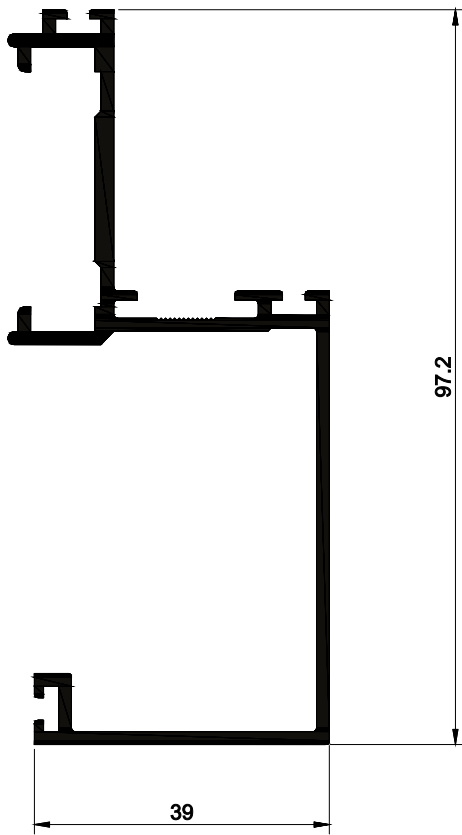

EFC-243
1,097 kg/m

COLUNA

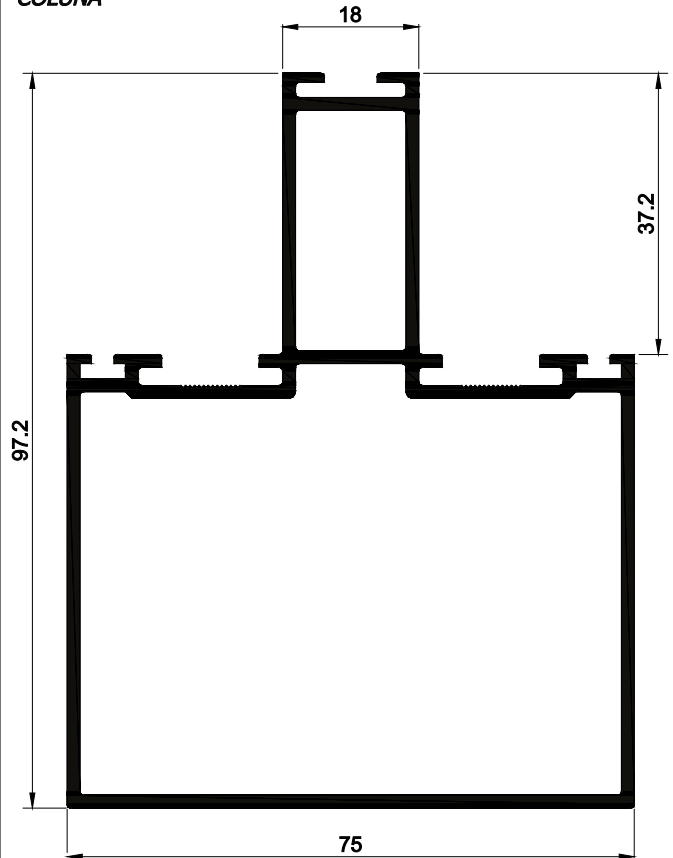

EFC-202
1,791 kg/m

COLUNA

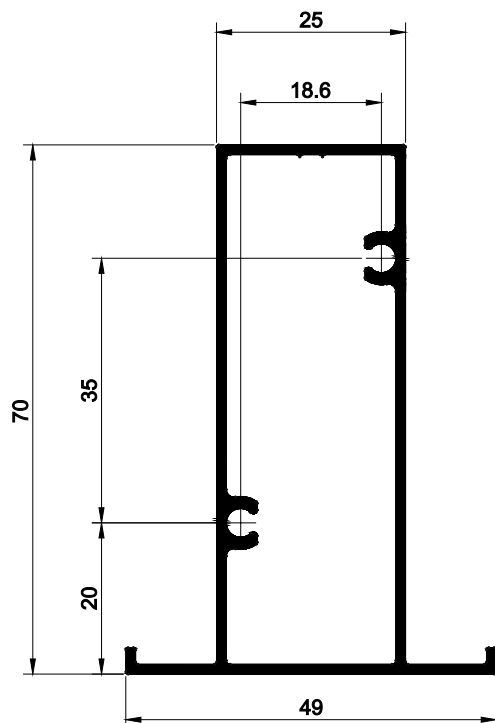

ELG-070
0,835 kg/m

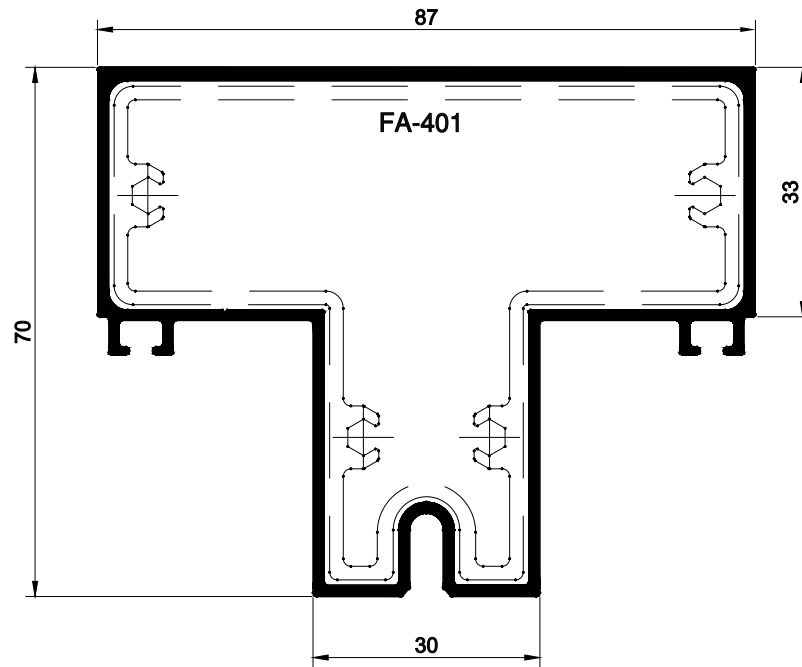

EFA-400
1,473 kg/m

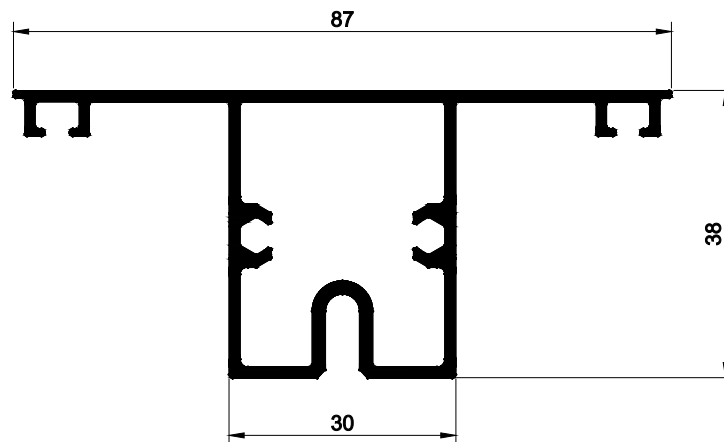

EFA-204
1,010 kg/m

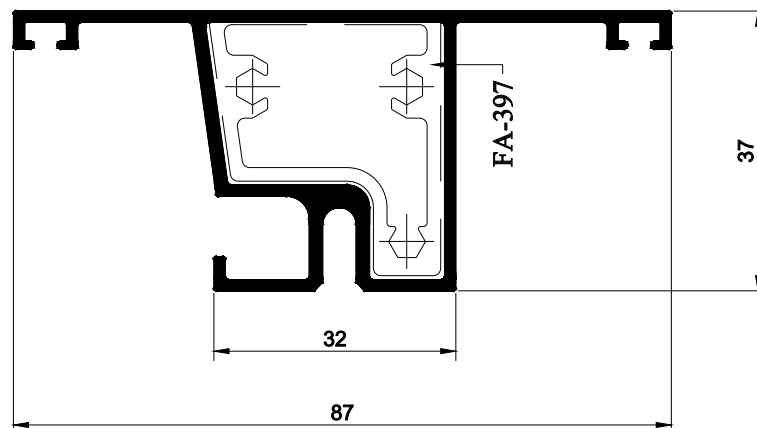

EFA-211
0,993 kg/m

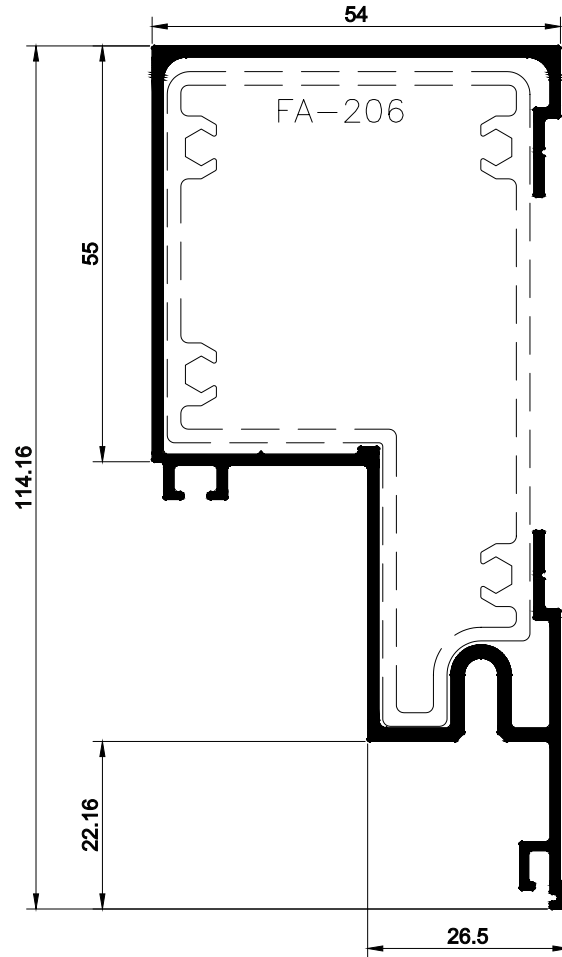

EFA-235
1,275 kg/m

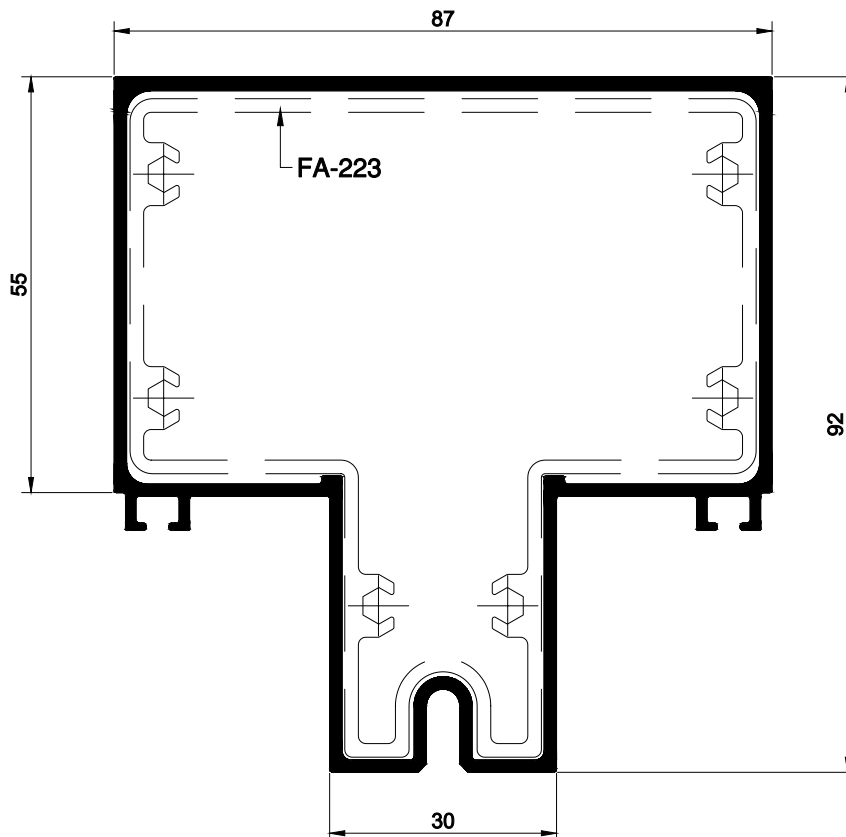

EFA-200
1,813 kg/m

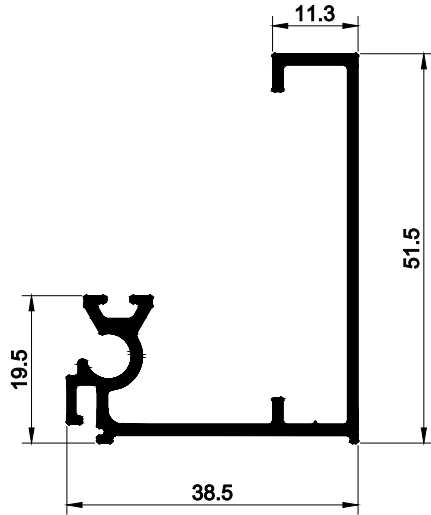

EFA-228
0,571 kg/m

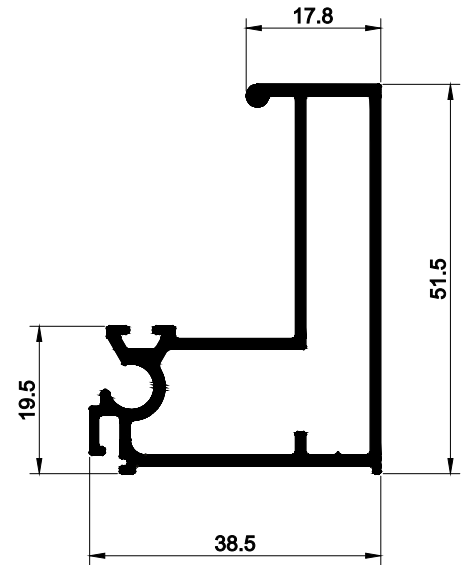

EFA-230
0,780 kg/m

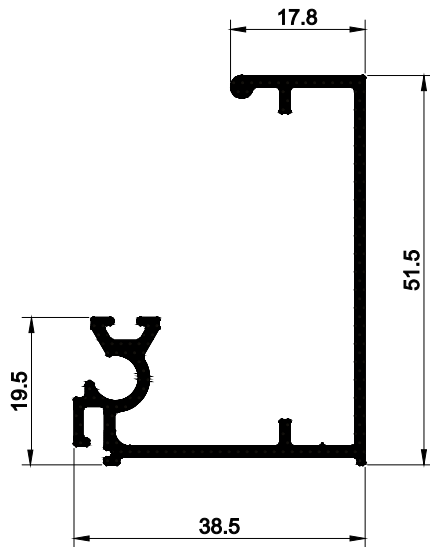

EFA-232
0,604 kg/m

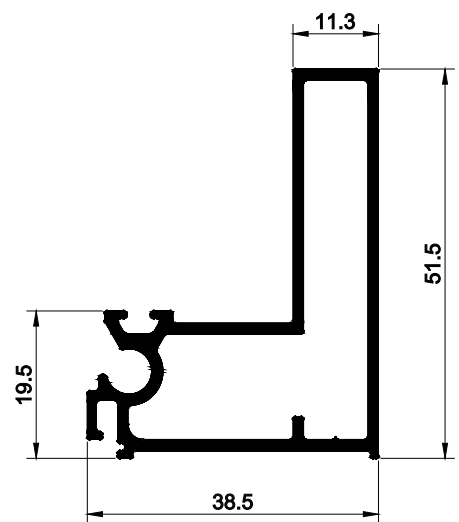

EFA-245
0,745 kg/m

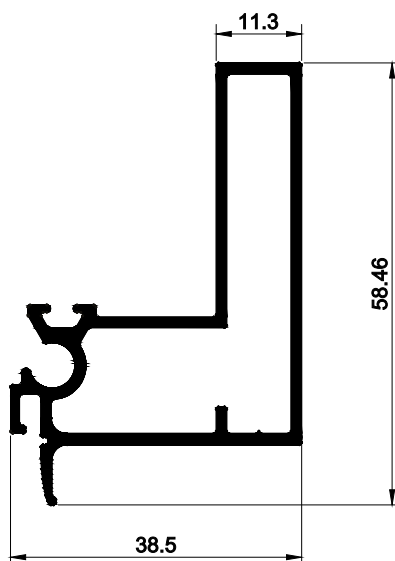

EFA-255
0,770 kg/m

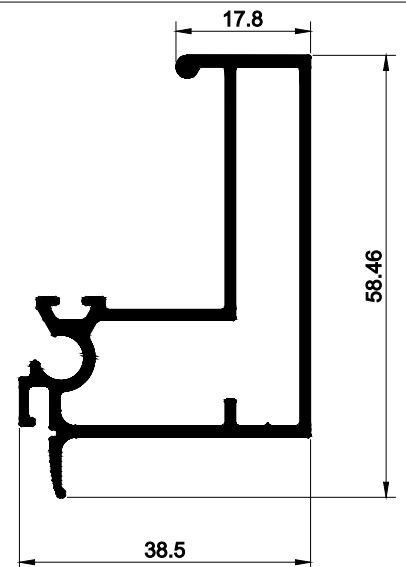

EFA-256
0,805 kg/m

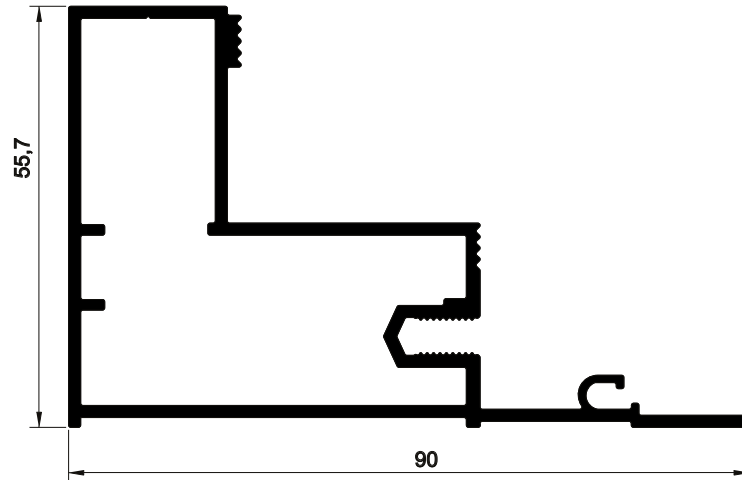

EFA-012
1,275 kg/m

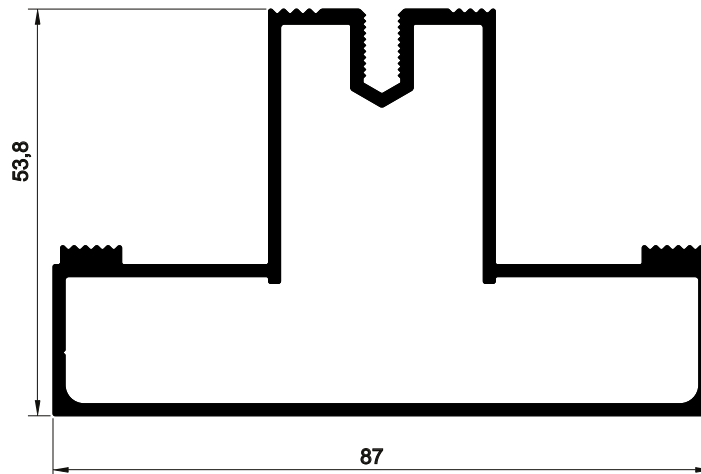

EFA-013
1,408 kg/m

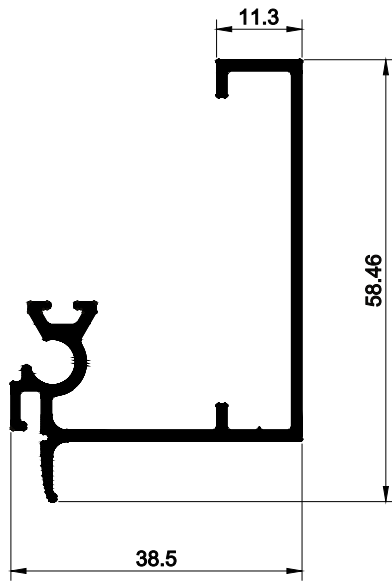

EFA-258
0,593 kg/m

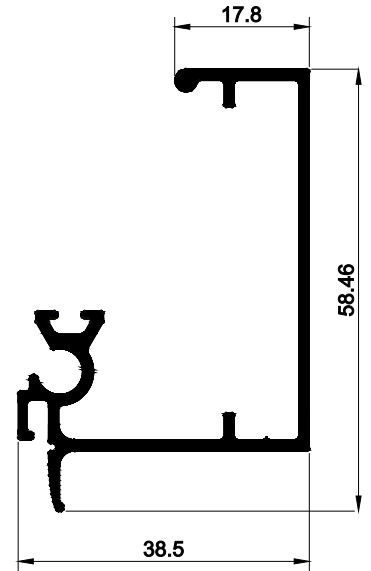

EFA-259
0,629 kg/m

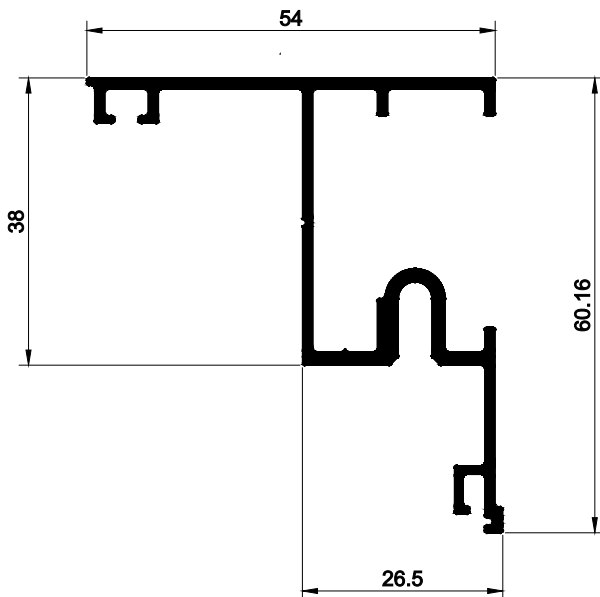

EFA-294
0,785 kg/m

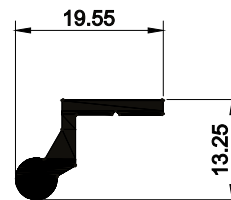

EFA-247
0,192 kg/m

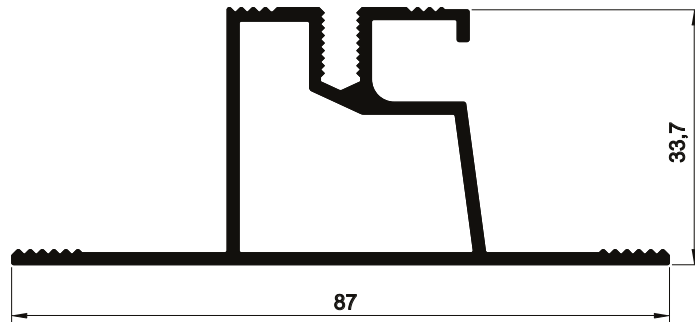

EFA-001
0,916 kg/m

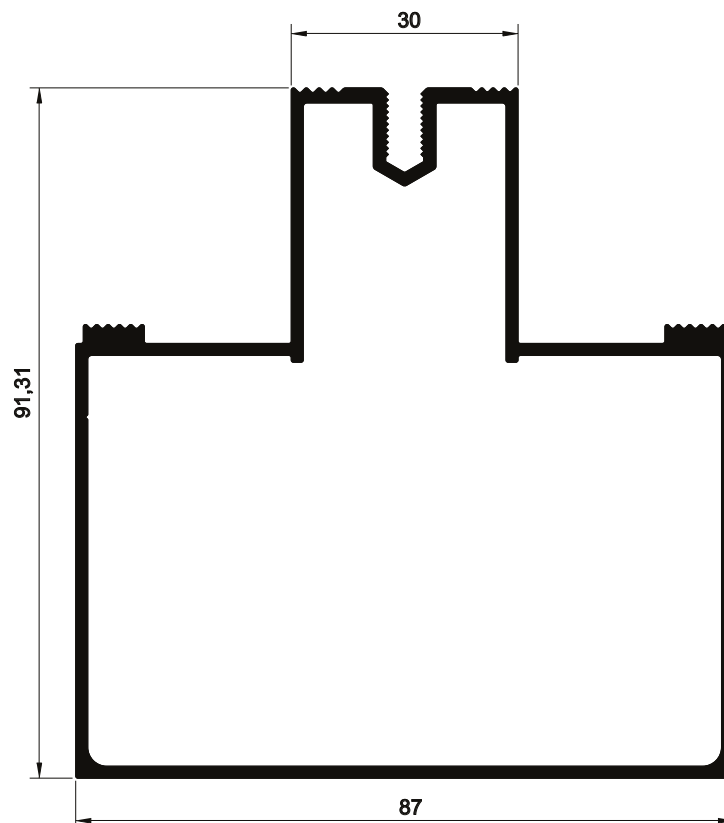

EFA-002
1,740 kg/m

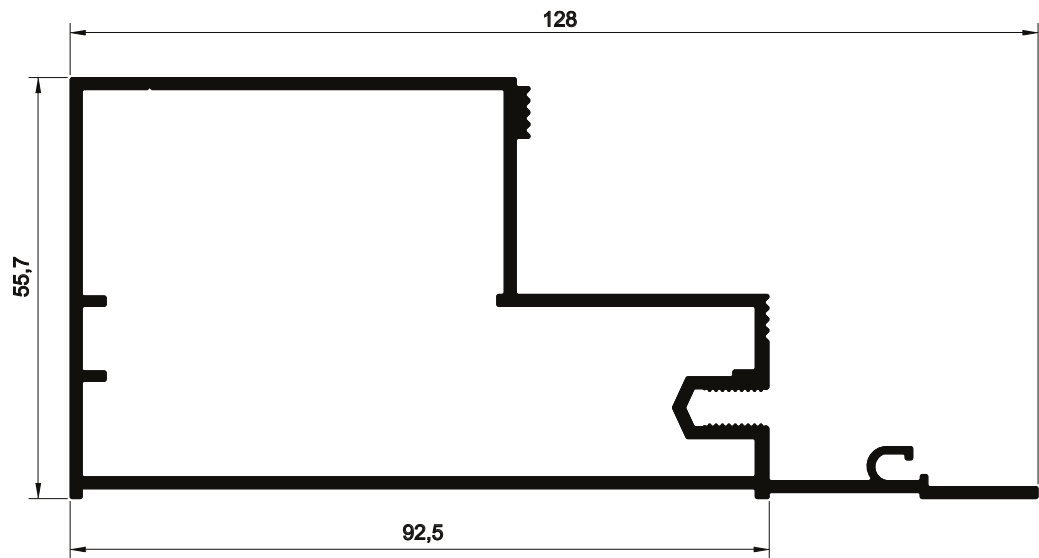

EFA-003
1,605 kg/m

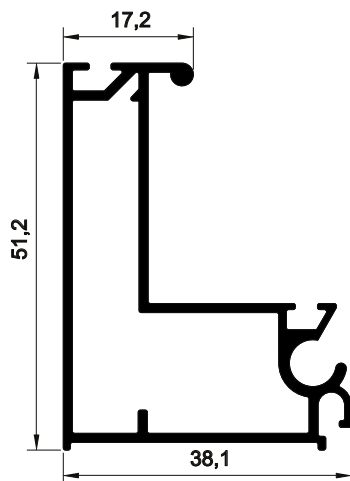

EFA-004
0,702 kg/m

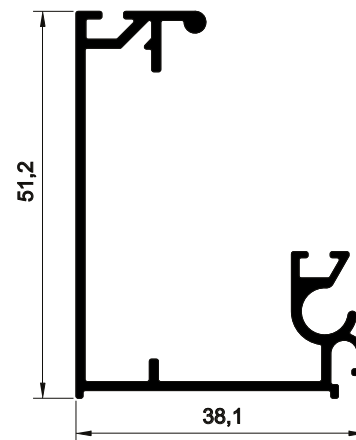

EFA-005
0,524 kg/m

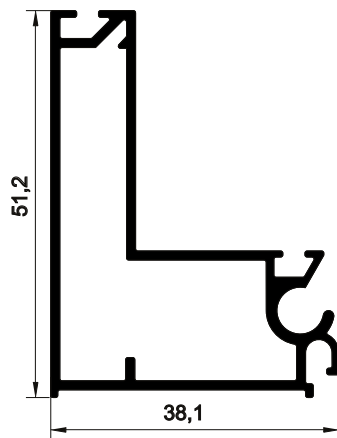

EFA-014
0,635 kg/m

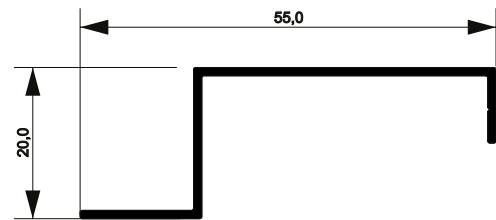

EFA-015
0,246 kg/m

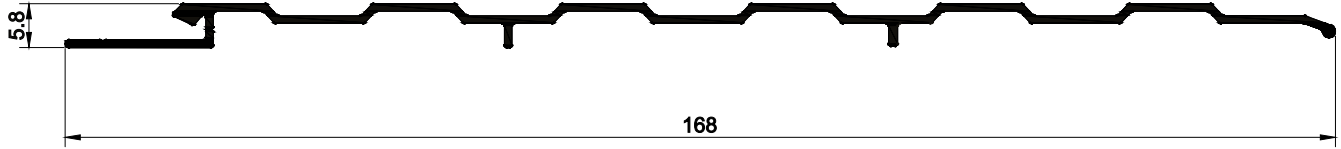

ELB-051
0,533 kg/m

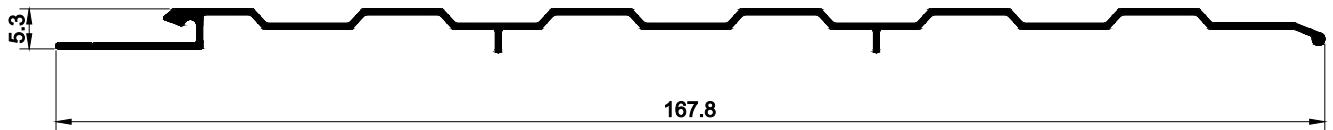

ELB-100
0,478 kg/m

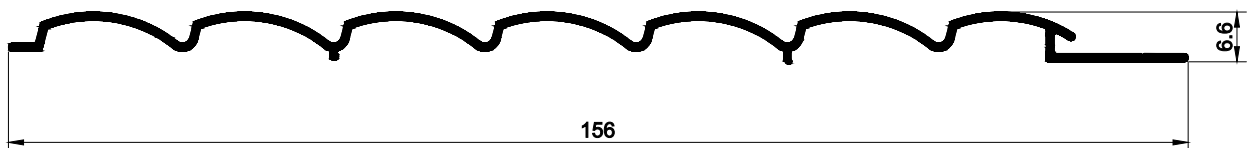

ELB-090
0,553 kg/m

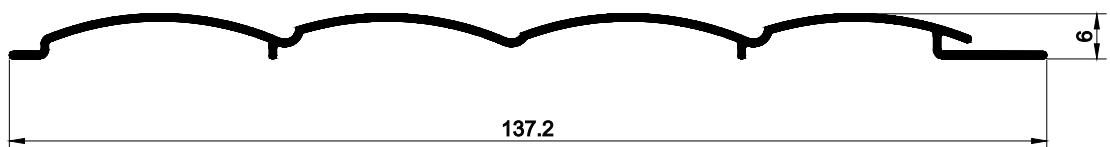

ELB-041
0,418 kg/m

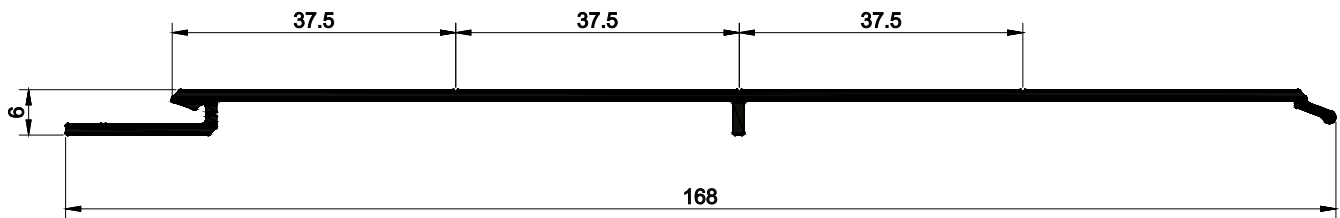

ELB-036
0,742 kg/m



ELB-037
0,602 kg/m

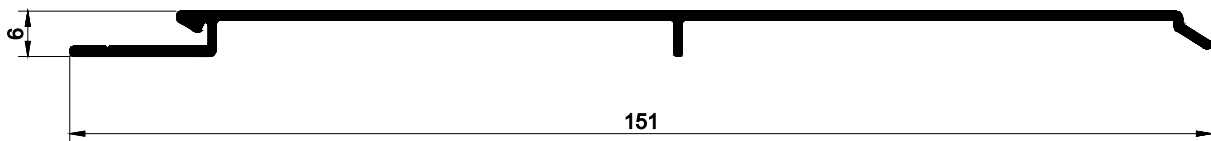

ELB-040
0,556 kg/m

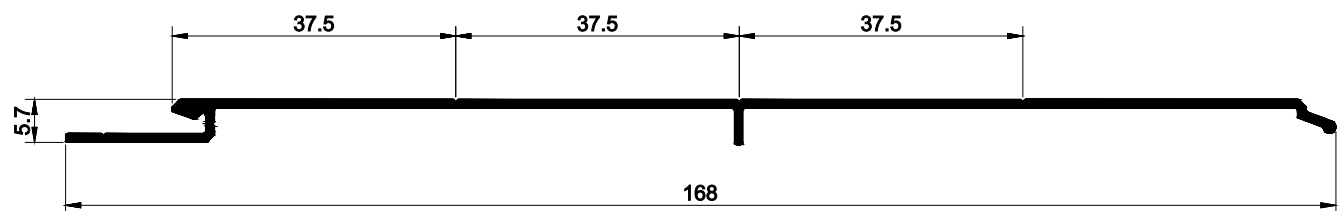

ELB-038
0,602 kg/m

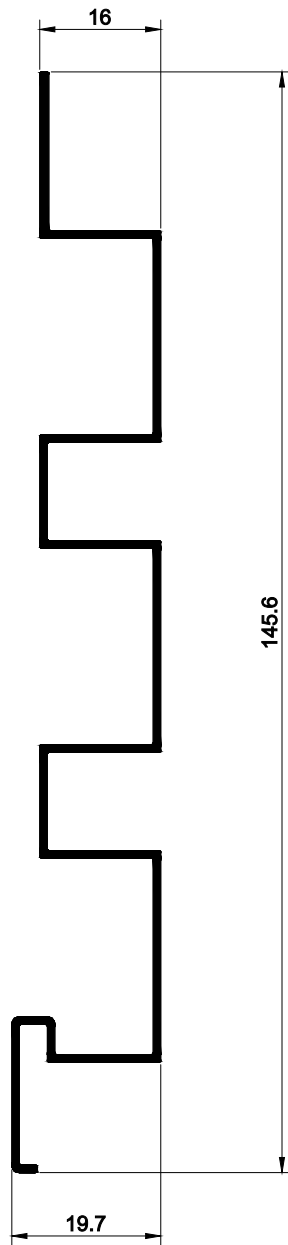

ELB-043
0,691 kg/m

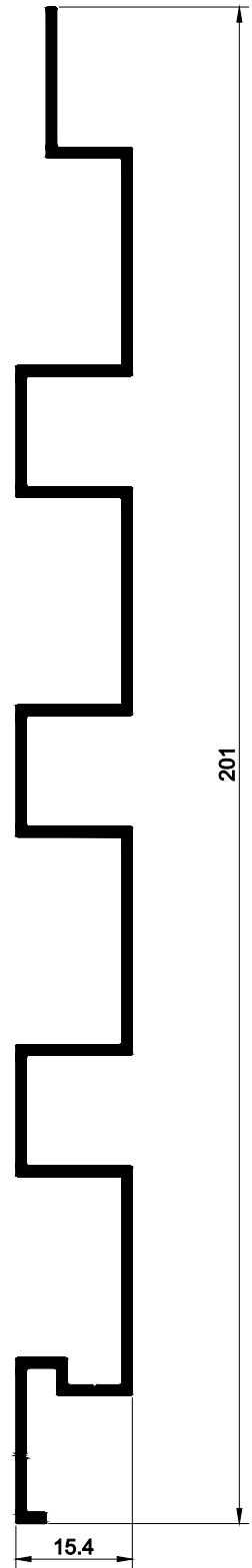

ELB-055
1,210 kg/m

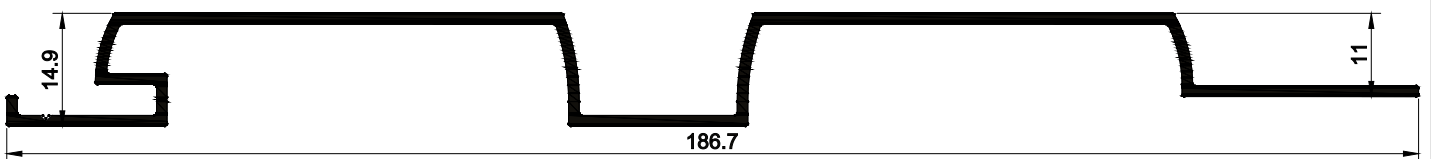

ELB-375
0,940 kg/m

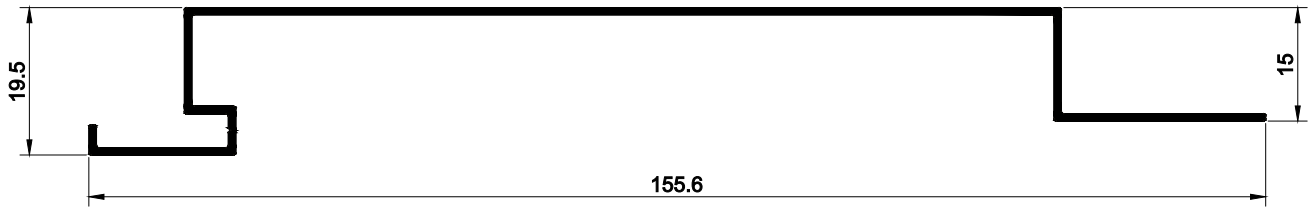

ELB-039
0,548 kg/m

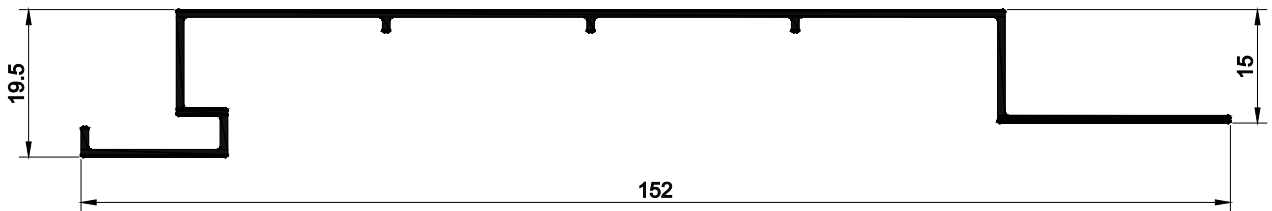

ELB-034
0,555 kg/m

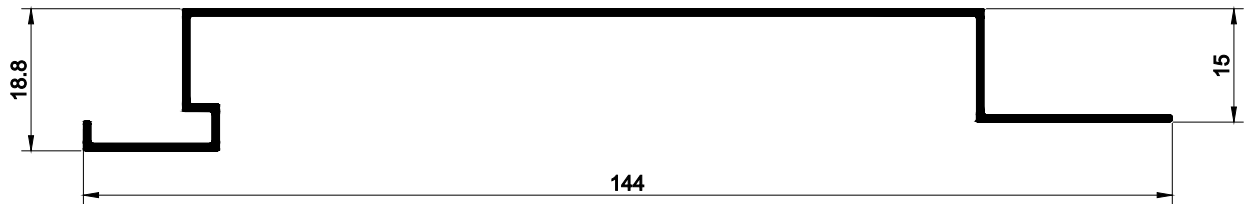

ELB-044
0,505 kg/m



ELB-091
0,528 kg/m

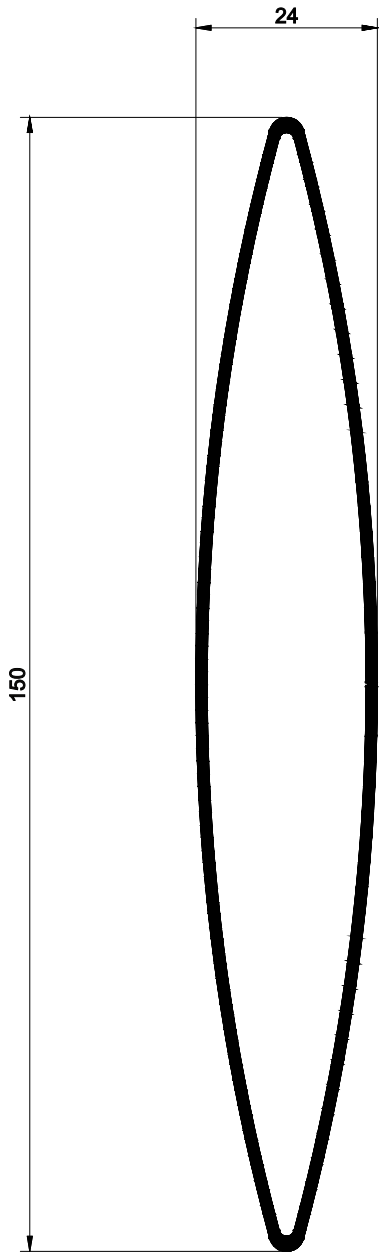

ELB-003
1,238 kg/m

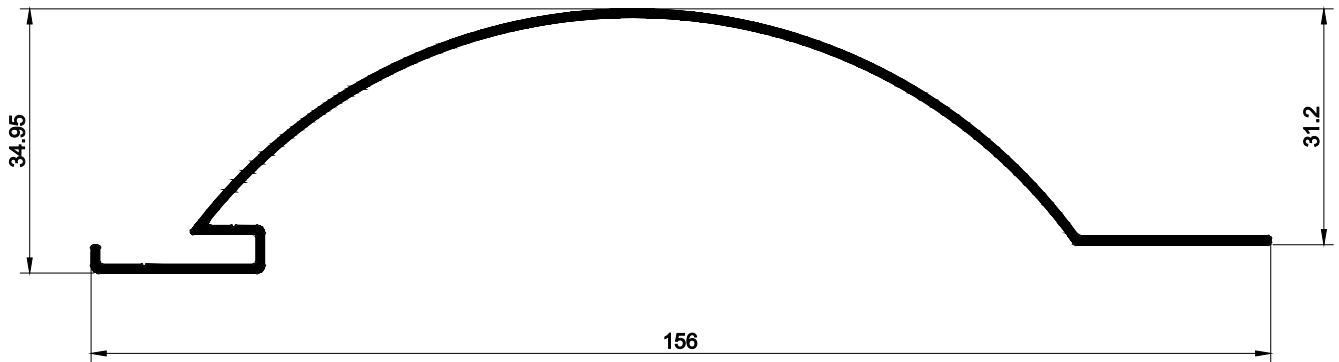

ELB-012
0,617 kg/m

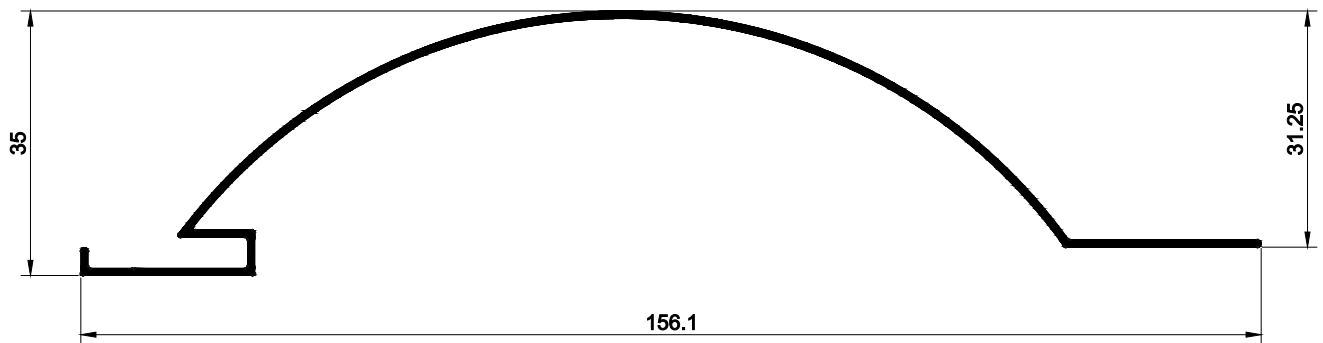

ELB-035
0,535 kg/m

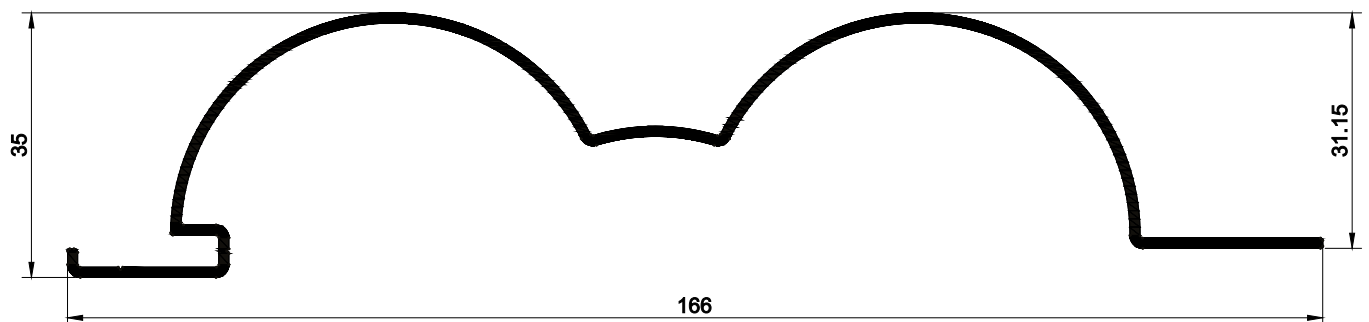

ELB-004
0,843 kg/m

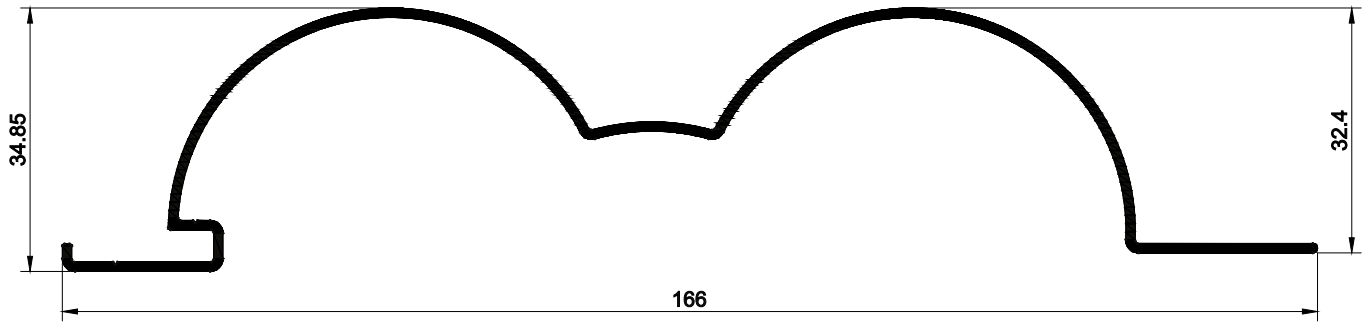

ELB-014
0,780 kg/m

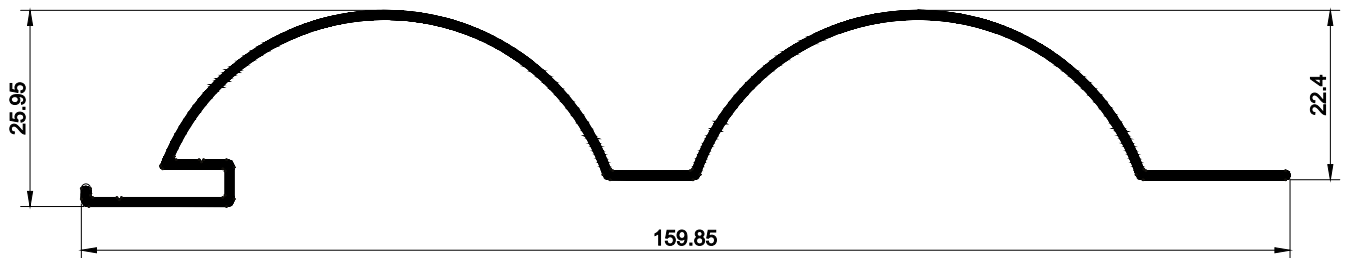

ELB-028
0,710 kg/m

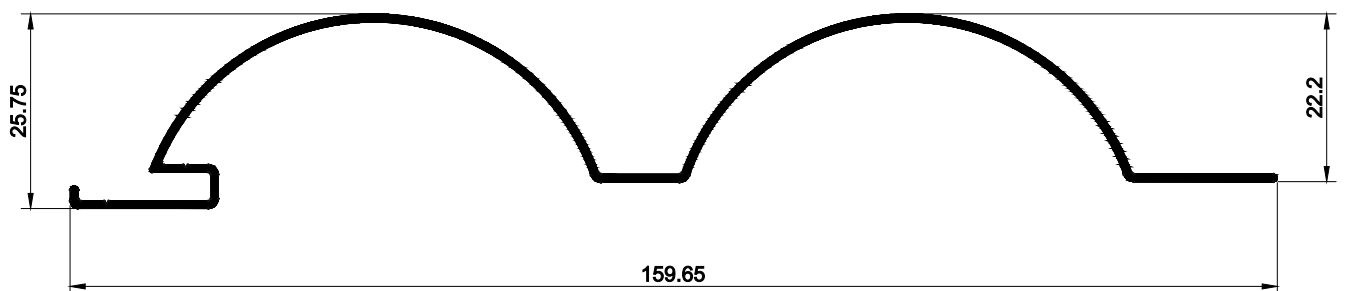

ELB-048
0,631 kg/m

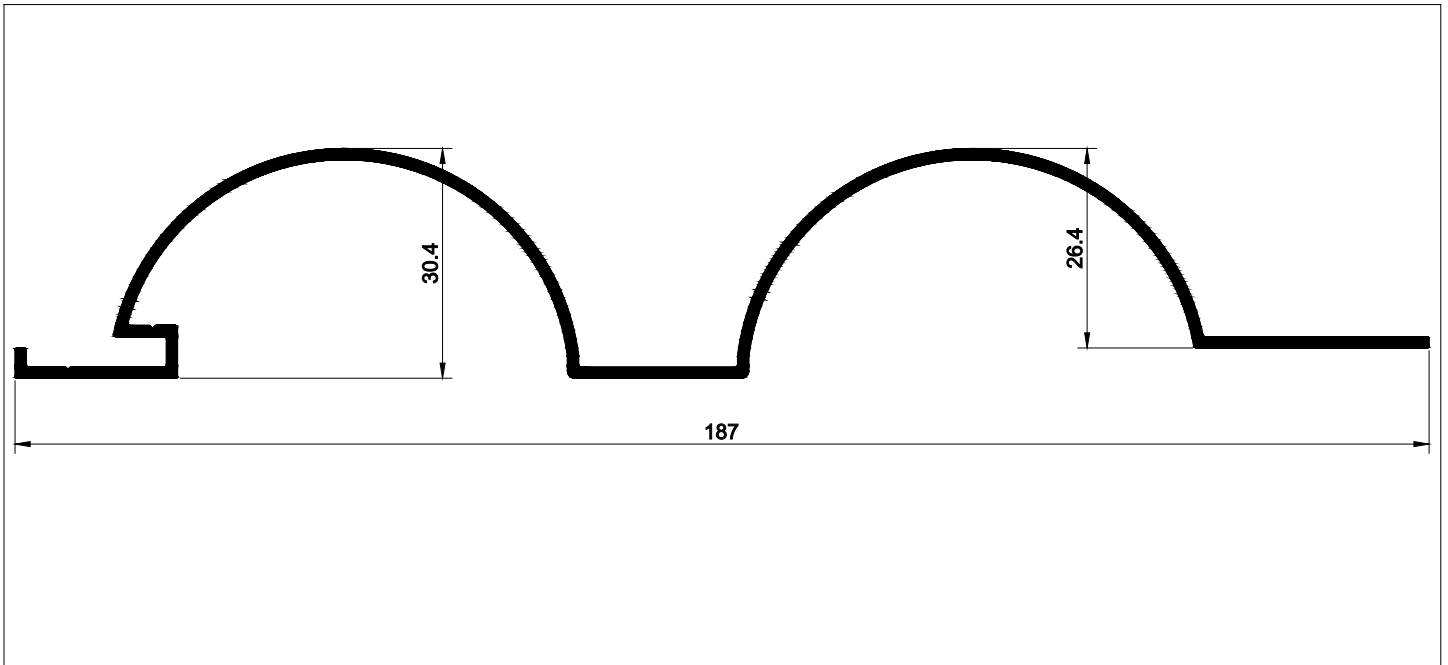

ELB-187
1,072 kg/m

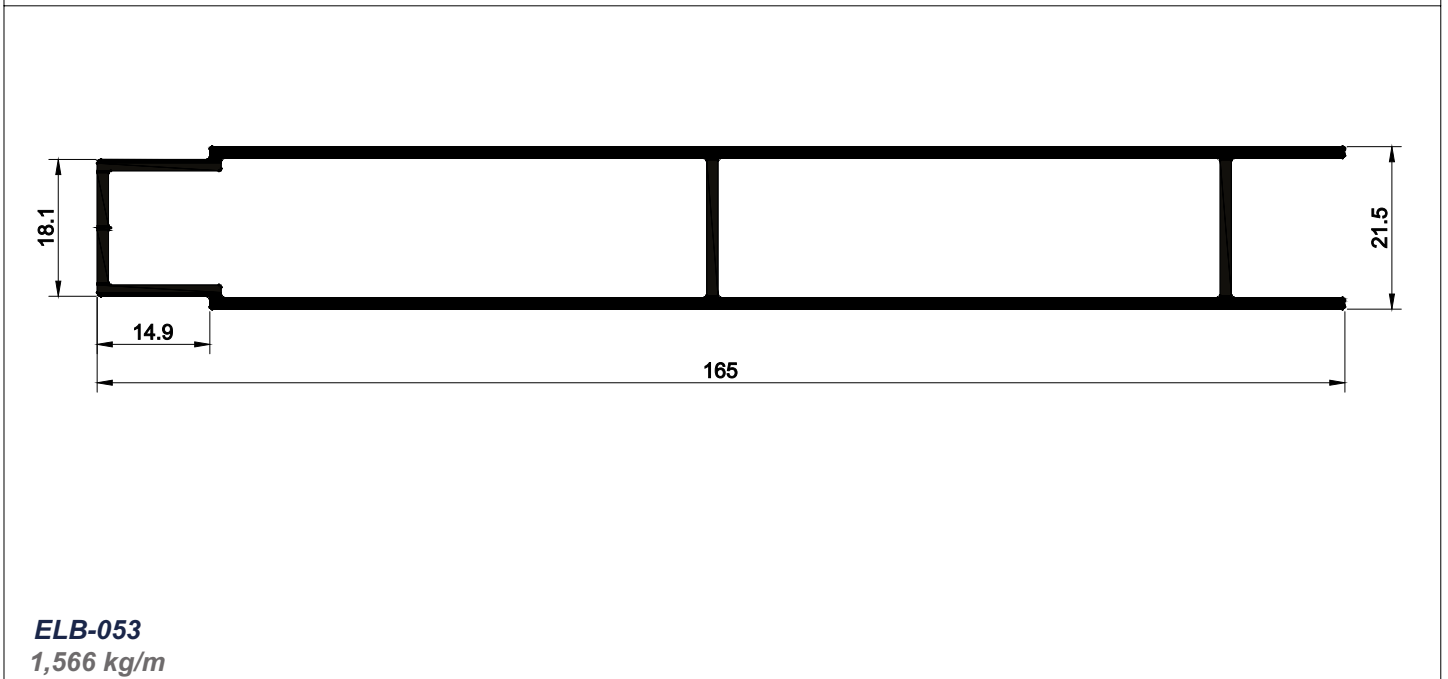

ELB-053
1,566 kg/m

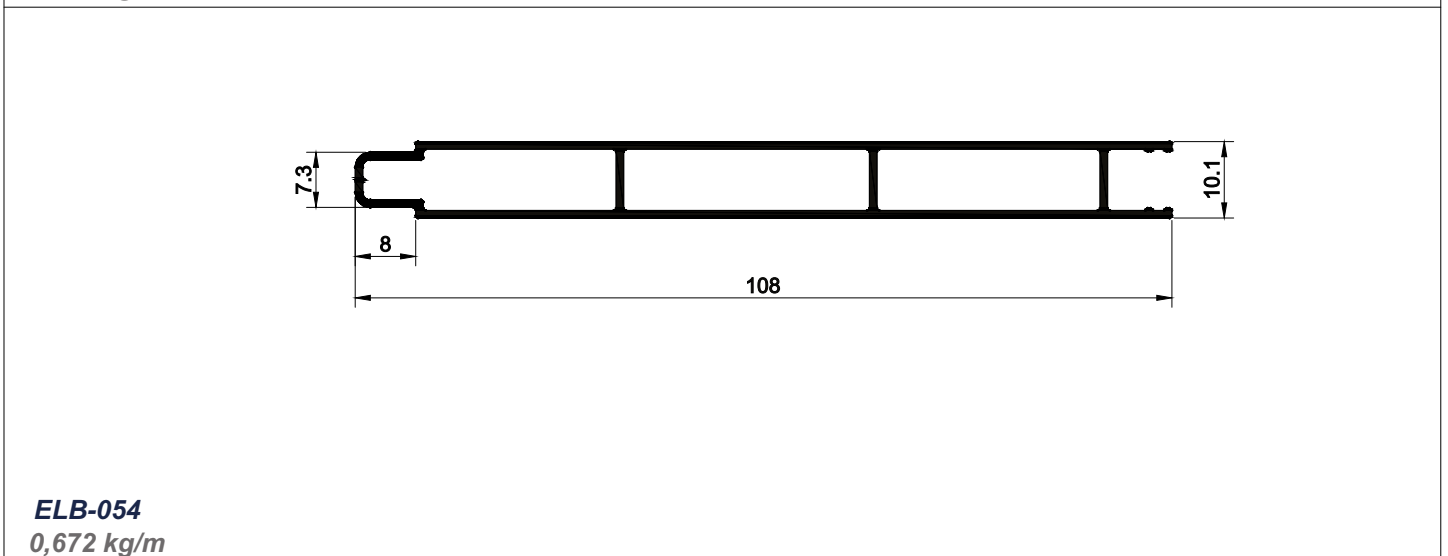

ELB-054
0,672 kg/m

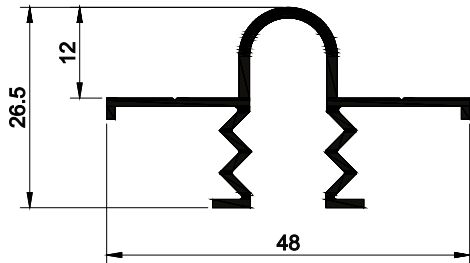

EPO-021
0,365 kg/m

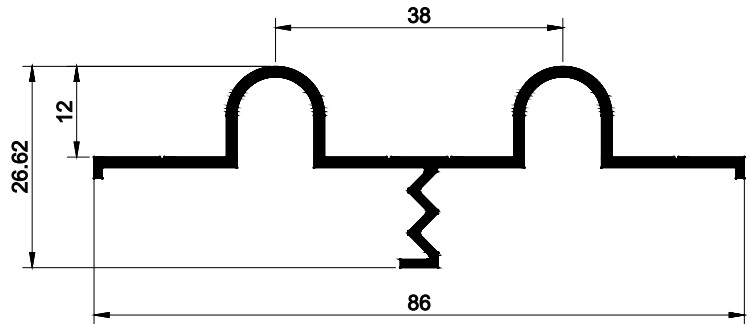

EPO-022
0,543 kg/m

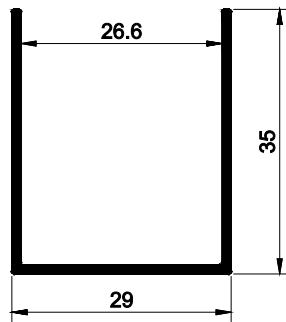

EPU-639
0,314 kg/m

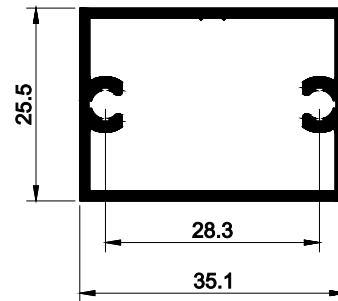

EPO-055
0,505 kg/m

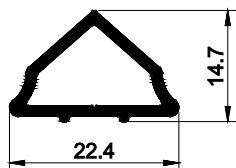

EPO-081
0,209 kg/m

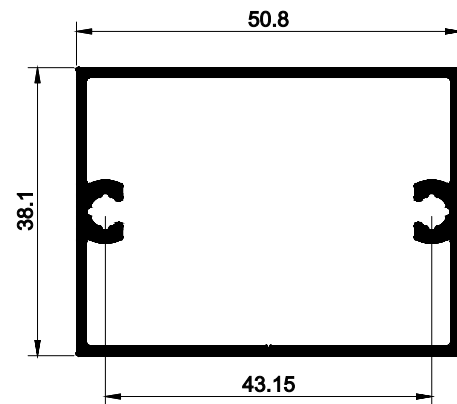

EPO-103
0,729 kg/m

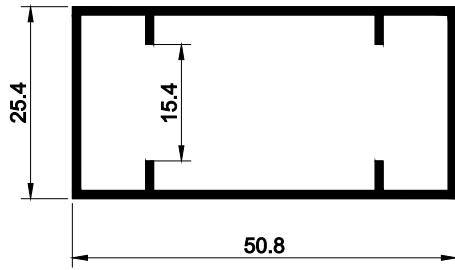

EPO-079
0,484 kg/m

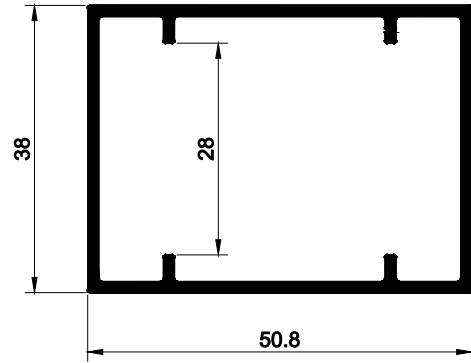

EPO-078
0,754 kg/m

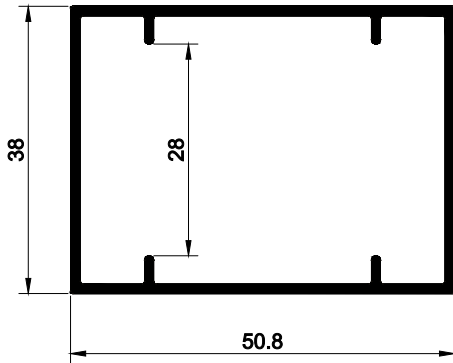

EPO-078L
0,654 kg/m

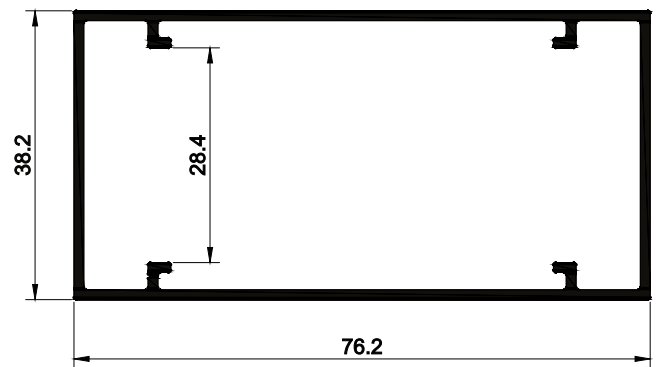

EPO-069
0,862 kg/m

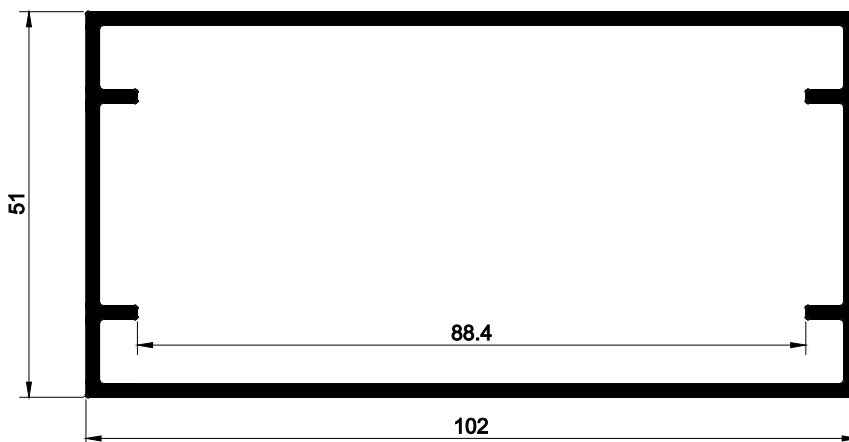

EPO-080
1,555 kg/m

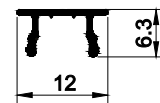

EVT-053
0,047 kg/m

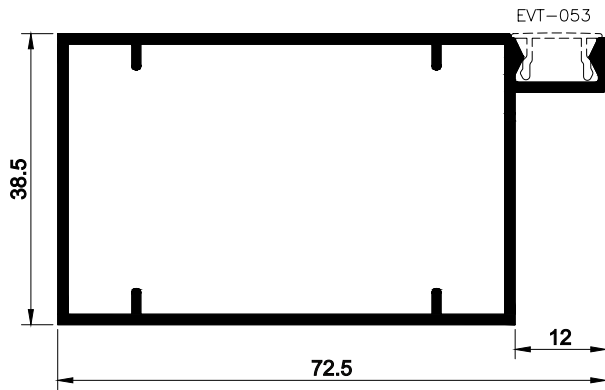

EPO-778
0,847kg/m

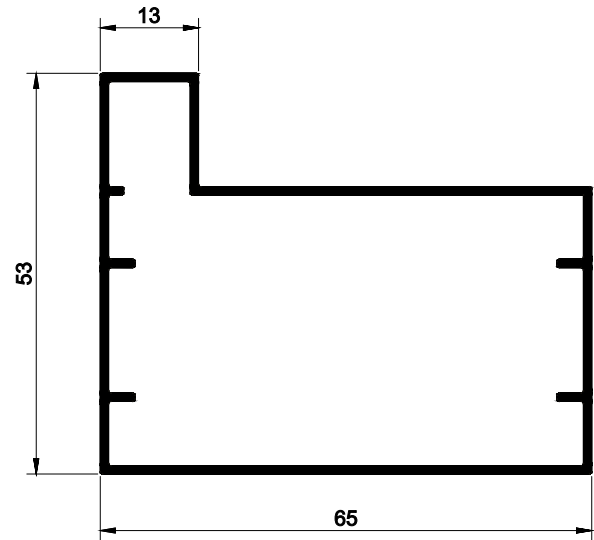

EPO-501
0,738kg/m

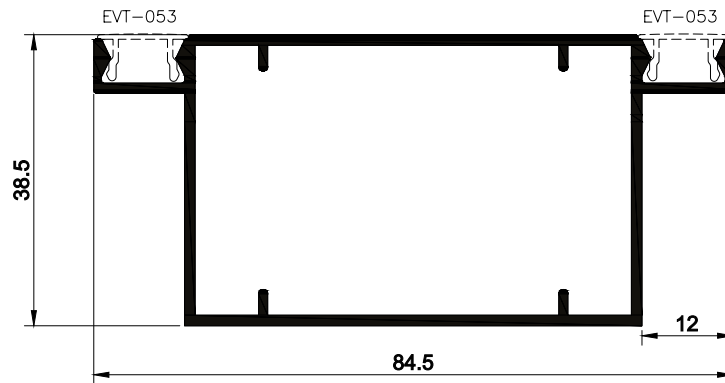

EPO-777
0,921kg/m

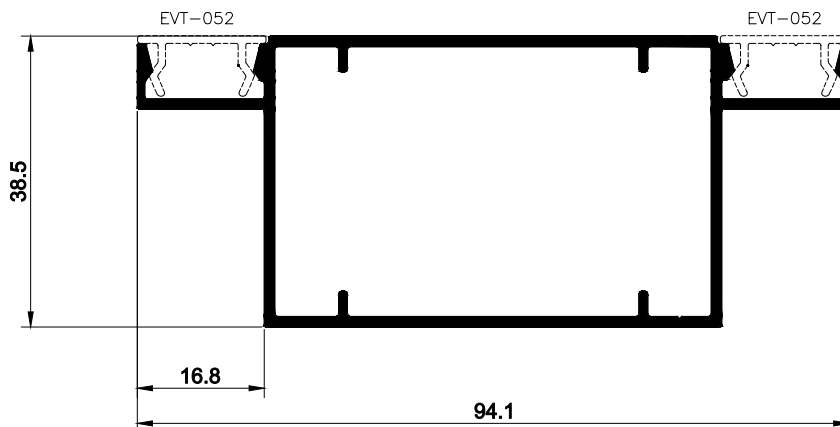

EPO-780
0,971kg/m

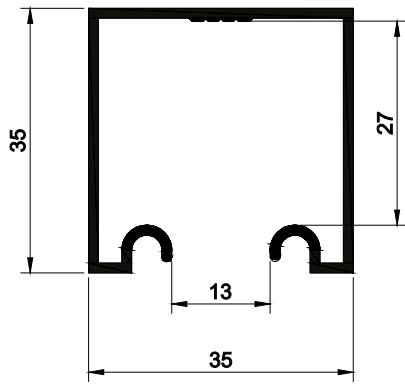

EPO-266
0,480 kg/m

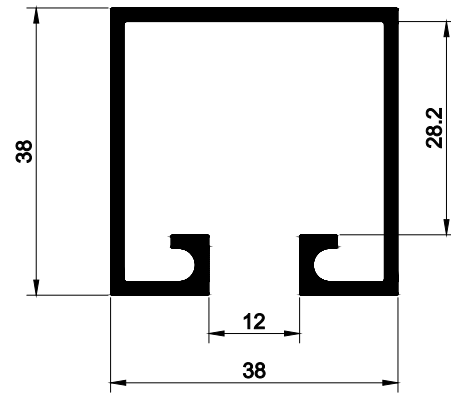

EPO-990
0,751 kg/m

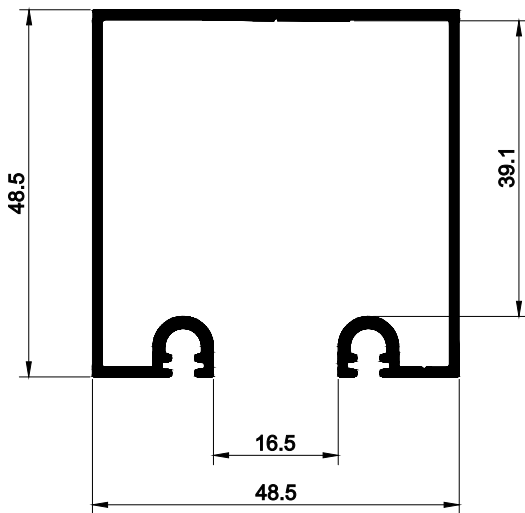

EVT-002
0,723 kg/m

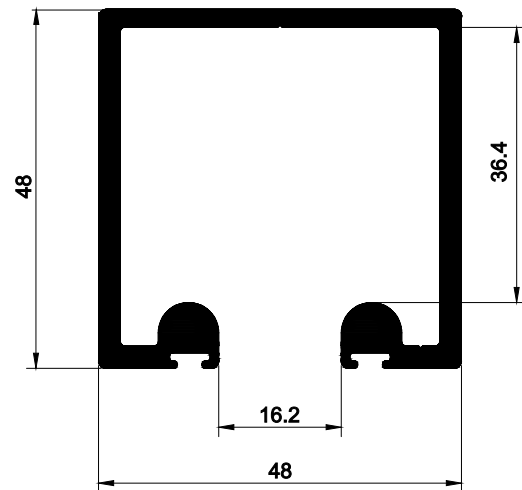

EVT-006
1,458 kg/m

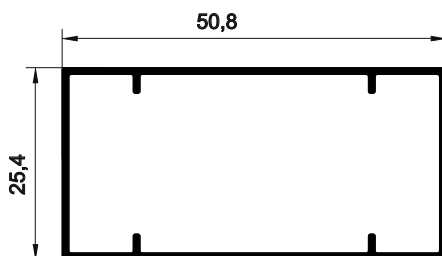

EPO-079L
0,387 kg/m

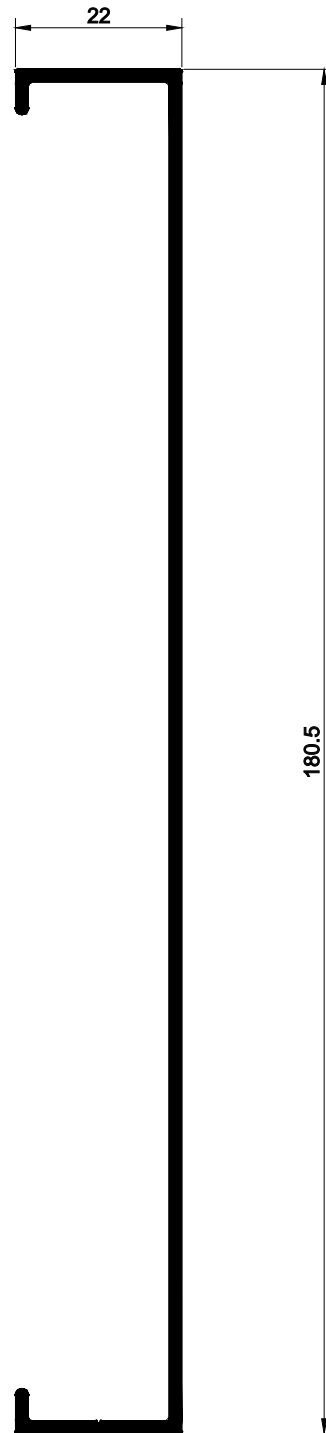

EPO-110
1,057 kg/m

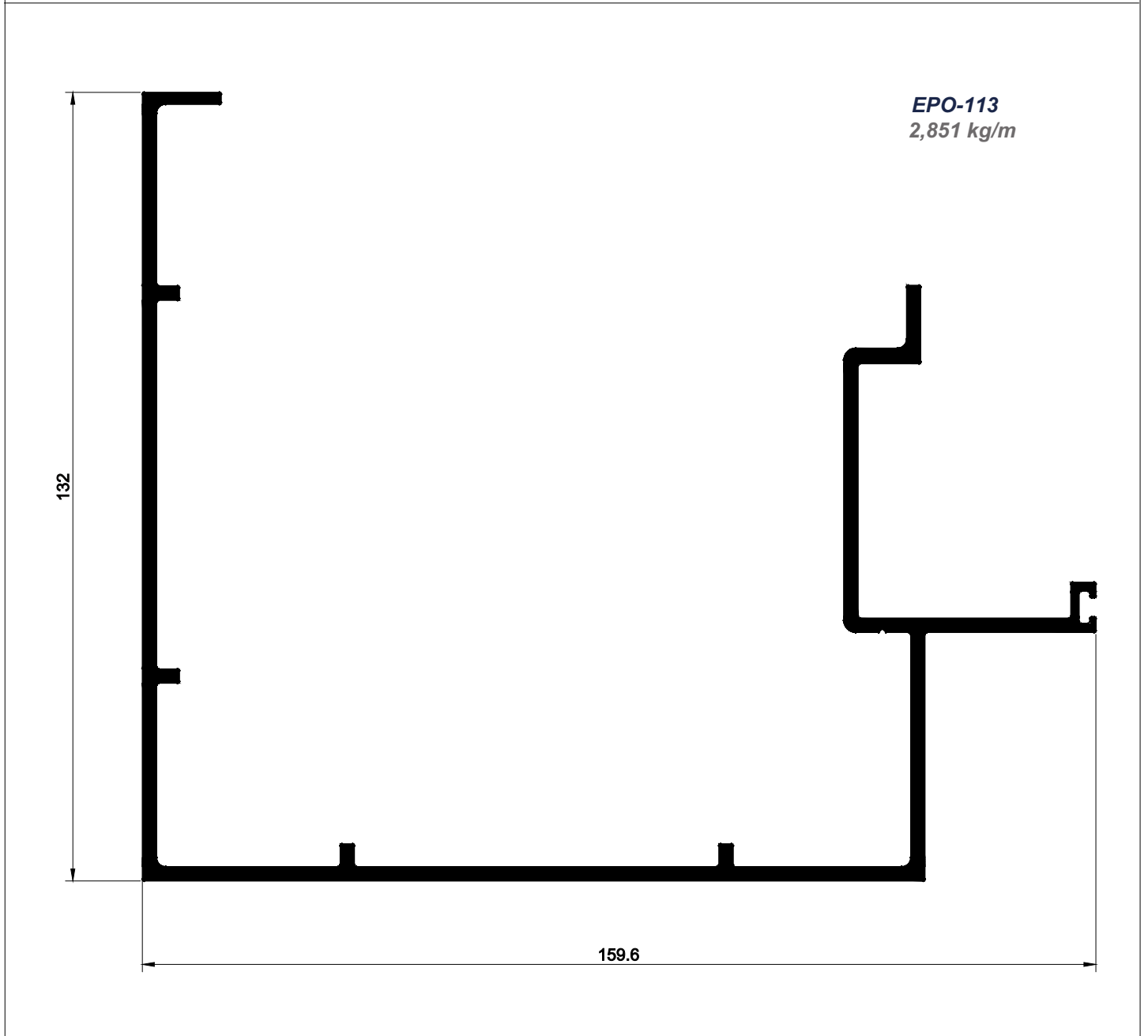
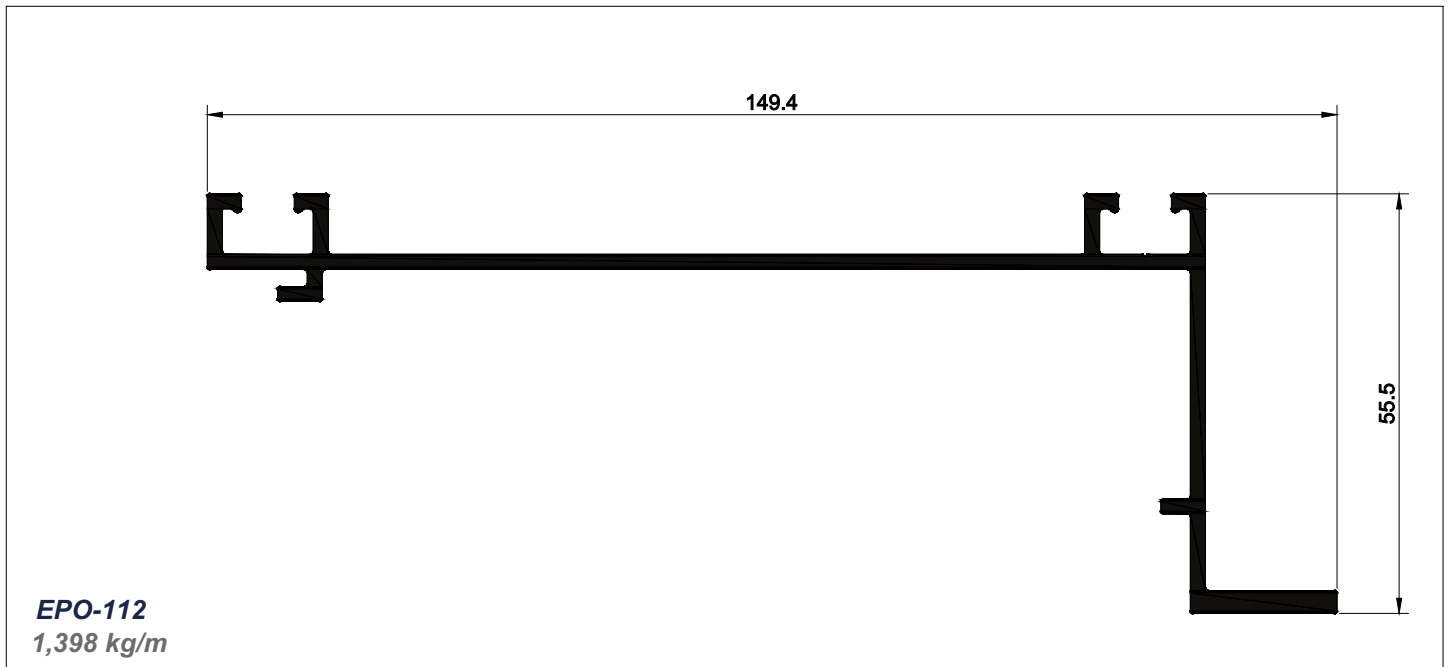



EGR-074
0,240 kg/m

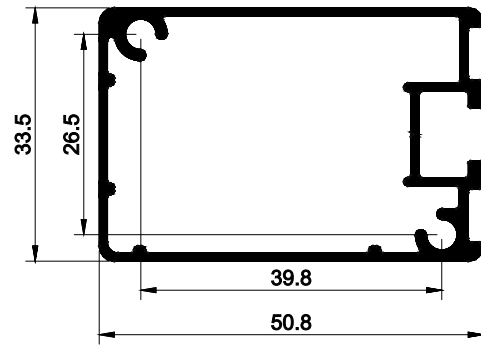

EGR-077
0,688 kg/m

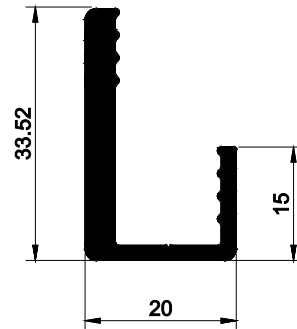

EGR-075
0,523 kg/m

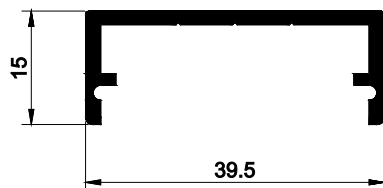

EGR-496
0,341 kg/m

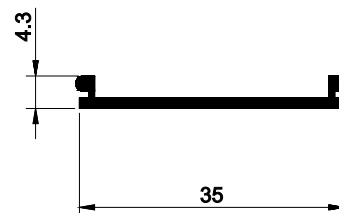

EGR-495
0,161 kg/m

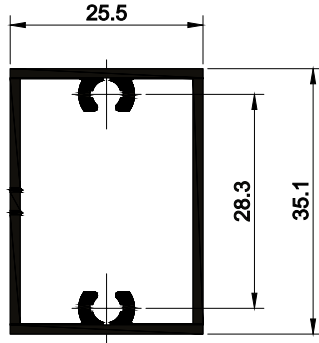

EGR-001
0,506 kg/m

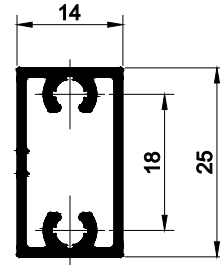

EGR-002
0,321 kg/m

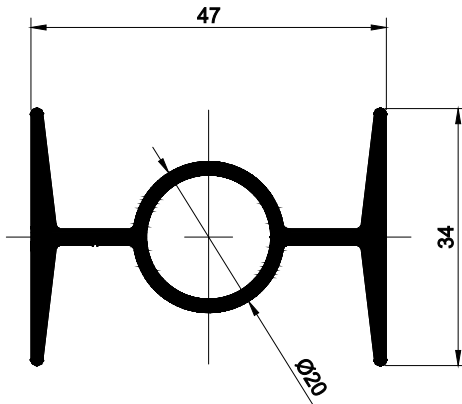

EGR-100
0,860 kg/m

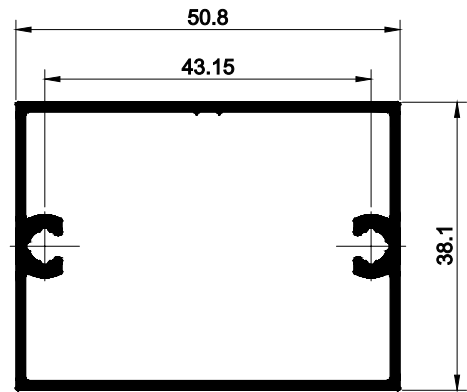

EPO-103
0,729 kg/m

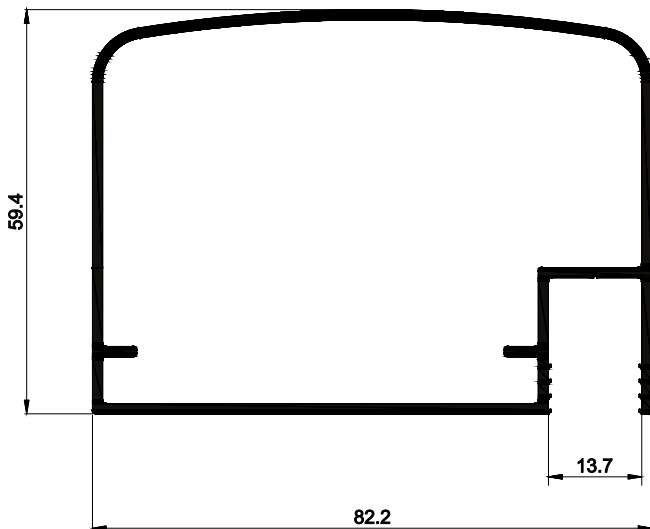

EGR-085
1,206 kg/m

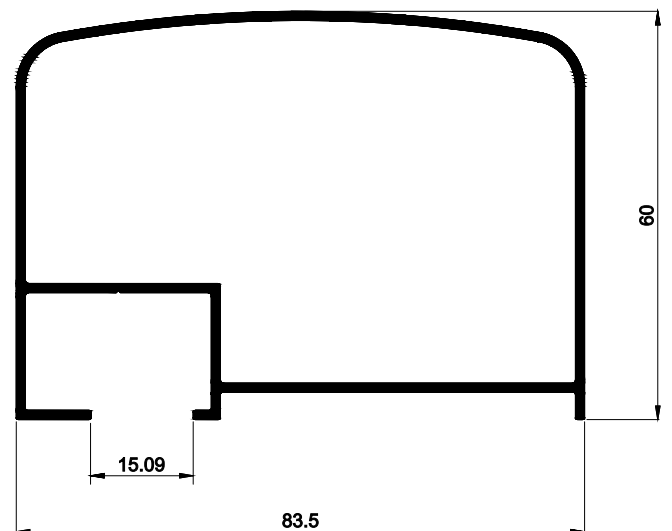

EGR-500
1,100 kg/m

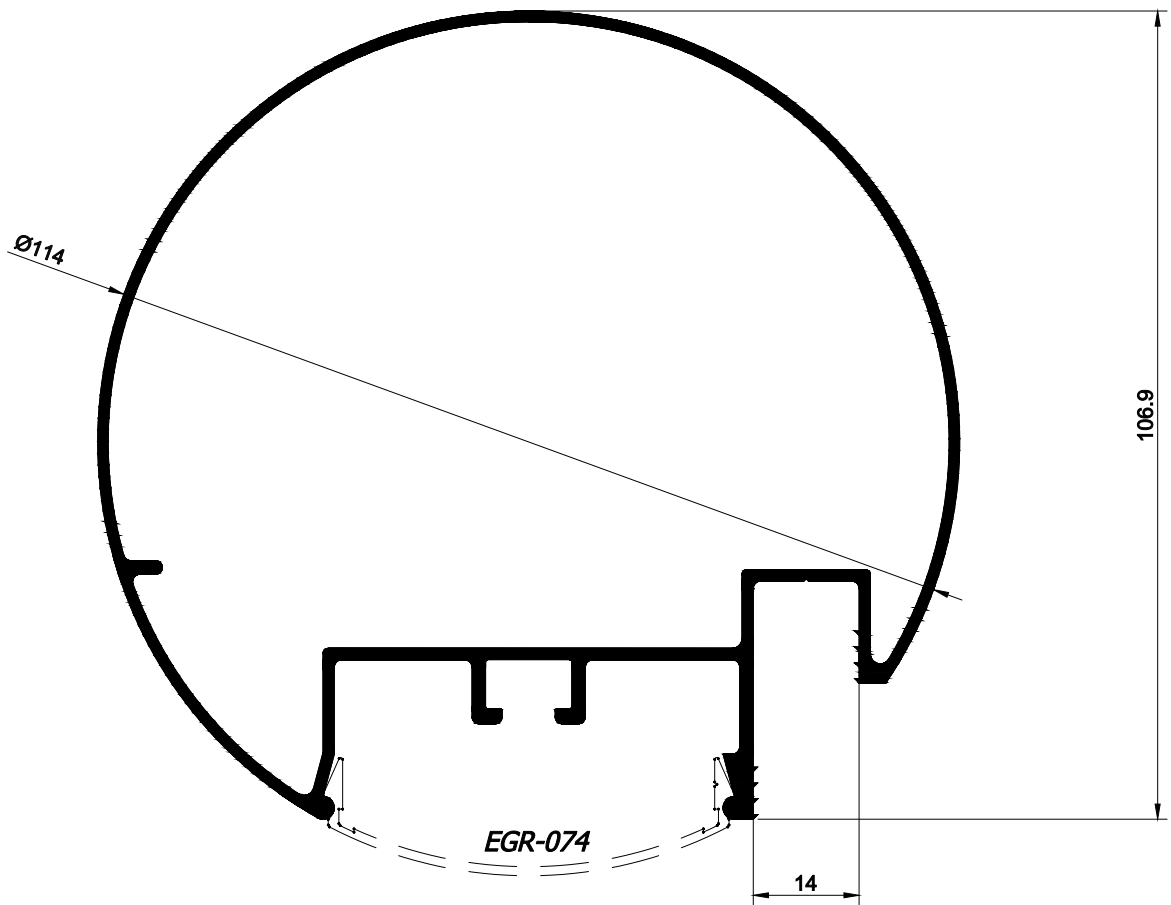

EGR-143
1,794 kg/m

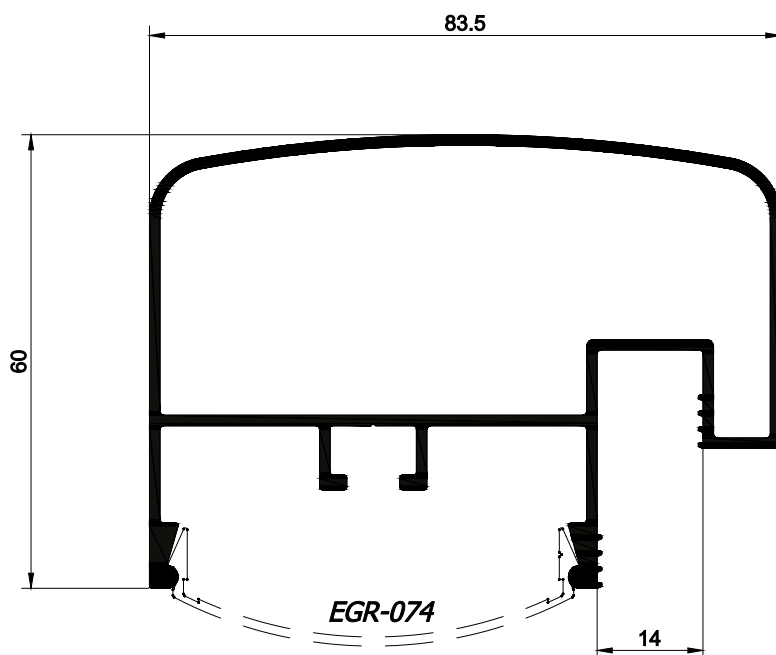

EGR-083
1,301 kg/m

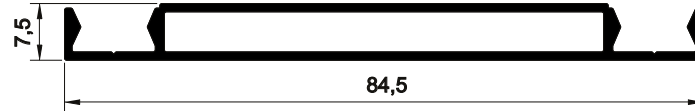

EFA-006
0,525 kg/m

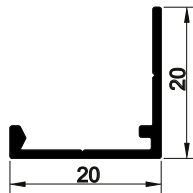

EFA-007
0,138 kg/m

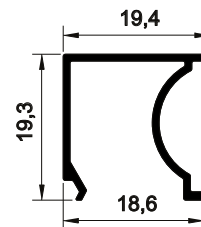

EFA-008
0,154 kg/m

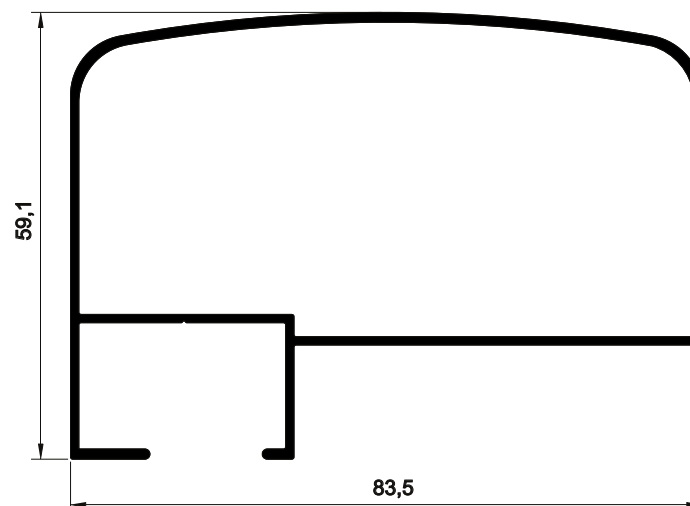

EFA-009
0,939 kg/m

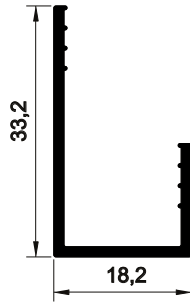

EFA-010
0,237 kg/m

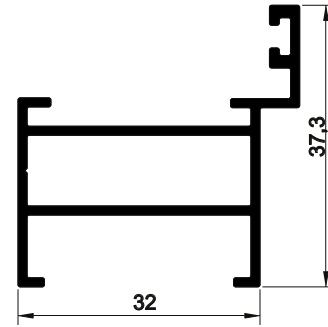

EFA-011
0,477 kg/m

CORRIMÃO

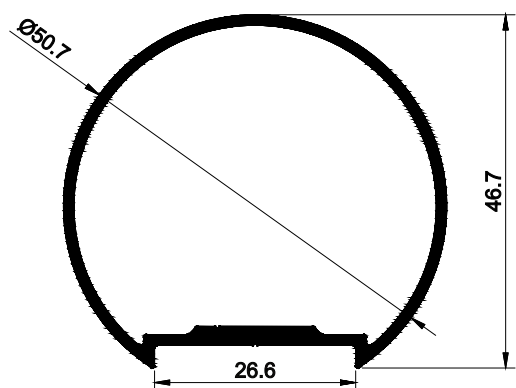

ECR-097
0,650 kg/m

CORRIMÃO

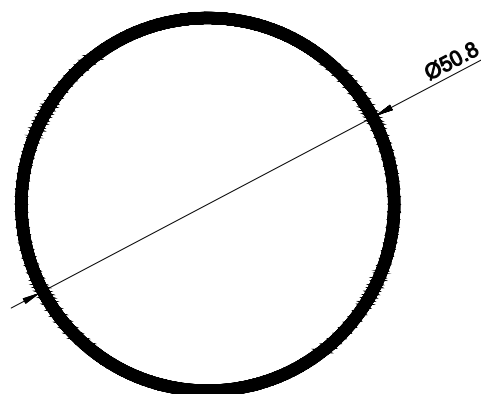

ETR-025
0,631 kg/m

CORRIMÃO

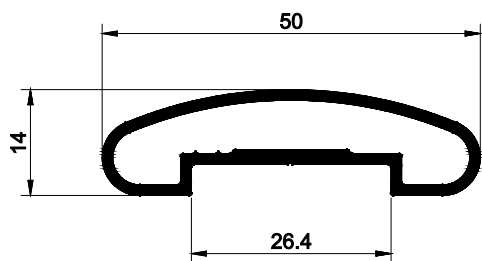

ECR-095
0,463 kg/m

BASE CORRIMÃO

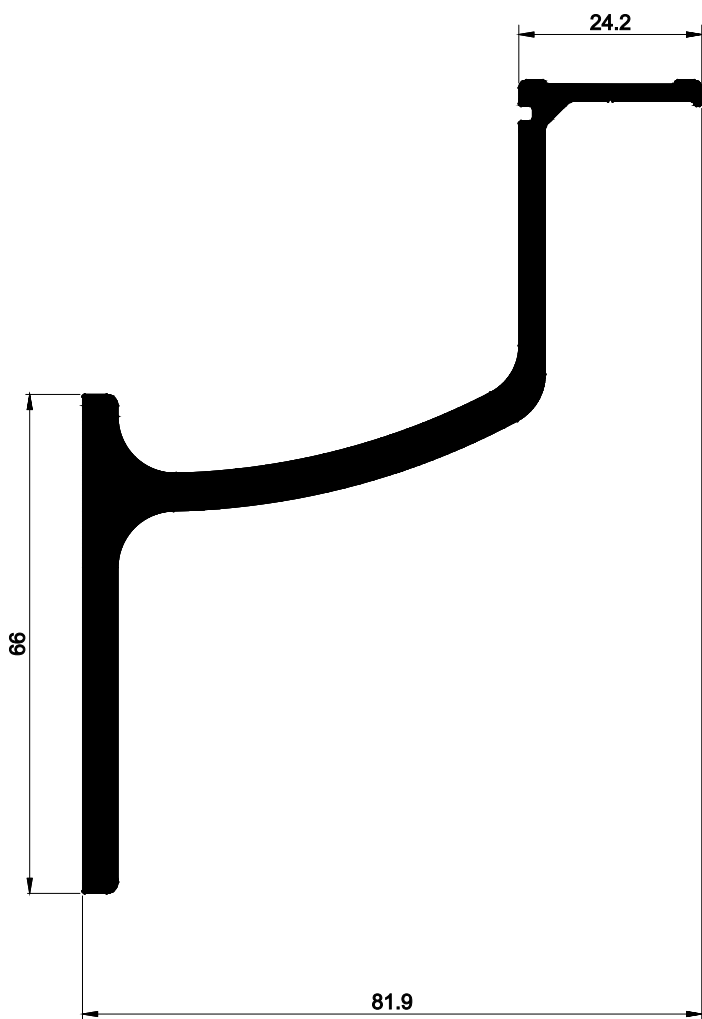

ECR-021
2,206 kg/m

PERFIL QUADRO

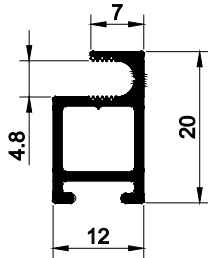

E25-547
0,206 Kg/m

PERFIL QUADRO

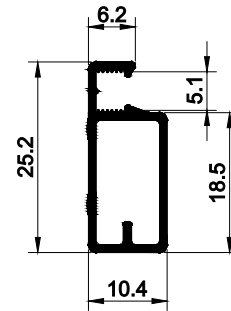

E25-551
0,196 kg/m

PERFIL QUADRO

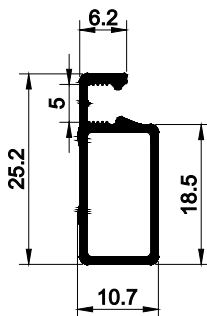

E25-600
0,190 Kg/m

PERFIL QUADRO

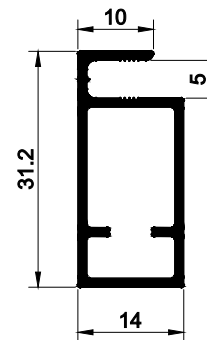

E25-601
0,306 kg/m

PERFIL QUADRO

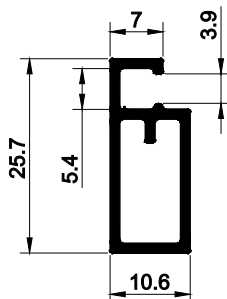

E25-602
0,249 Kg/m

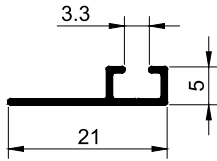

EMV-006
0,065 kg/m

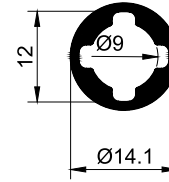

EPS-2304
0,200 kg/m

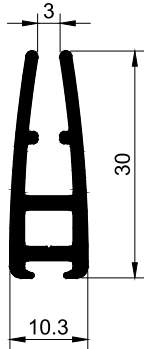

EPS-4217
0,344 kg/m

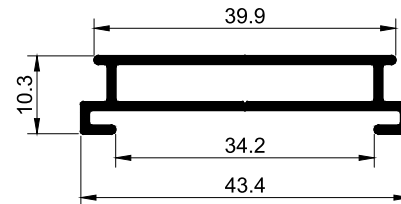

EPS-1524
0,317 kg/m

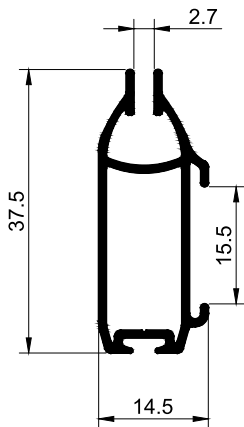

EPS-0448
0,309 kg/m

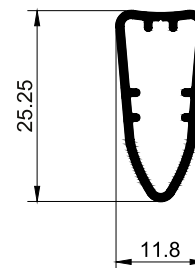

EPS-2303
0,182 kg/m

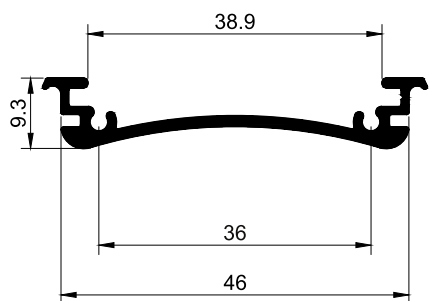

EPS-5905
0,303 Kg/m

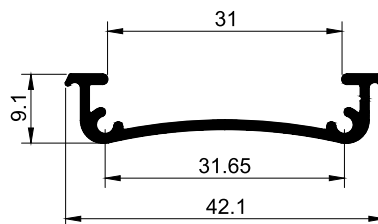

EPS-5904
0,219 Kg/m

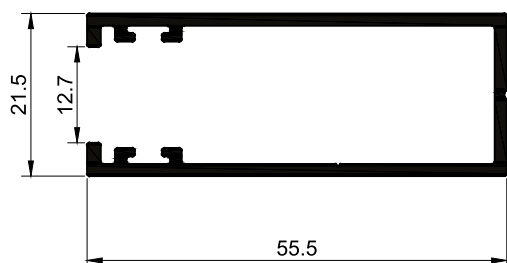

EPS-1304
0,634 Kg/m

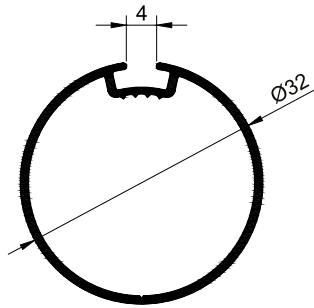

EPS-2167
0,282 kg/m

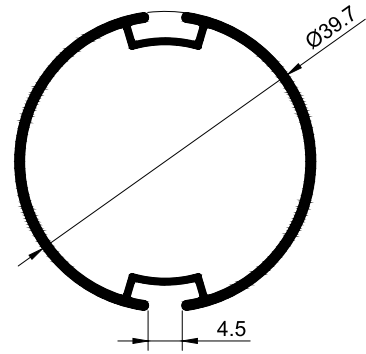

EPS-1221
0,425 kg/m

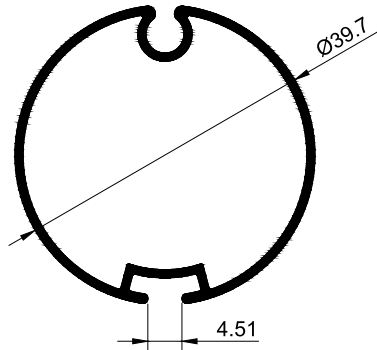

EPS-816
0,434 kg/m

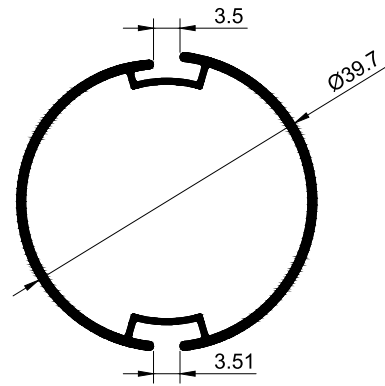

EPS-5793
0,427 kg/m

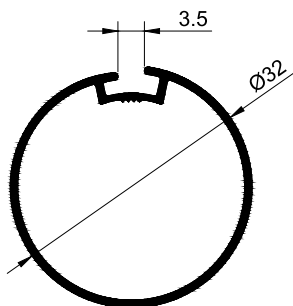

EPS-5824
0,285 kg/m

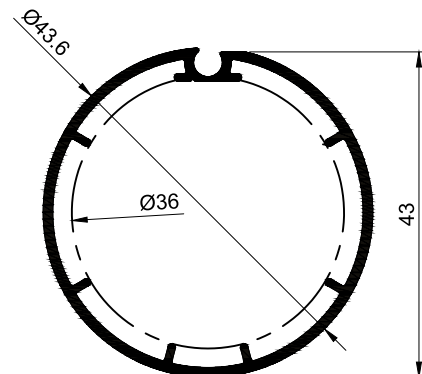

EPS-1740
0,523 kg/m

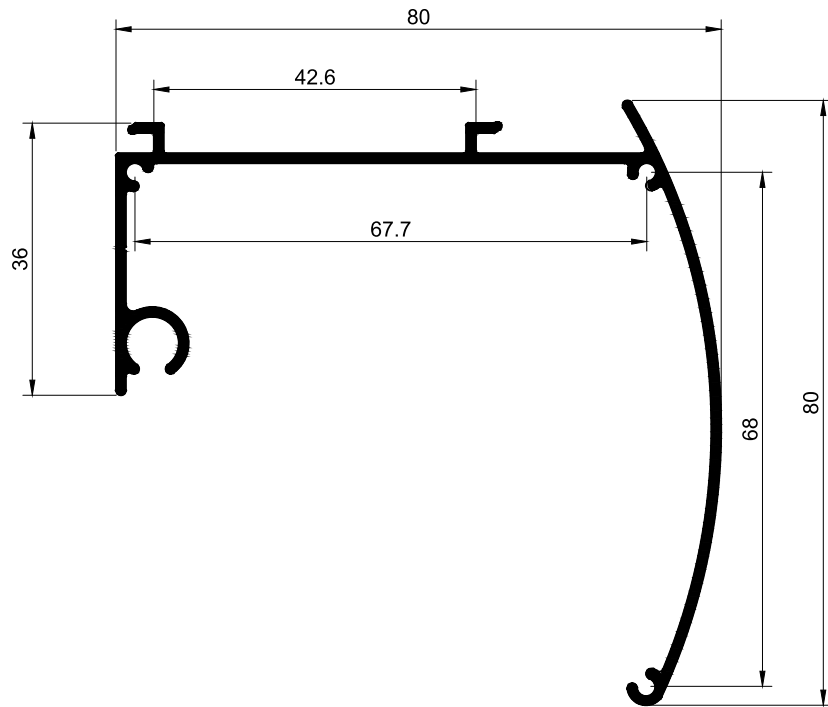

EPS-4297
0,808 kg/m

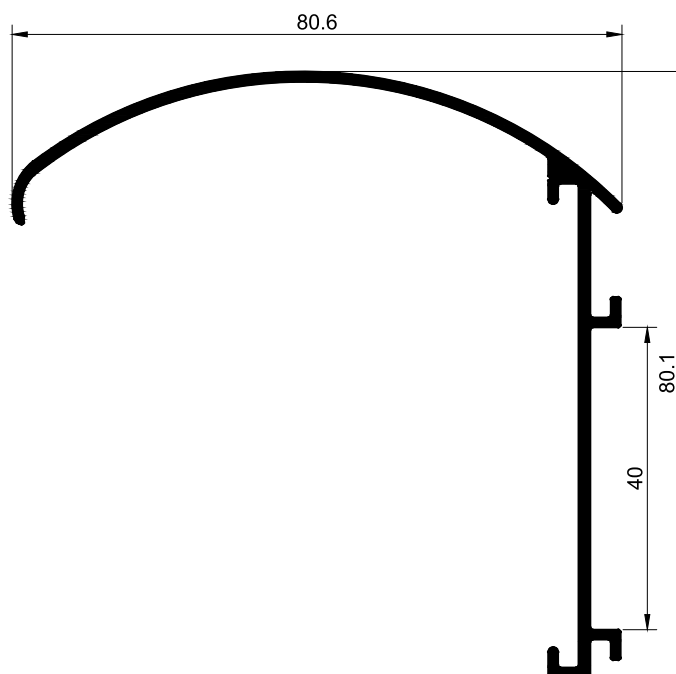

EPS-1720
0,729 kg/m

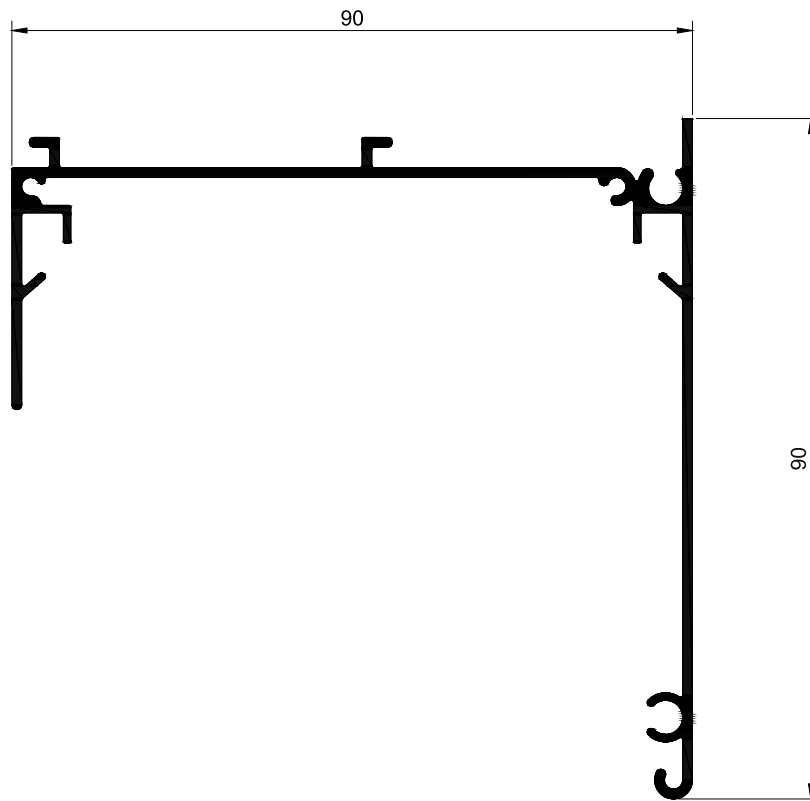

EPS-272
0,947 kg/m

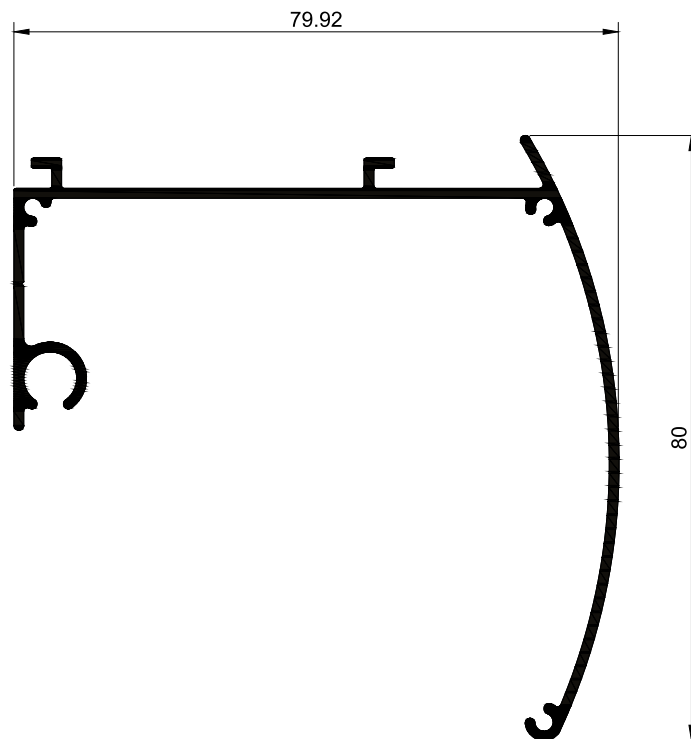

EPS-4297
0,807 kg/m

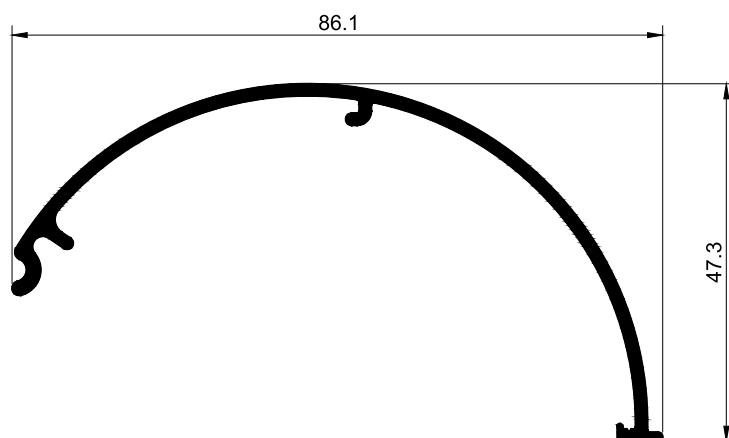

EPS-2307
0,604 kg/m

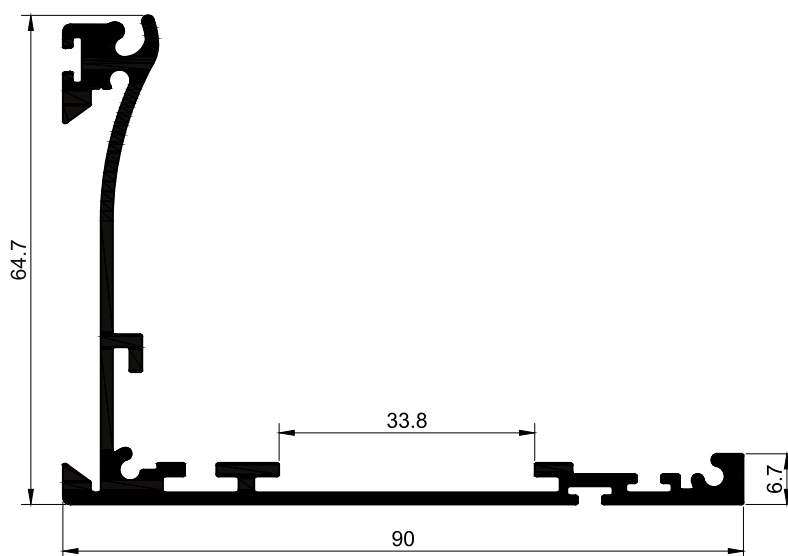

EPS-2306
1,170 kg/m

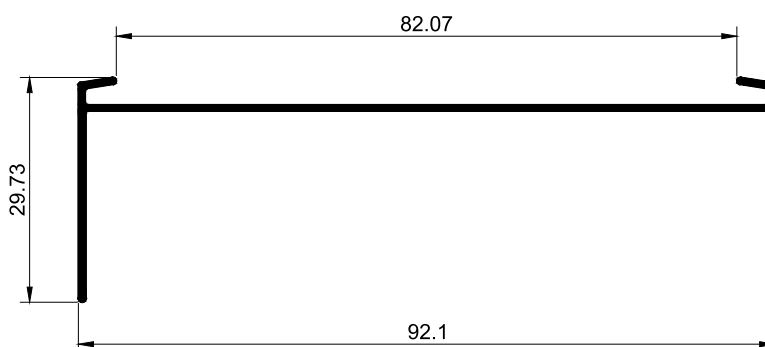

EPS-0190
0,296 kg/m

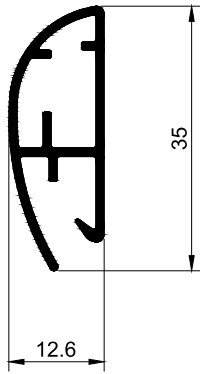

EPS-6354
0,293 kg/m

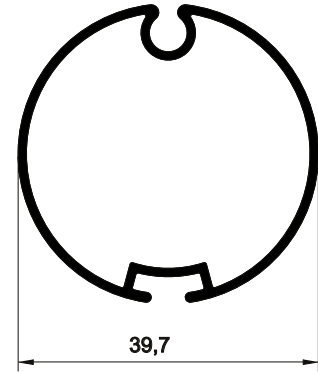

EPS-816
0,435 kg/m



EPS-0359
0,041 kg/m



EPS-0654
0,096 kg/m

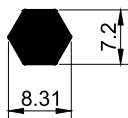

EPS-1487
0,122 kg/m

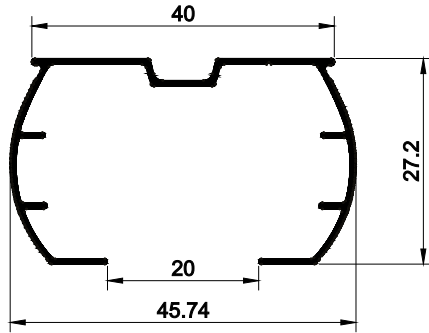

EPS-1669
0,266 kg/m

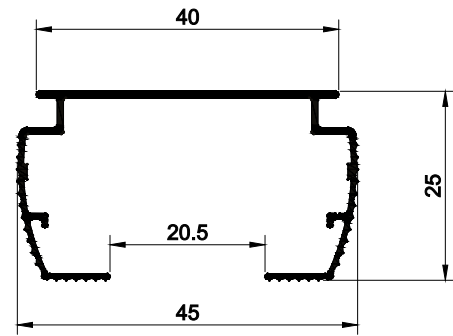

EPS-1229
0,260 kg/m

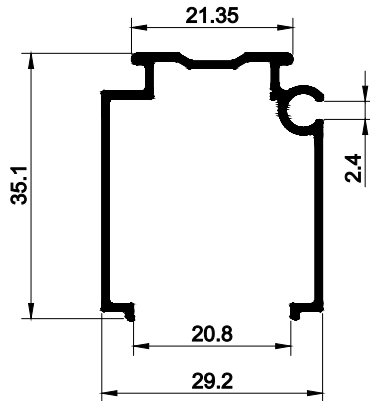

EPS-3167
0,312 kg/m



EPS-0313
0,046 kg/m

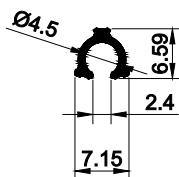

EPS-1587
0,043 kg/m

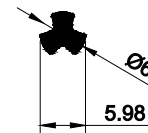

EPS-0374
0,054 kg/m

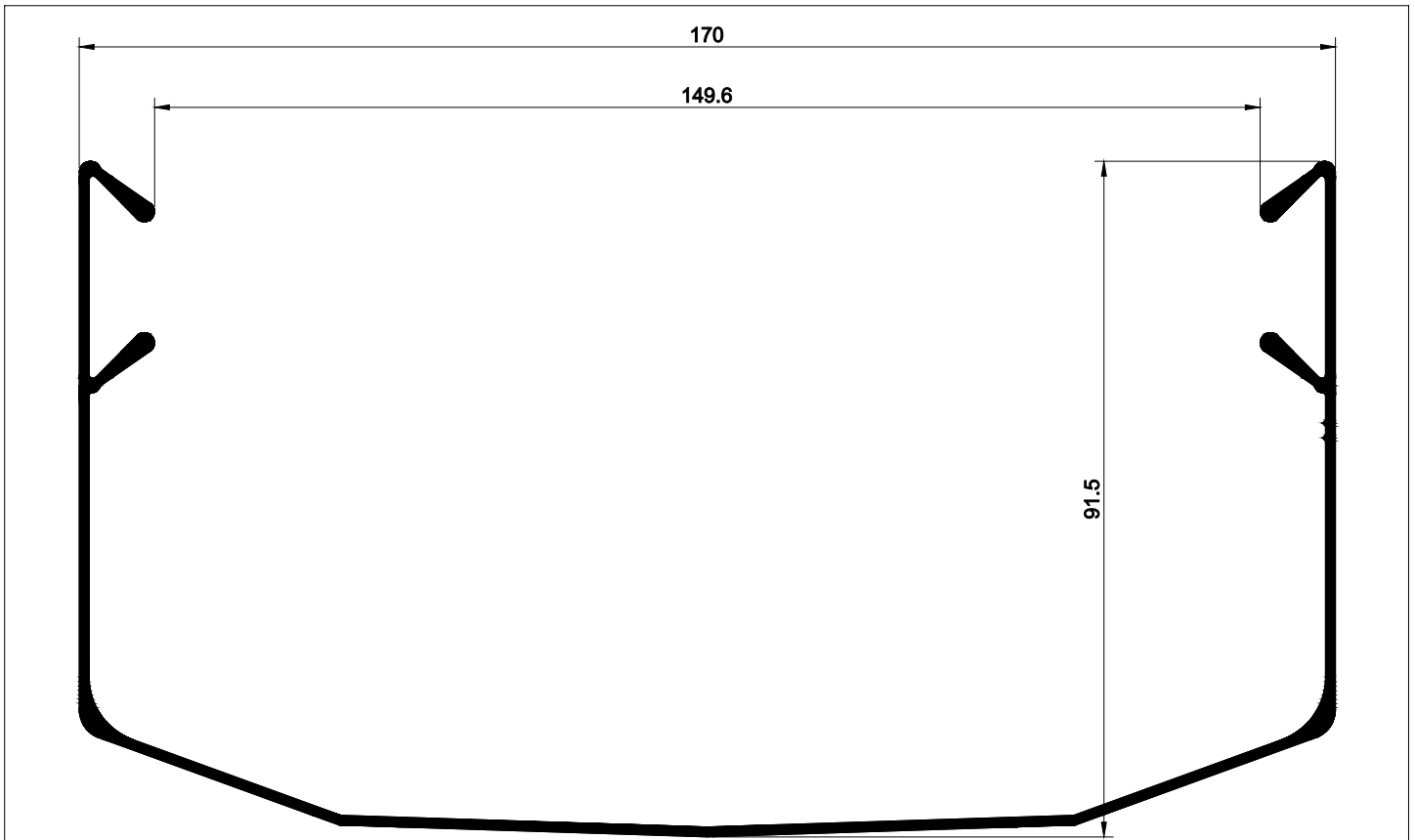

EDS-303
1,467 kg/m

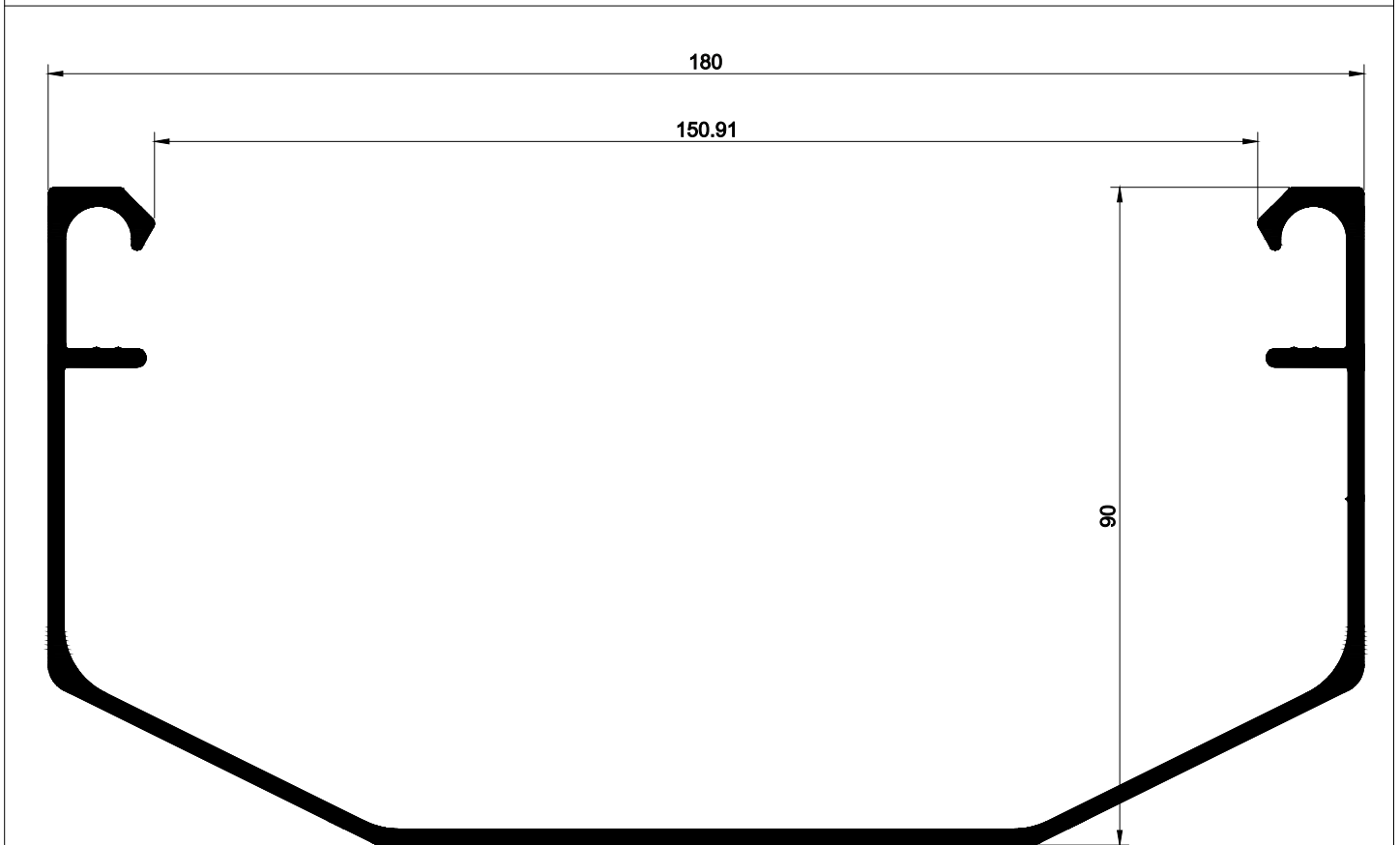

EDS-305
2,370 kg/m

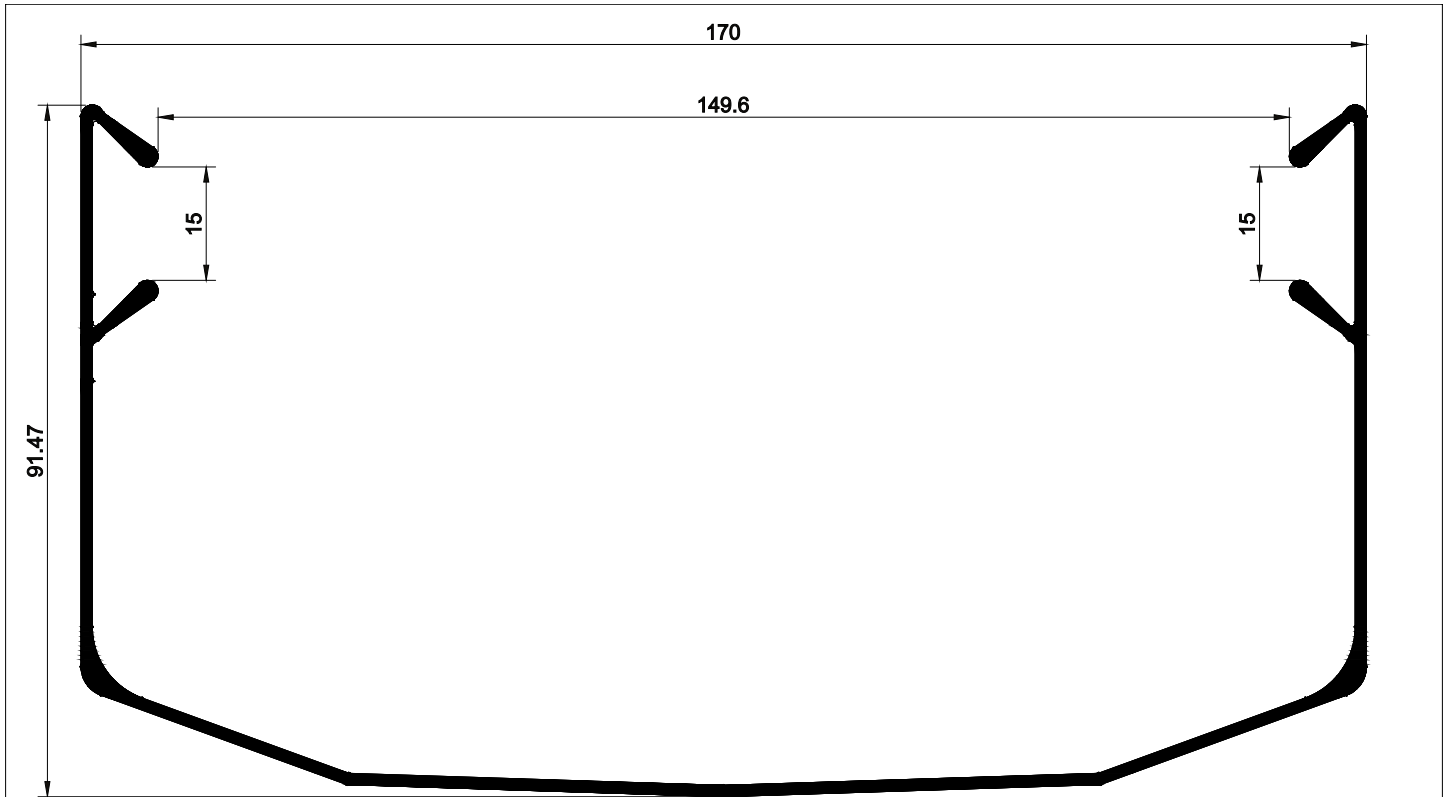

EDS-301
1,604 kg/m

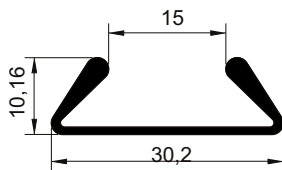

ELN-018
0,200 kg/m

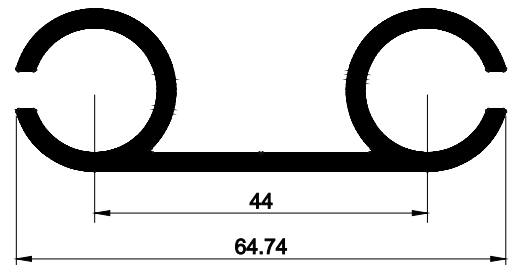

ELN-142
0,976 kg/m

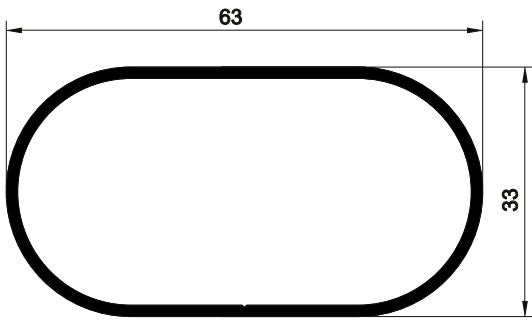

EMV-010
0,646 kg/m

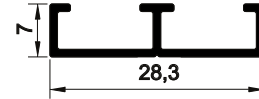

ELN-216
0,144 kg/m

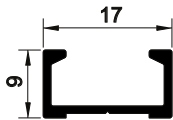

ELN-161
0,111 kg/m

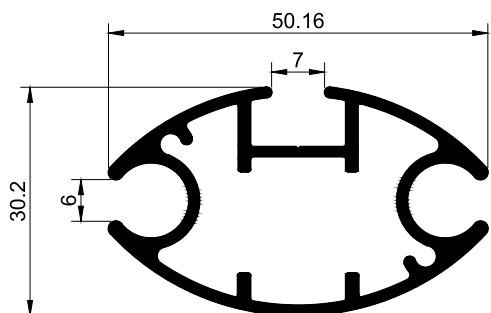

EPS-3454
0,780 kg/m

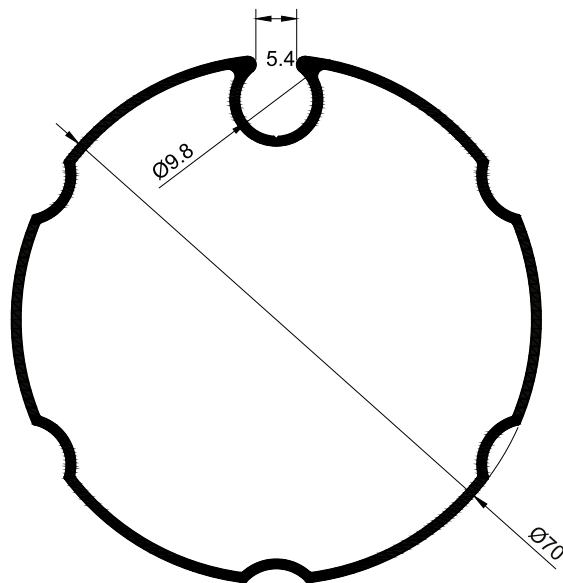

EPS-3782
0,794 kg/m

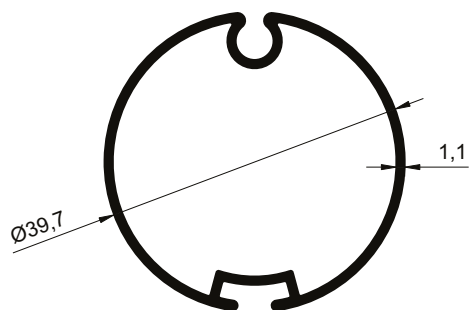

EPS-816
0,434 kg/m

COLUNA

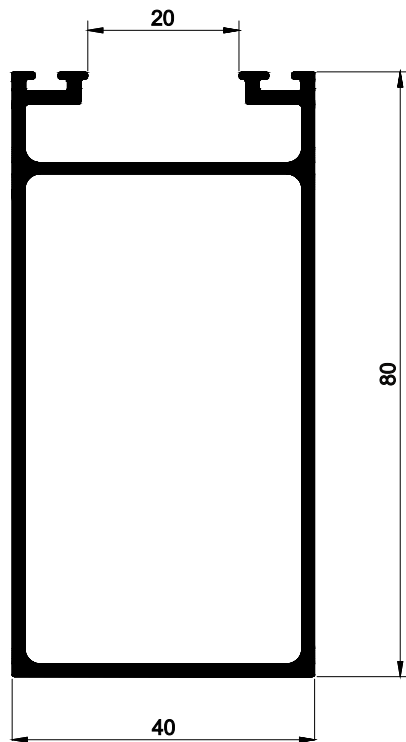

EFC-012
1,184 kg/m

COLUNA

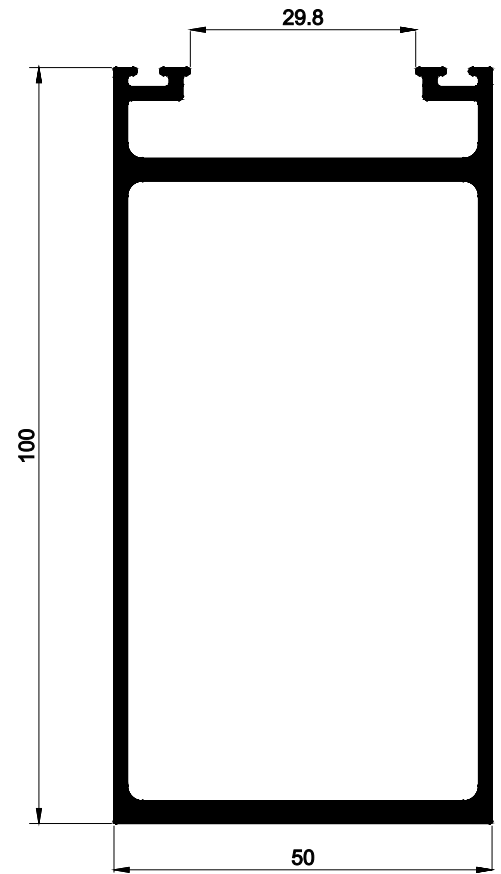

EFC-112
1,857 kg/m

ARREMATE 42mm

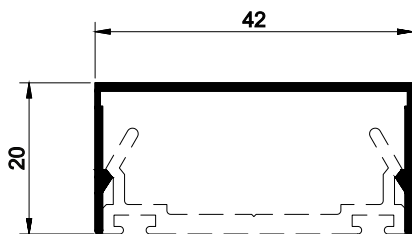

EFC-013
0,236 kg/m

TAMPA PARA ARREMATE 42mm

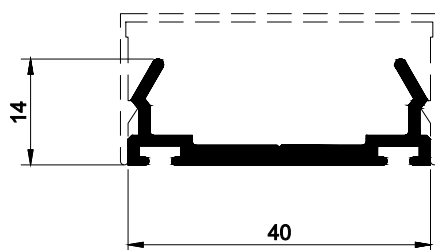

EFC-014
0,369 kg/m

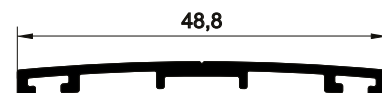

EPE-005
0,233 kg/m

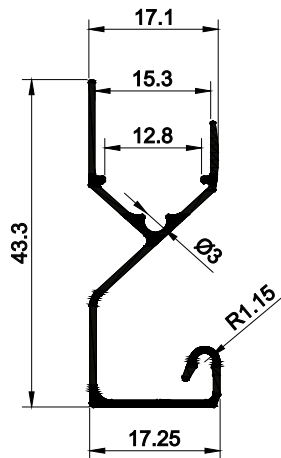

EMV-026

0,253 kg/m

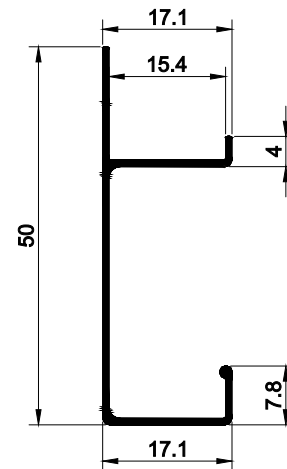

EMV-101

0,217 kg/m

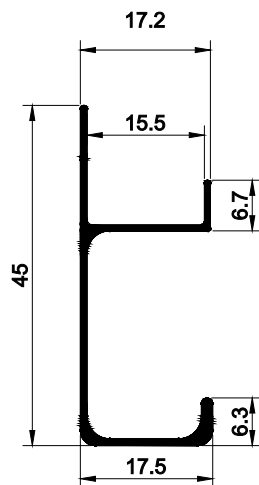

EMV-070

0,119 kg/m

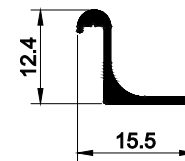

EMV-100

0,084 kg/m

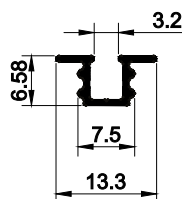

EMV-005

0,063 kg/m

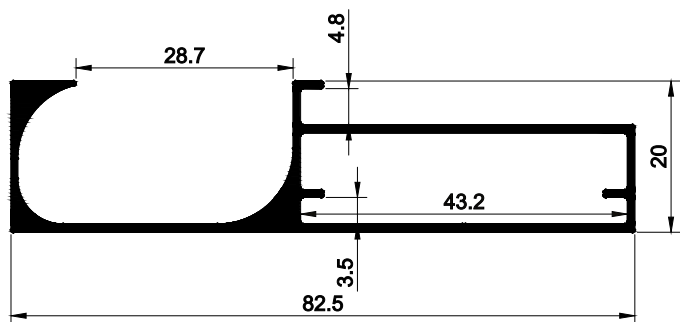

EMV-048
0,675 kg/m

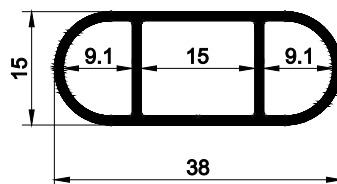

EMV-013
0,371 kg/m

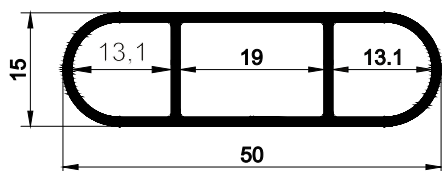

EMV-162
0,450 kg/m

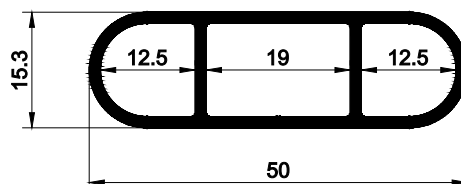

EMV-061
0,558 kg/m

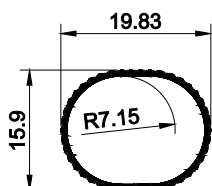

EMV-072
0,103 kg/m

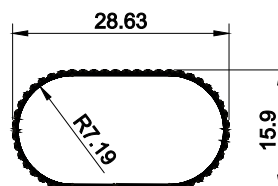

EMV-071
0,119 kg/m

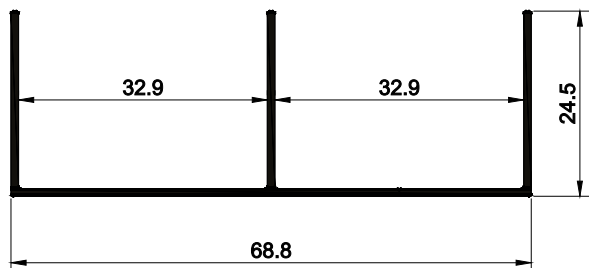

EMV-001
0,376 kg/m

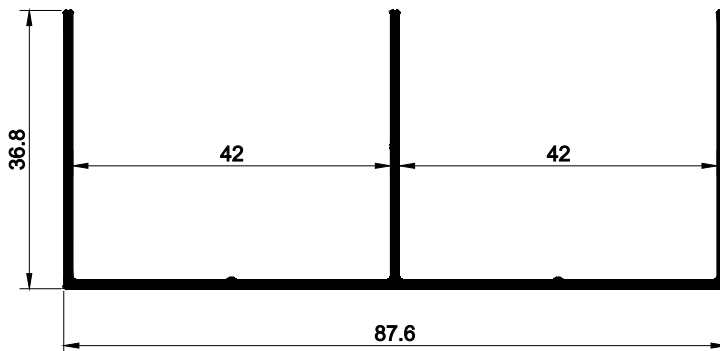

EMV-042
0,282 kg/m

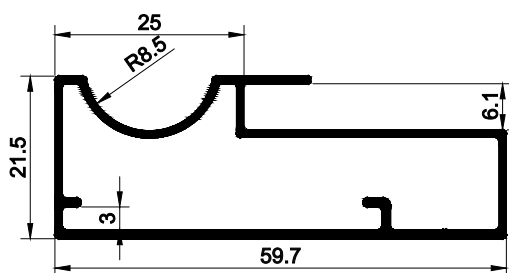

EMV-003
0,531 kg/m

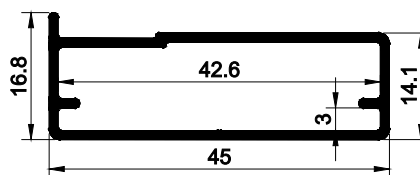

EMV-049
0,393 kg/m

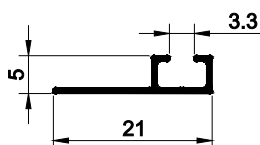

EMV-006
0,065 kg/m

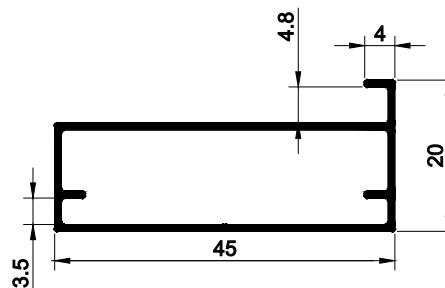

EMV-047
0,317 kg/m

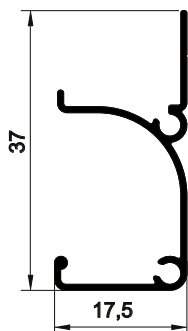

EMV-007
0,183 kg/m

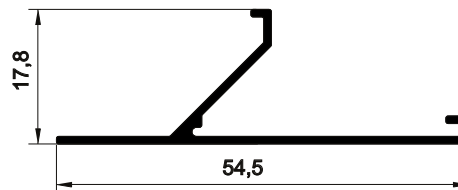

EMV-030
0,230 kg/m

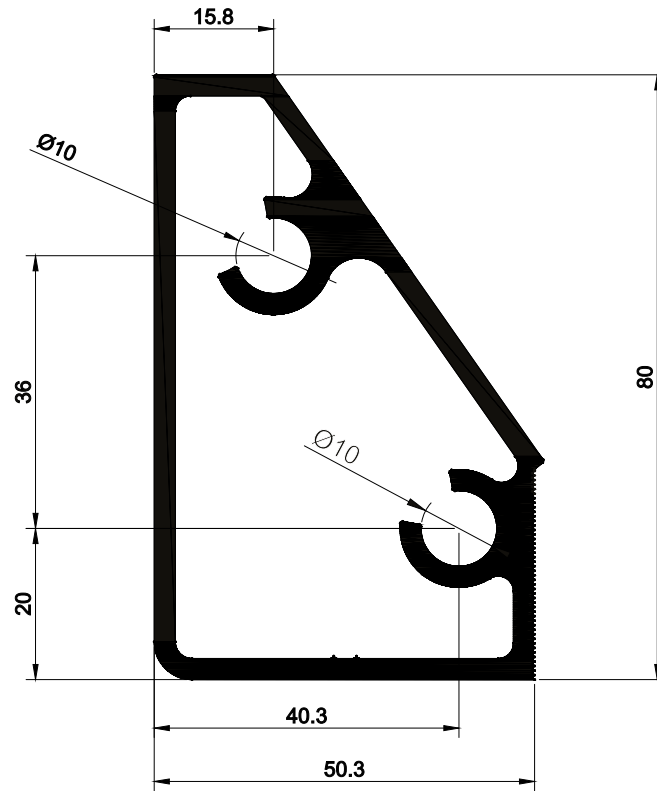

ESC-005
2,305 kg/m

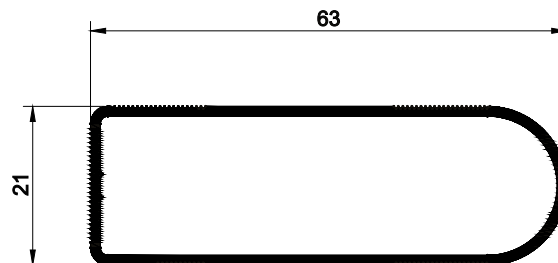

ESC-024
0,512 kg/m

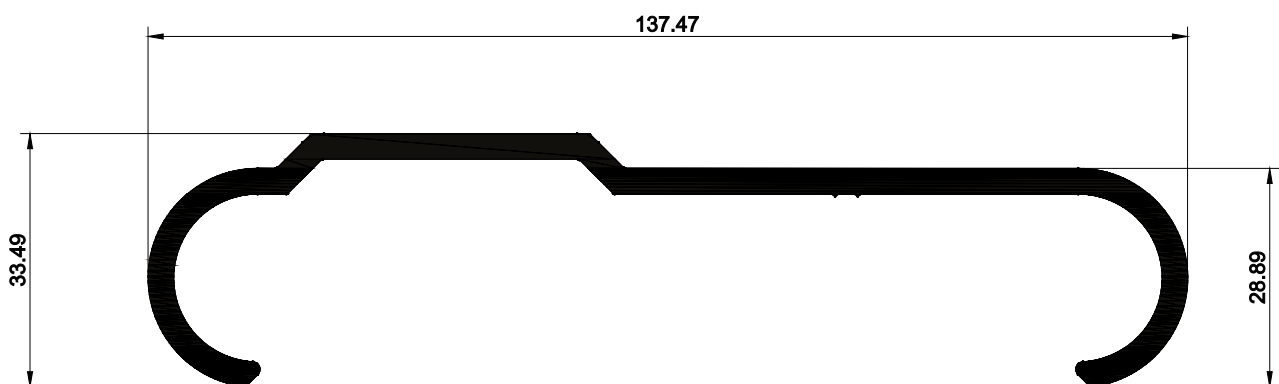

ESC-006
1,768 kg/m

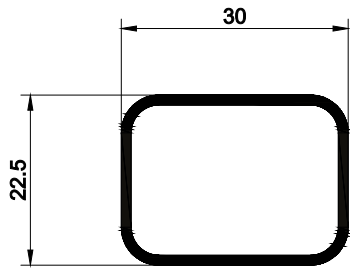

ESC-003
0,328 kg/m

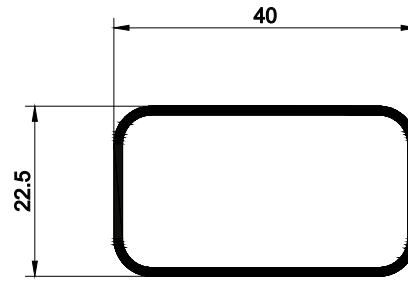

ESC-002
0,349 kg/m

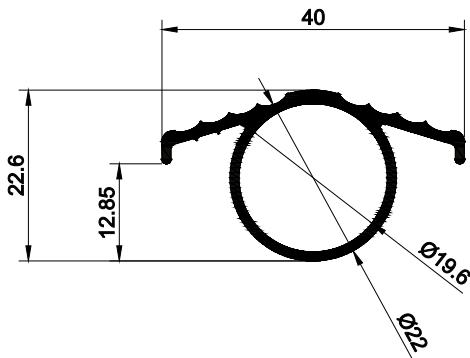

ESC-050
0,350 kg/m

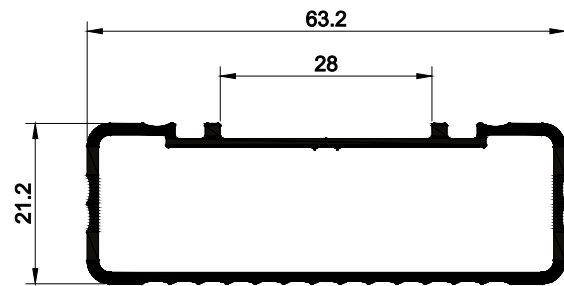

ESC-036
0,589 kg/m

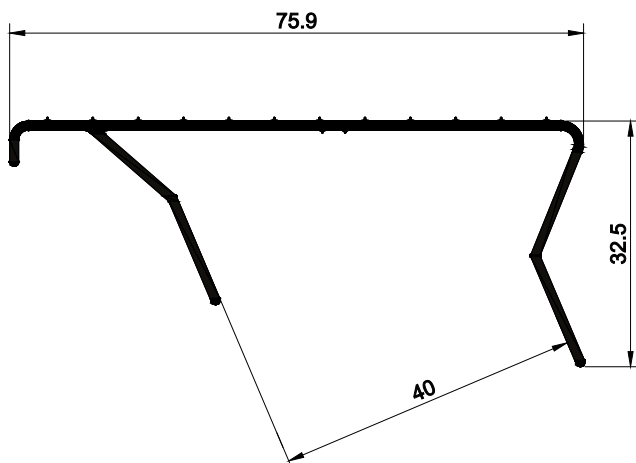

ESC-020
0,465 kg/m

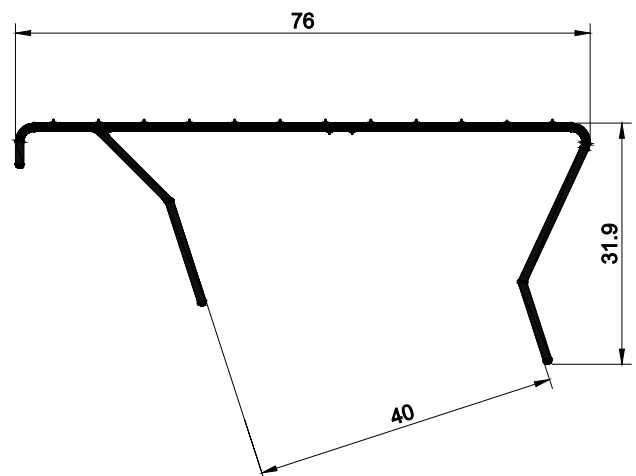

ESC-021
0,417 kg/m

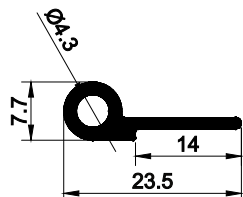

EAC-006
0,165 kg/m

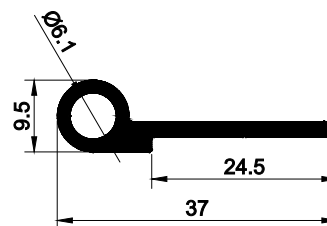

EAC-007
0,287 kg/m

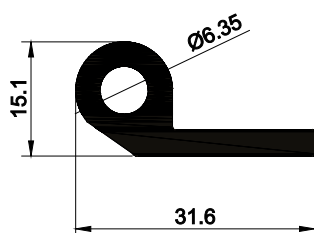

EAC-009
0,505 kg/m

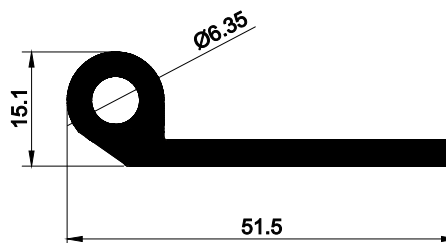

EAC-008
0,694 kg/m

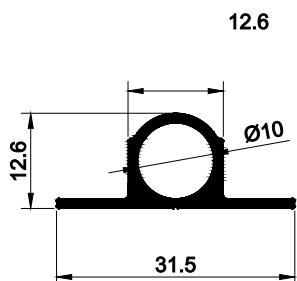

EAC-013
0,452 kg/m

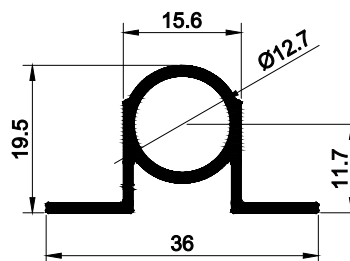

EAC-160
0,312 kg/m

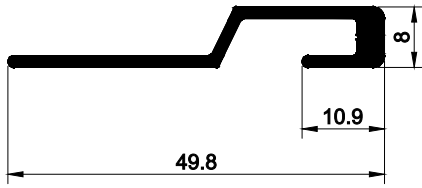

EAC-2029
0,317 kg/m

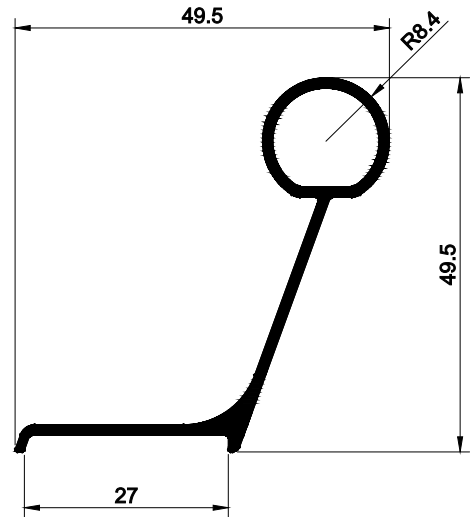

EAC-1468
0,458 kg/m

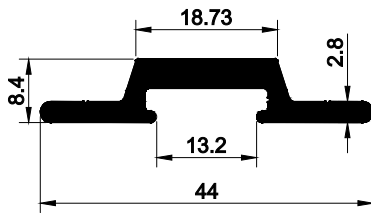

EAC-012
0,452 kg/m

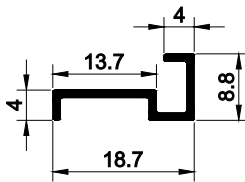

EAC-2027
0,458 kg/m

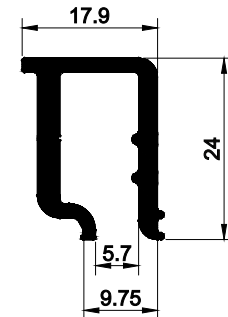

EAC-130
0,425 kg/m

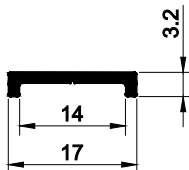

EAC-2030
0,078 kg/m

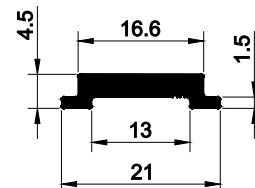

EAC-2028
0,166 kg/m

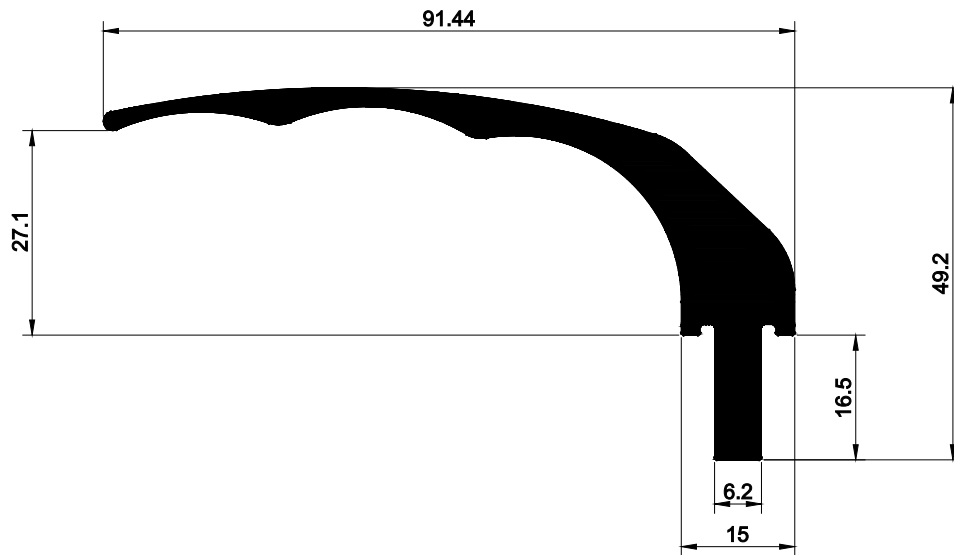

EAC-001
1,848 kg/m



EAC-011
2,147 kg/m

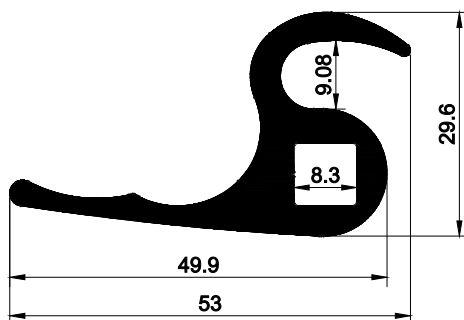

EAC-2057
1,067 kg/m

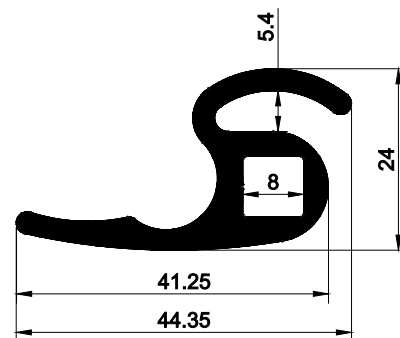

EAC-2056
0,807 kg/m

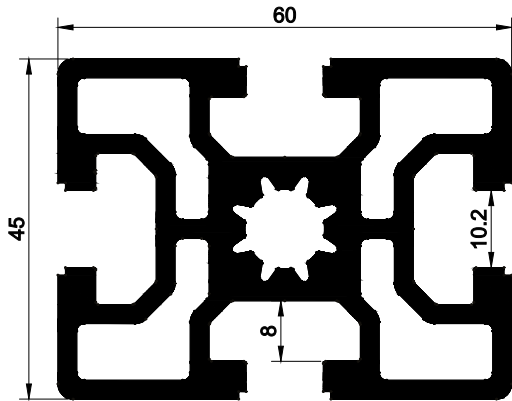

EDS-466
2,981 kg/m

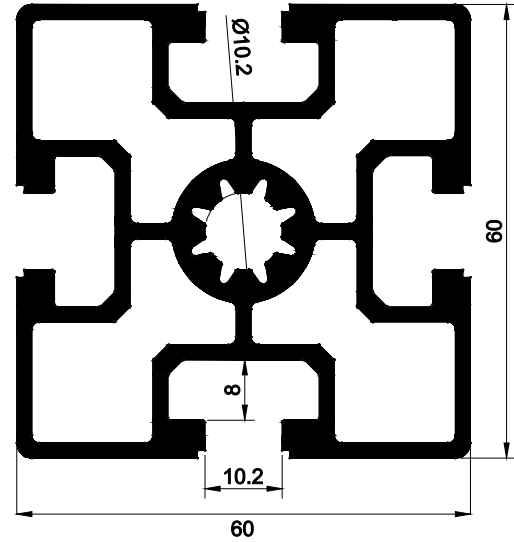

EDS-207
2,921 kg/m

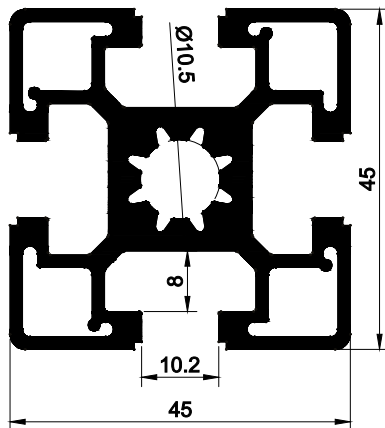

EDS-206
1,902 kg/m

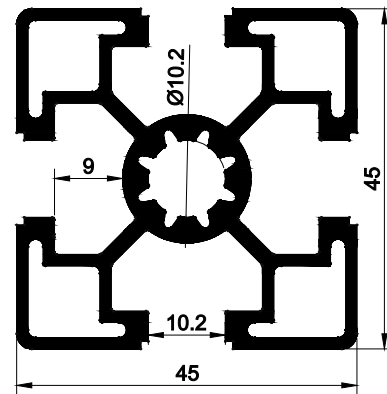

EDS-453
1,545 kg/m

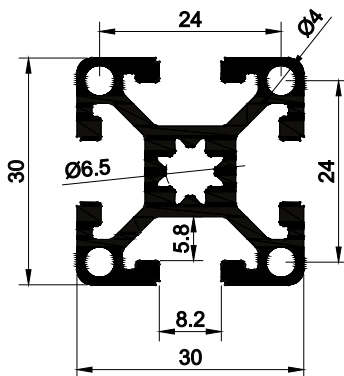

EDS-205
0,908 kg/m

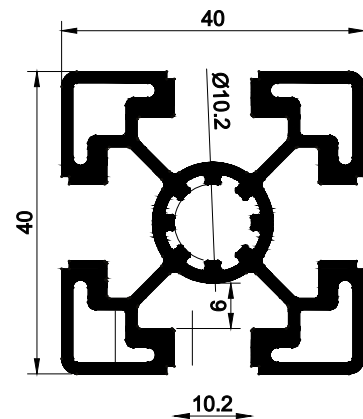

EDS-365
1,349 kg/m

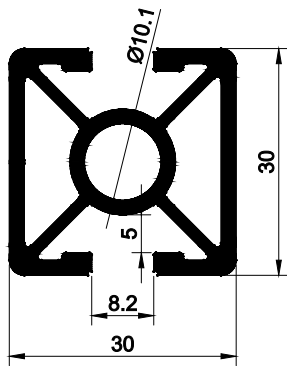

EDS-726
0,935 kg/m

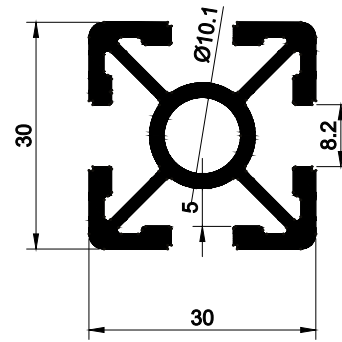

EDS-727
0,886 kg/m

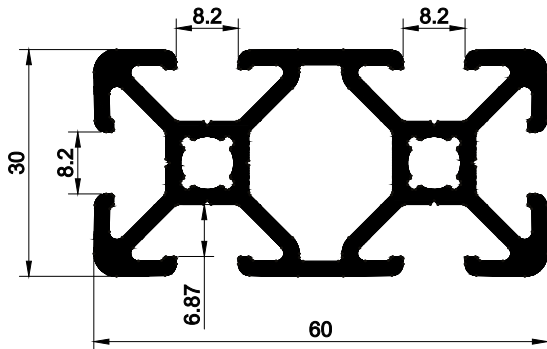

EDS-828
1,550 kg/m

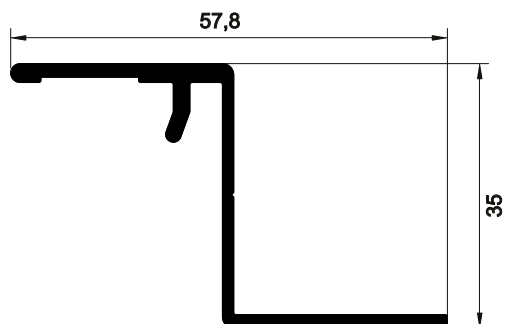

EIR-007
0,486 kg/m

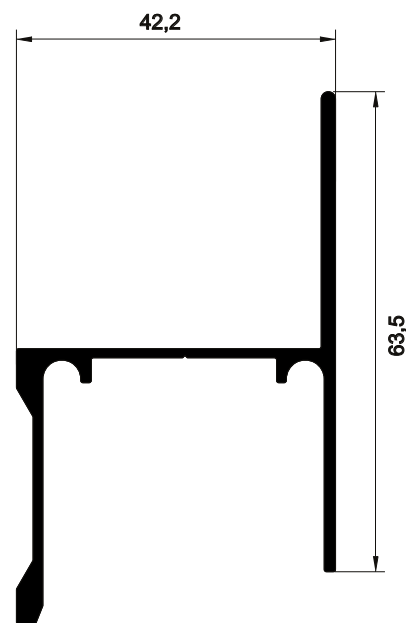

EIR-008
0,668 kg/m

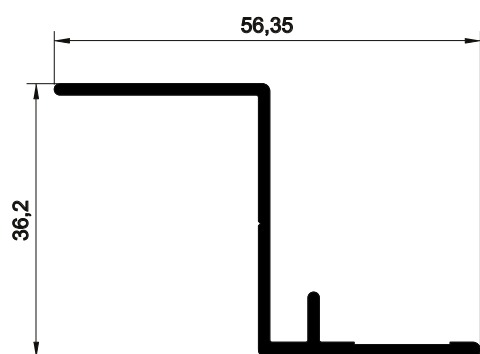

EIR-009
0,421 kg/m

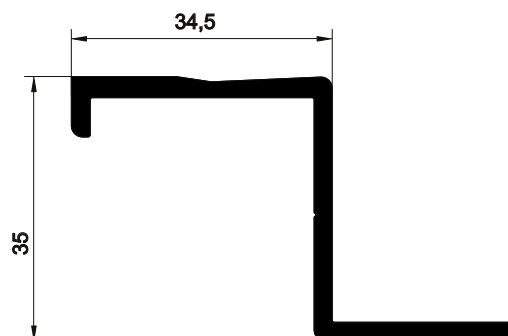

EIR-010
0,646 kg/m



EIR-011
0,229 kg/m

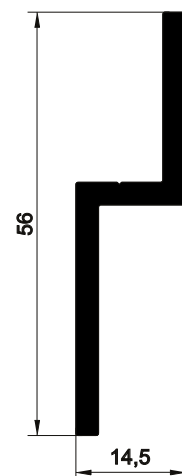

EIR-012
0,548 kg/m

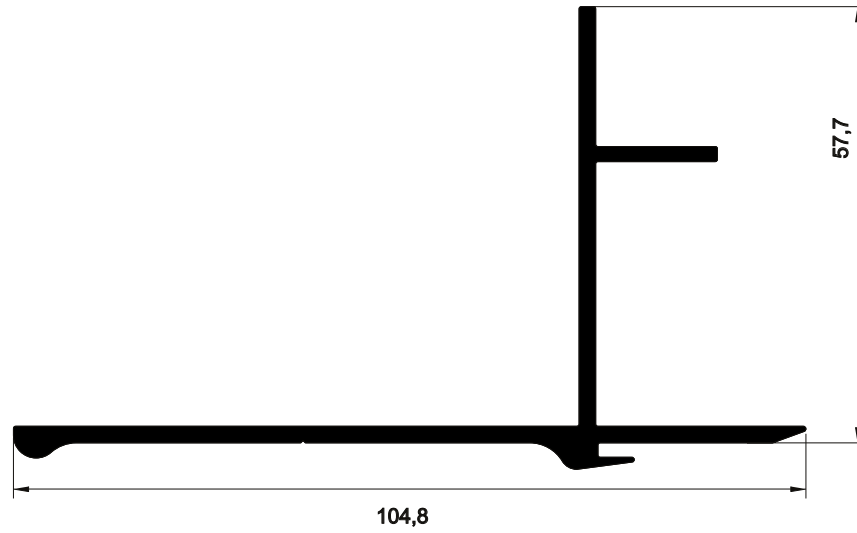

EIR-004
1,119 kg/m

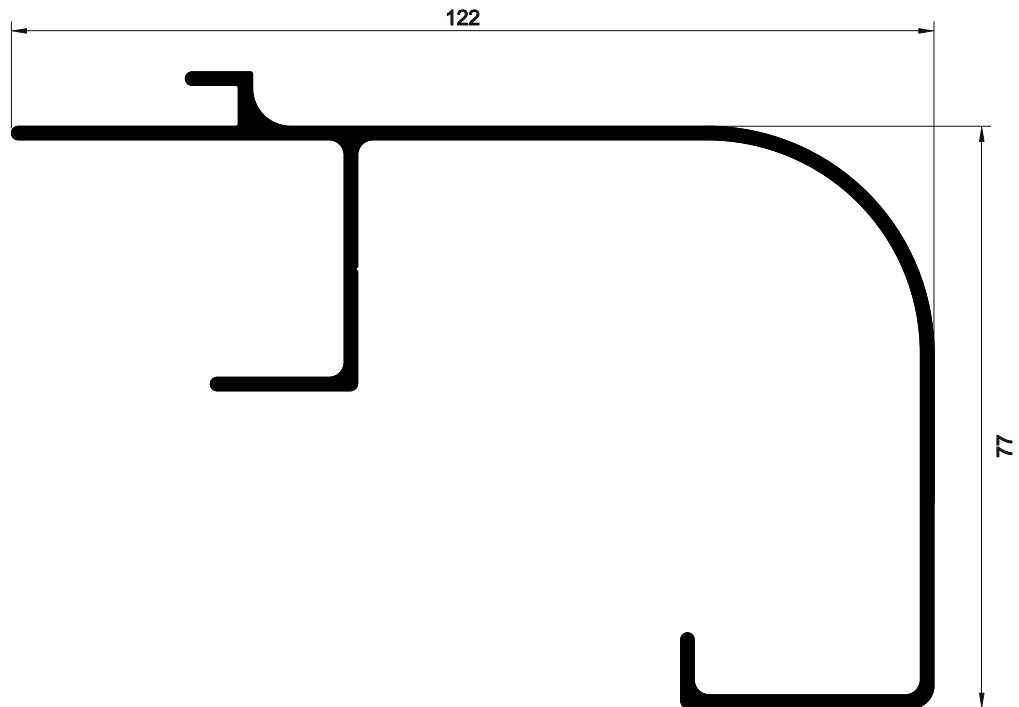

EIR-005
1,431 kg/m

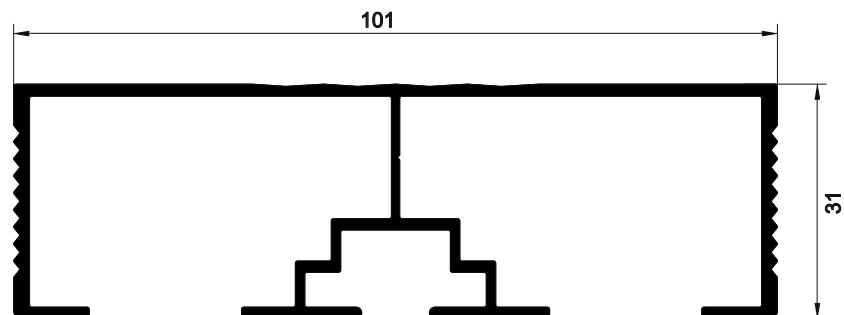

EIR-006
1,130 kg/m

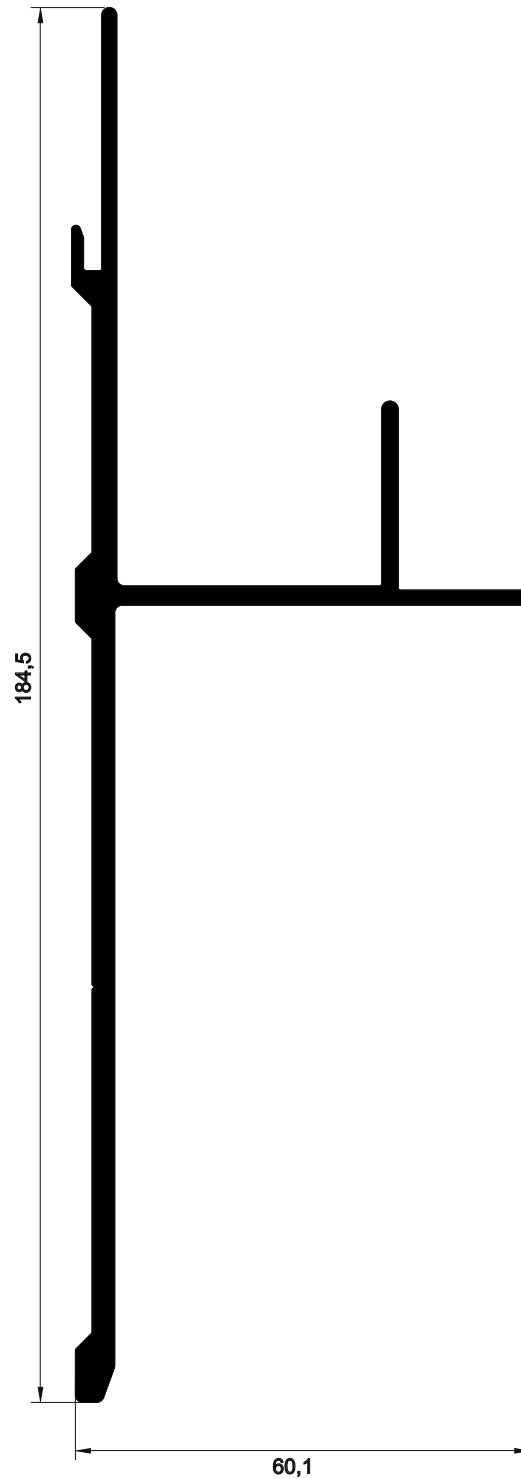

EIR-015
2,075 kg/m

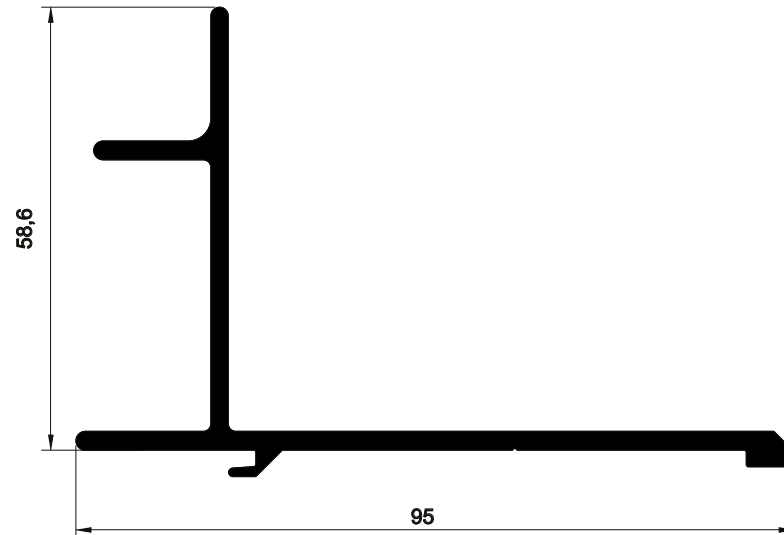

EIR-001
1,156 kg/m

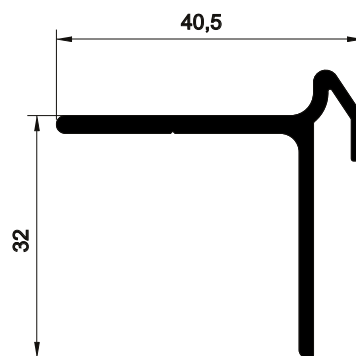

EIR-002
0,454 kg/m

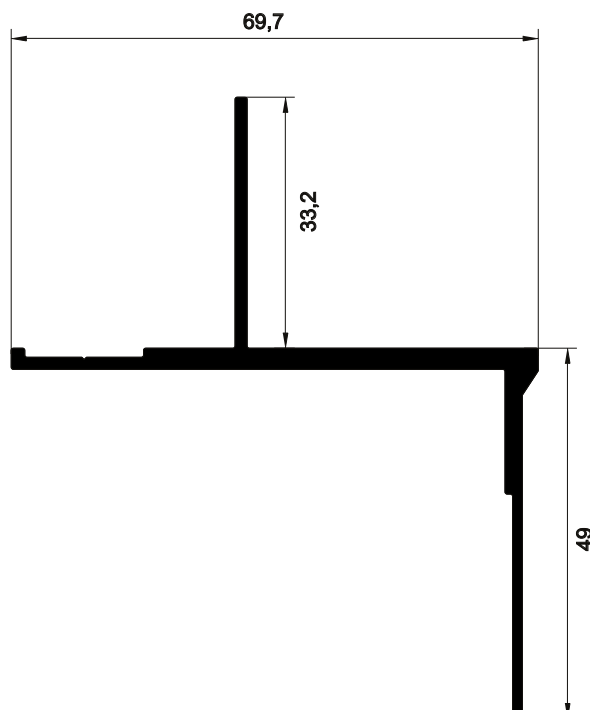

EIR-003
0,839 kg/m

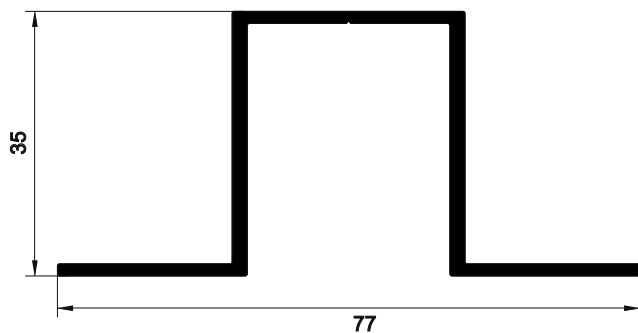

EIR-013
0,695 kg/m

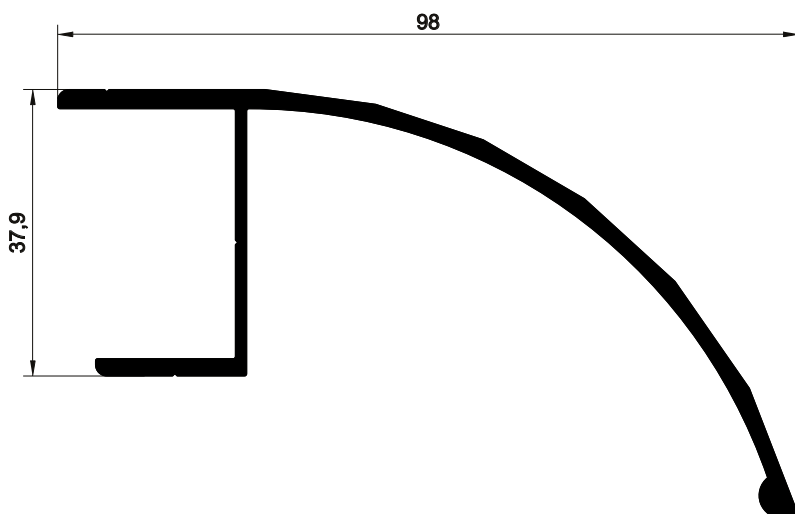

EIR-014
1,044 kg/m

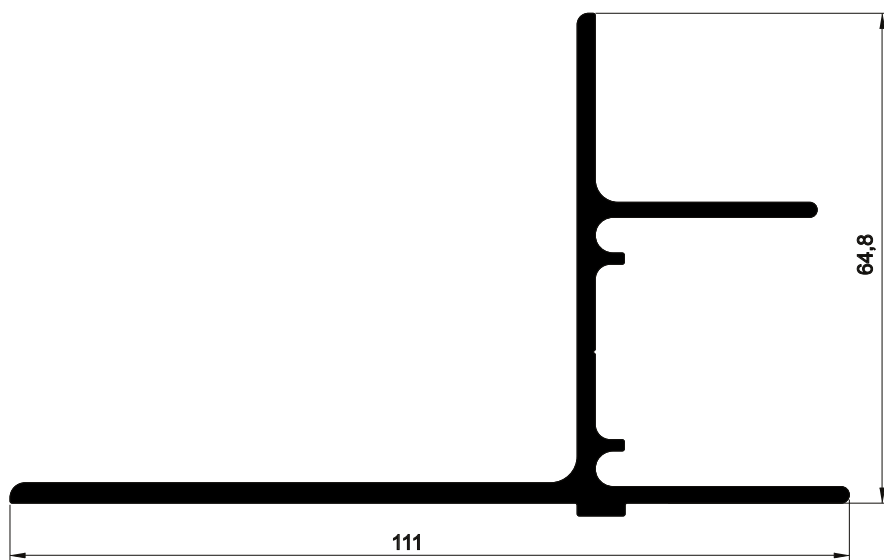

EIR-016
0,668 kg/m

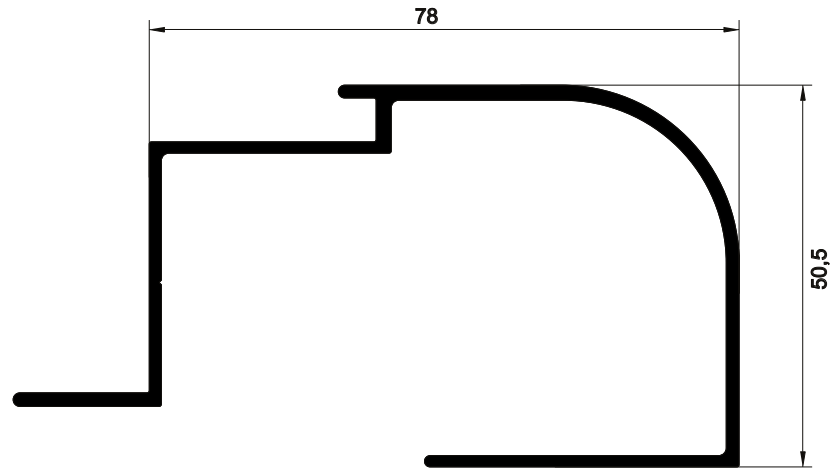

EIR-022
1,008 kg/m

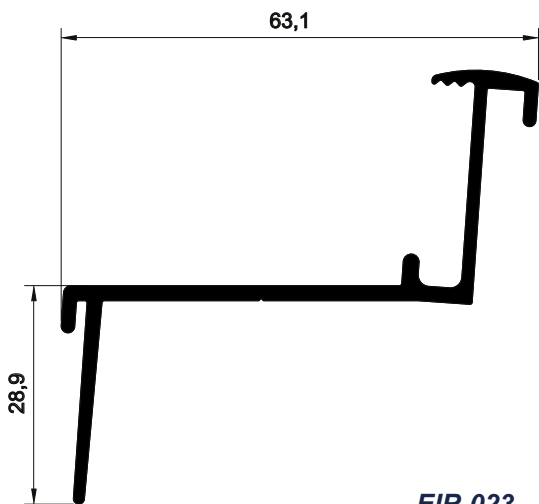

EIR-023
0,667 kg/m

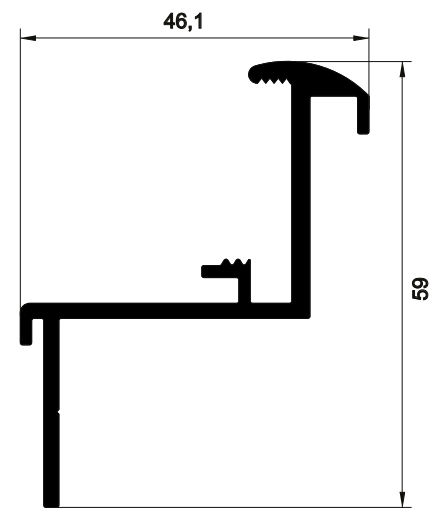

EIR-024
0,722 kg/m

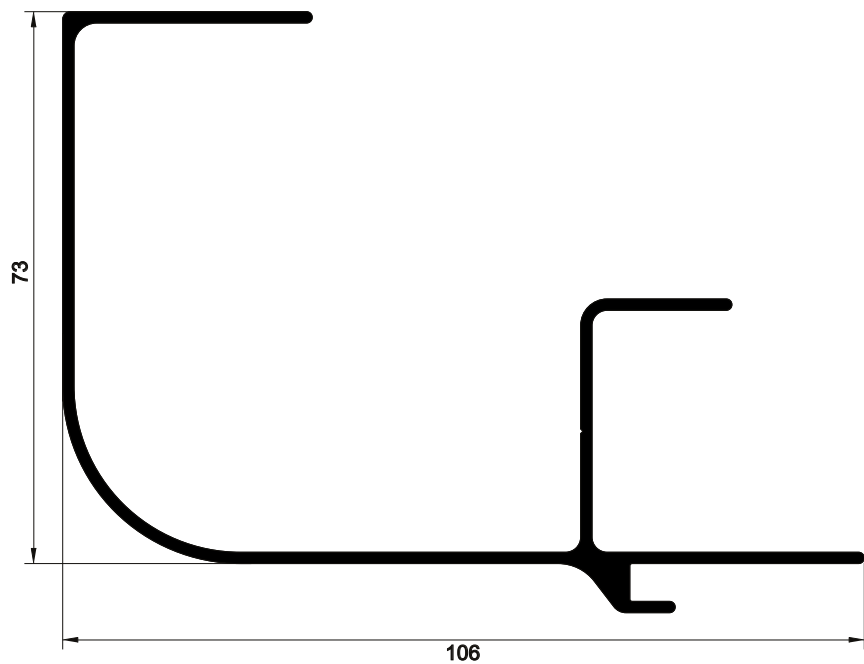

EIR-025
1,121 kg/m

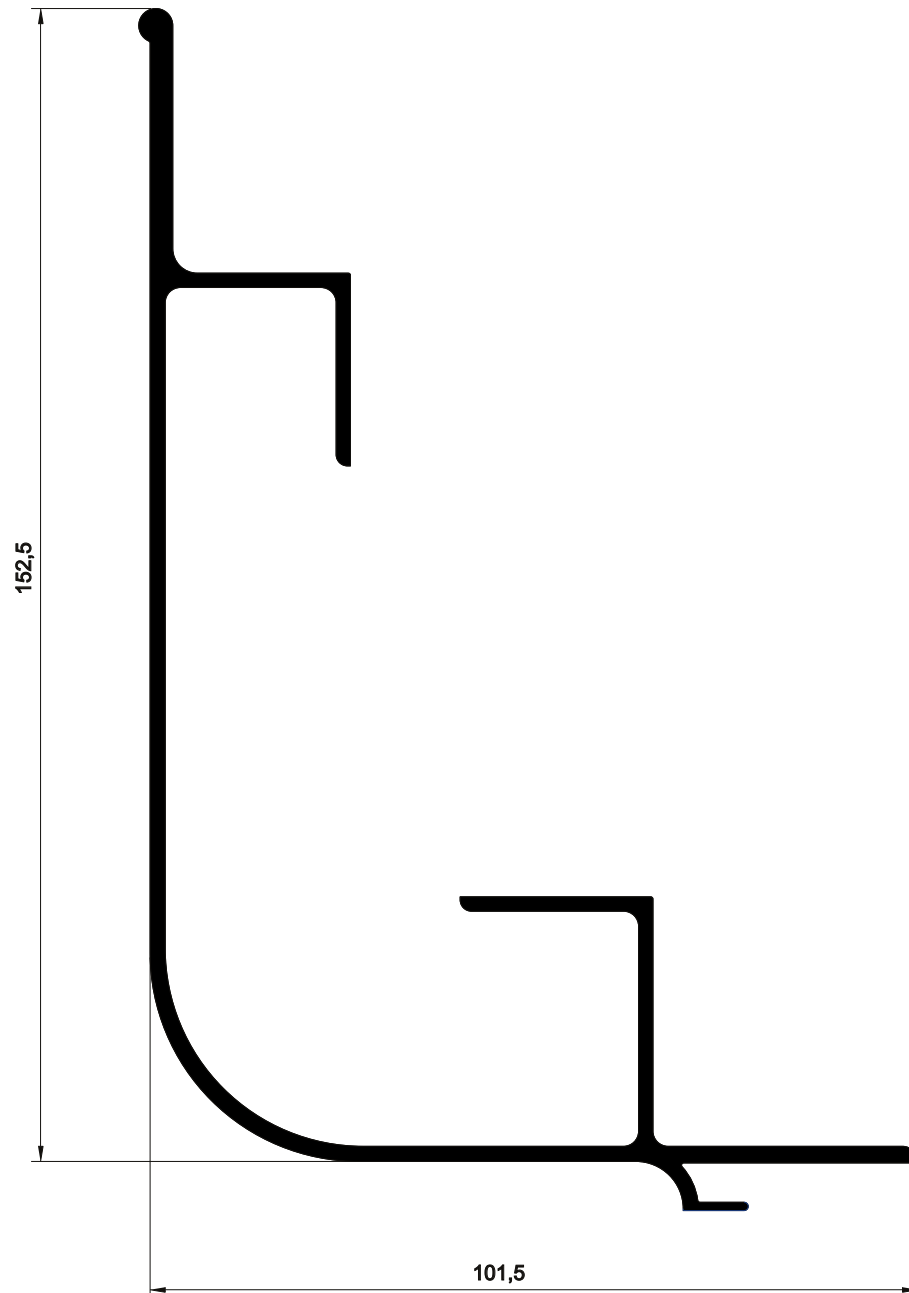

EIR-020
2,058 kg/m

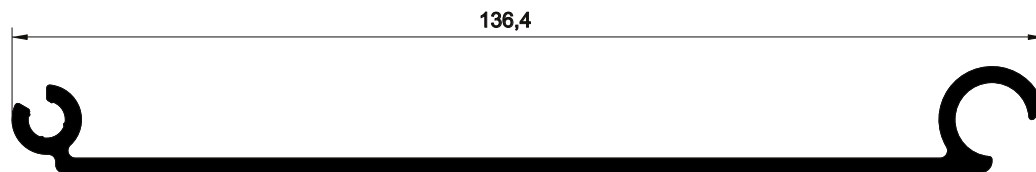

EIR-029
0,889 kg/m

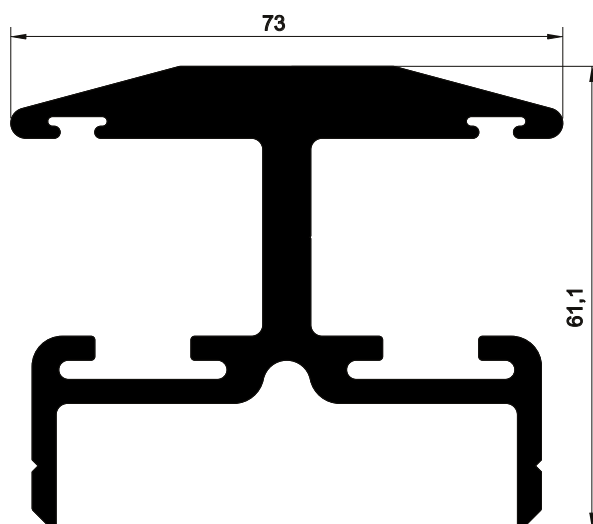

EIR-030
3,124 kg/m

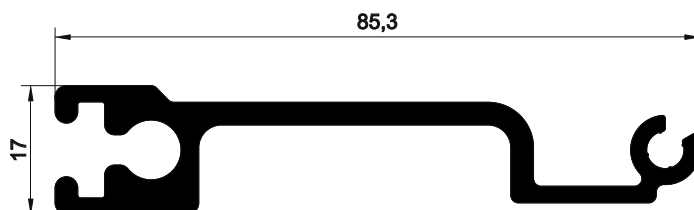

EIR-031
1,137 kg/m

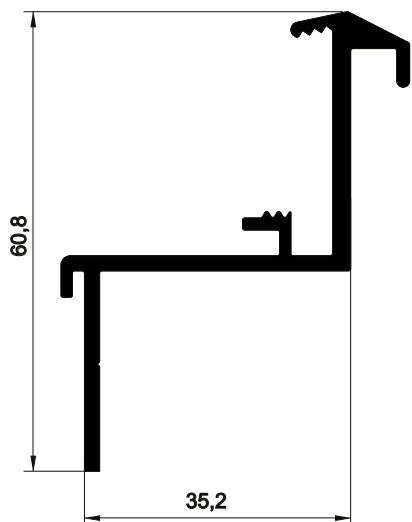

EIR-026
0,724 kg/m

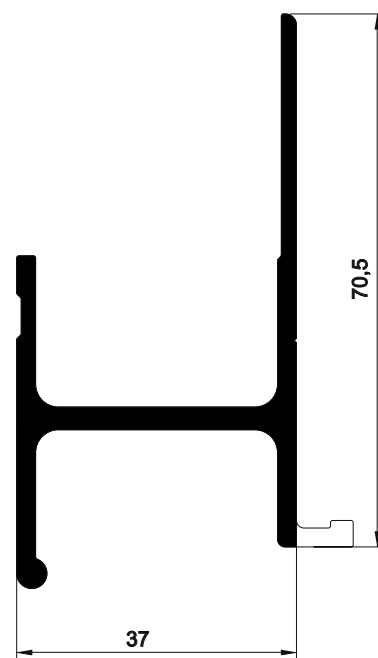

EIR-028
1,071 kg/m

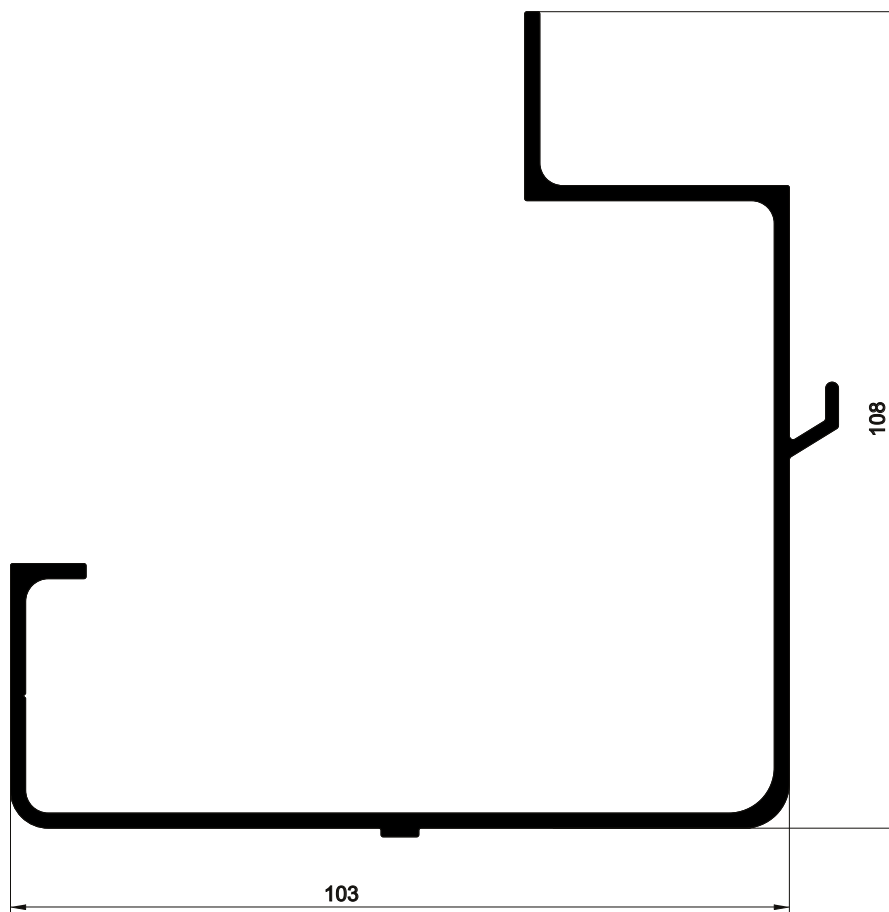

EIR-027
1,611 kg/m

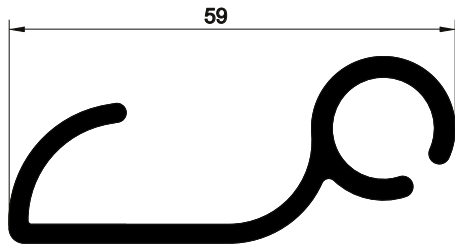

EIR-039
0,808 kg/m

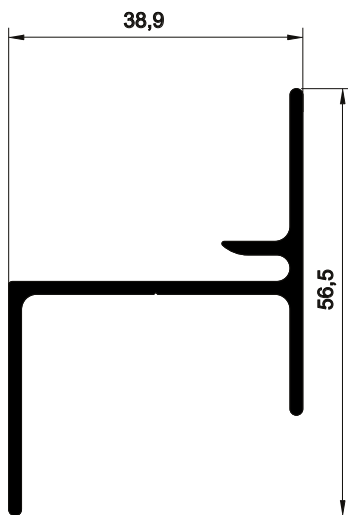

EIR-041
0,552 kg/m

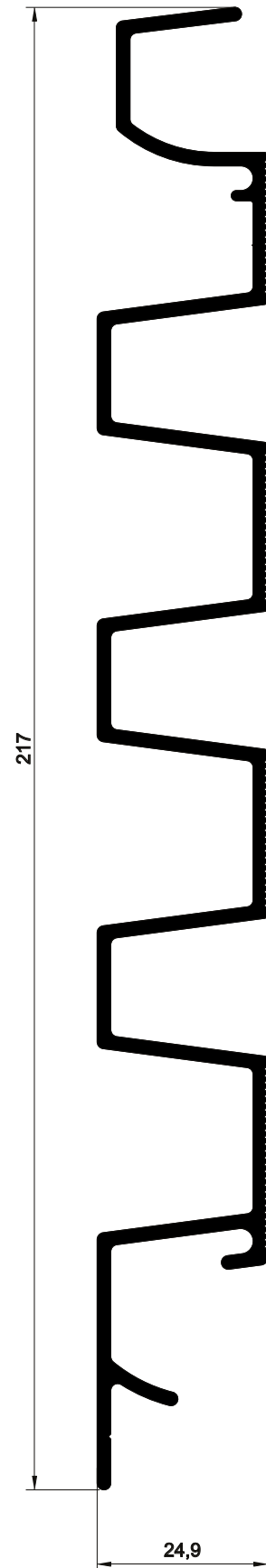

EIR-040
2,202 kg/m

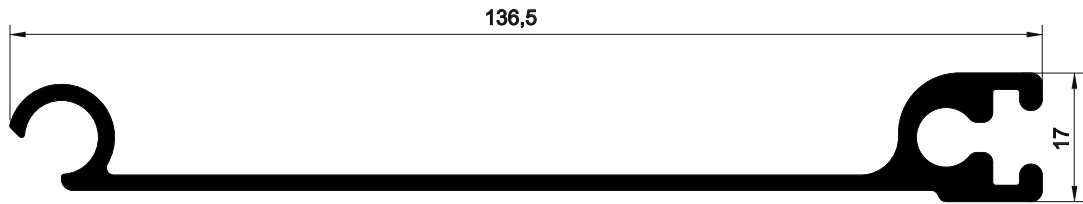

EIR-032
1,221 kg/m

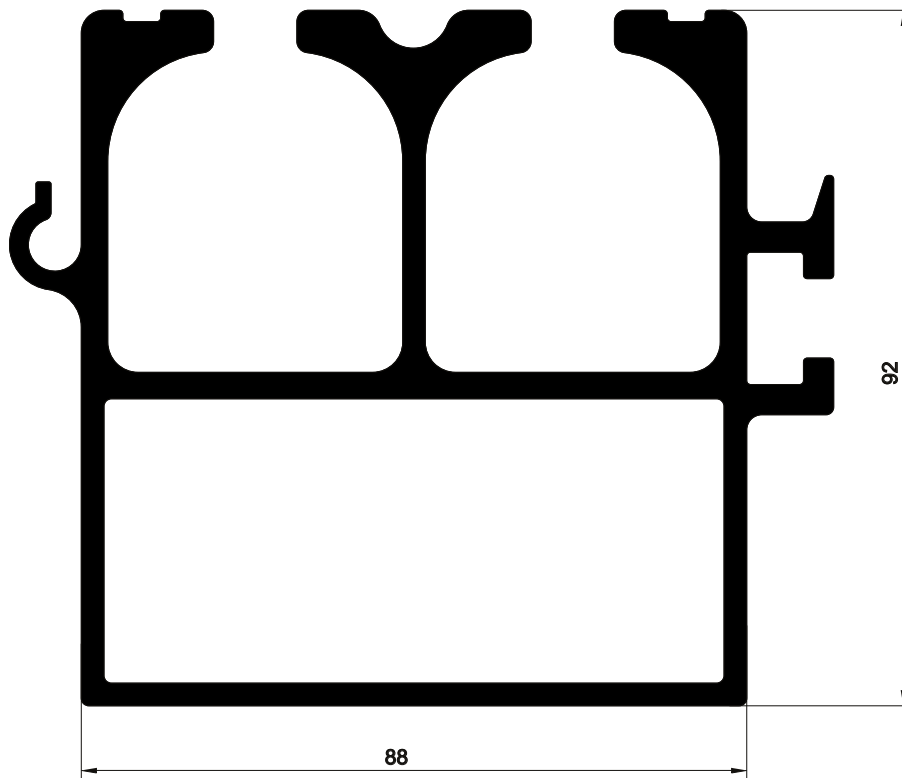

EIR-033
5,166 kg/m

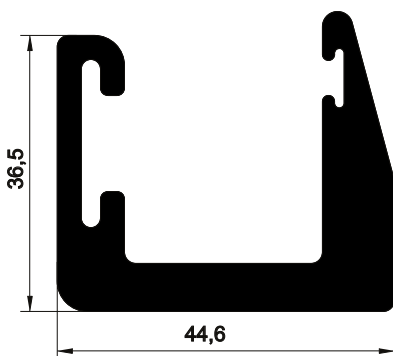

EIR-034
1,841 kg/m

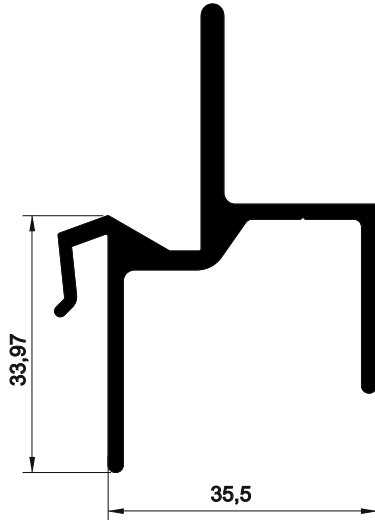

EIR-017
0,894 kg/m

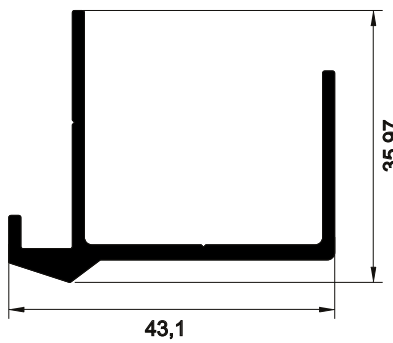

EIR-018
0,528 kg/m

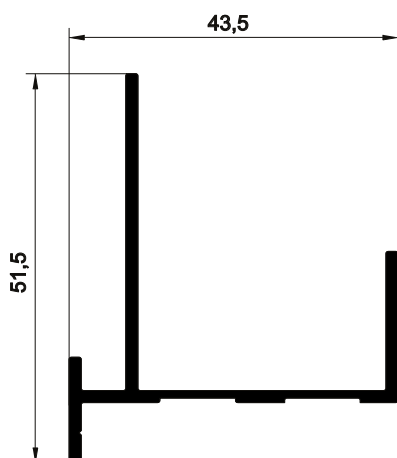

EIR-019
0,528 kg/m

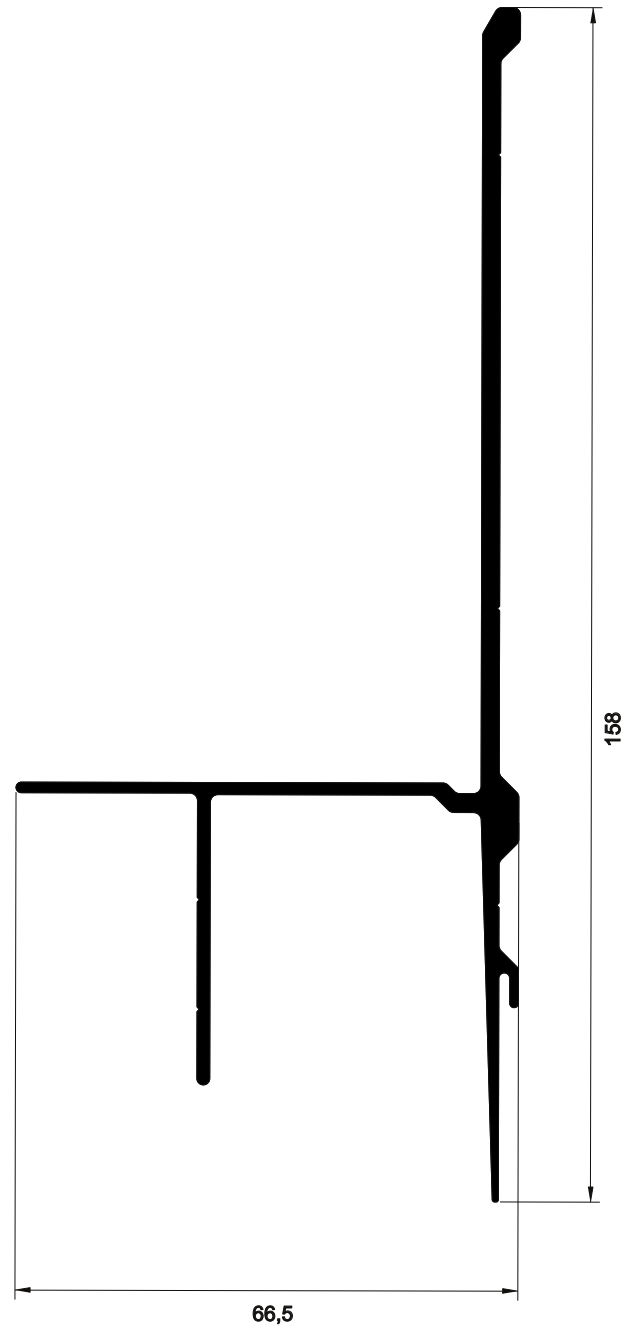

EIR-021
1,484 kg/m

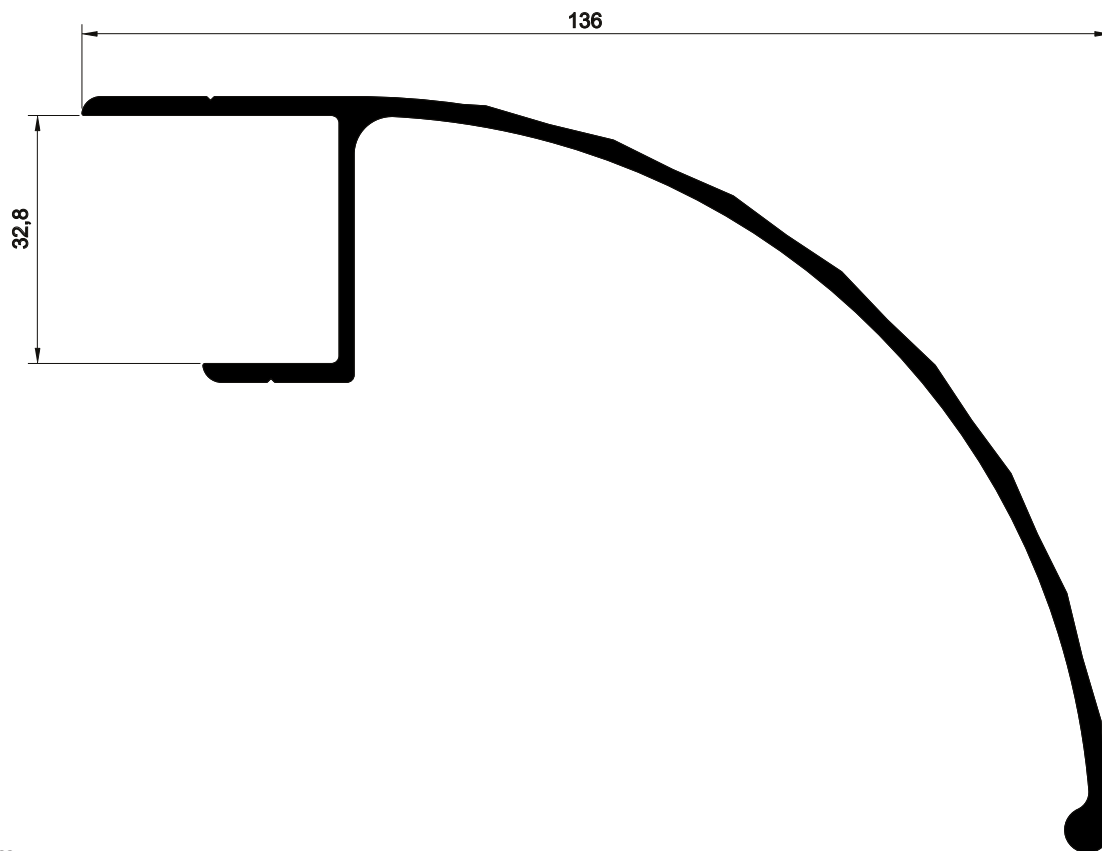

EIR-035
1,640 kg/m

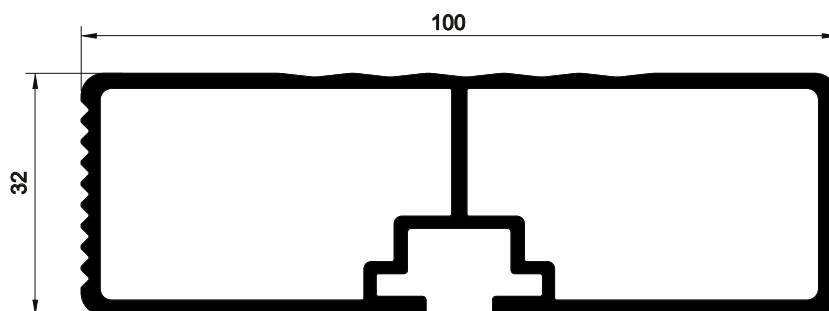

EIR-036
1,602 kg/m

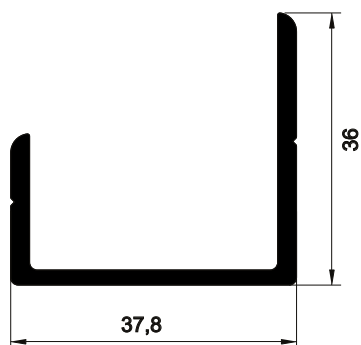

EIR-037
0,548 kg/m

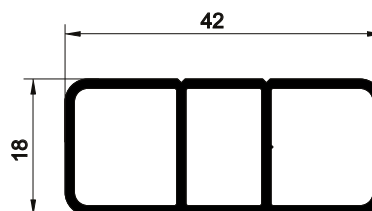

EIR-038
0,478 kg/m

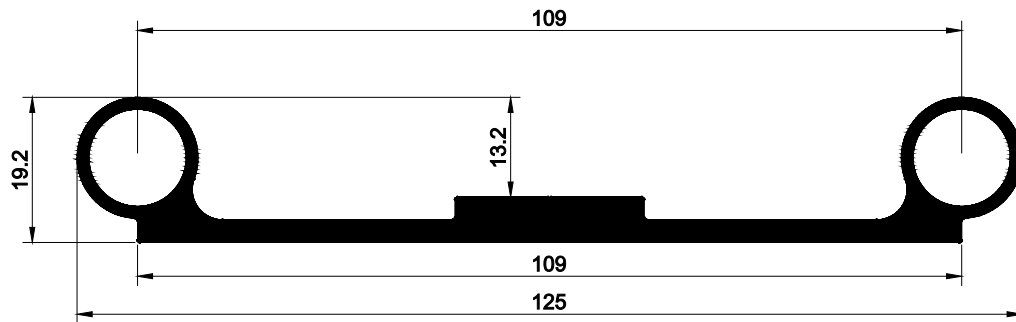

EDS-011
1,555 kg/m

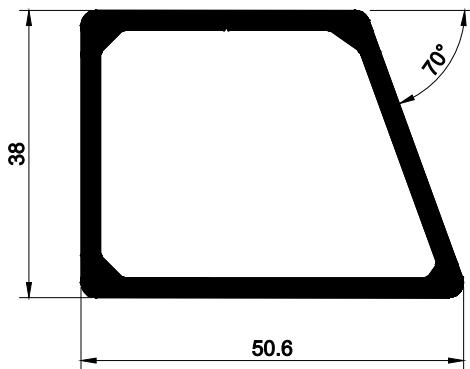

EDS-1378
1,135 kg/m

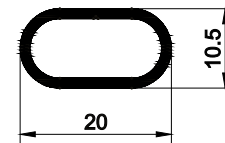

EDS-221
0,168 kg/m

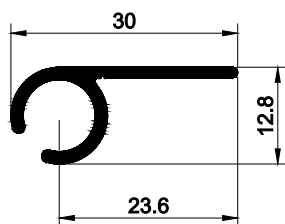

EDS-590
0,217 kg/m

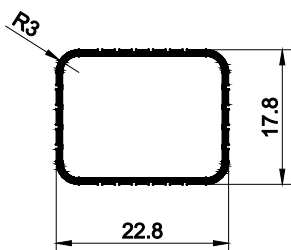

EFL-001
0,160 kg/m

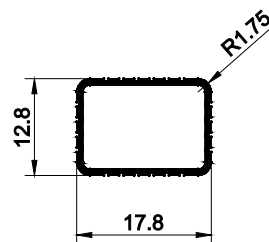

EFL-002
0,119 kg/m

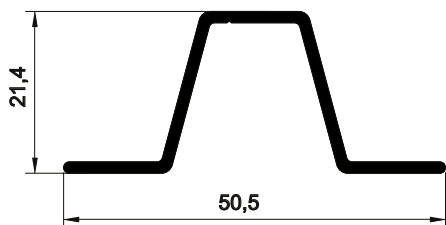

EDS-781
0,325 kg/m

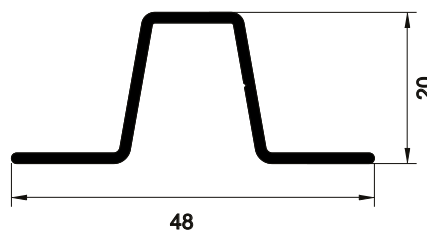

EDS-766
0,431 kg/m

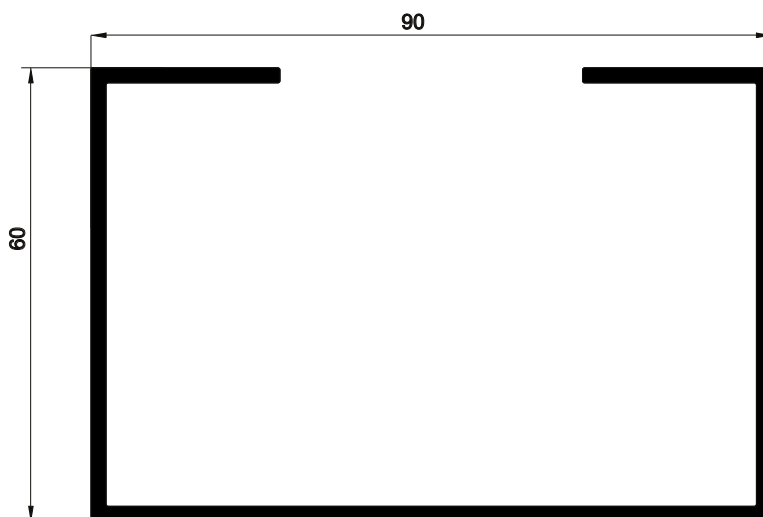

ELN-284
1,365 kg/m

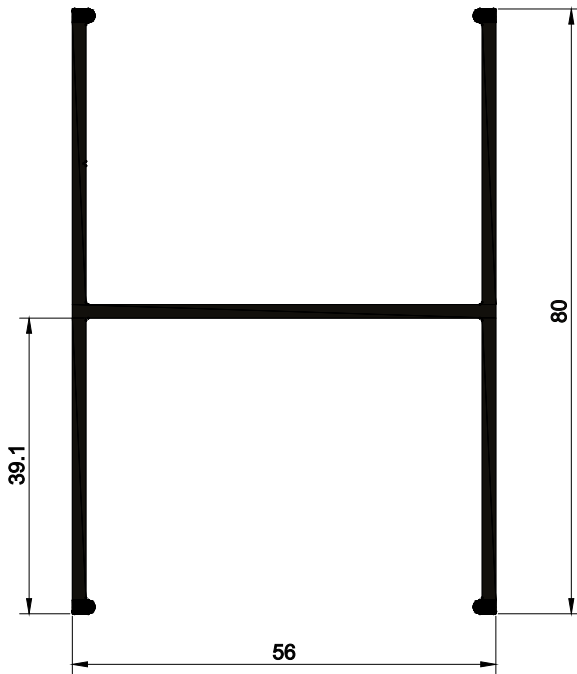

EDS-477
1,057 kg/m

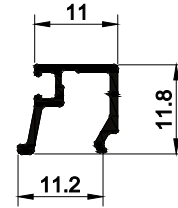

EBG-001
0,103 kg/m

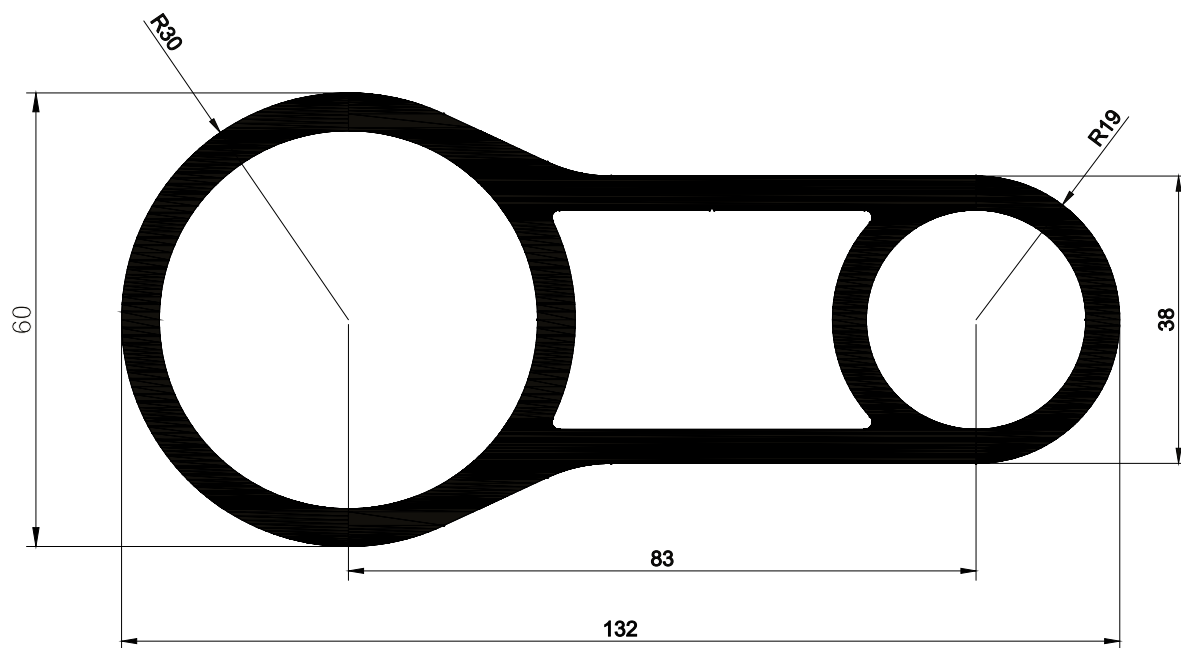

EDS-994
4,987 kg/m

SOLUÇÕES

Soluções de grande complexidade, extrema precisão e tolerâncias dimensionais. Para obter resultados positivos é fundamental possuir como base para o desenvolvimento das atividades um local apropriado que atenda a todas as necessidades tanto dos profissionais como dos produtos a serem desenvolvidos e aperfeiçoados. Todo o processo de extrusão da empresa é 100% rastreado e supervisionado, desde o corte da matéria-prima (o tarugo), até a embalagem dos perfis já extrudados.



✉ contato@extrutech.com.br

☎ (11) 2600-1638

🏠 Rua João Ranieri, 1290 - Jd. Fátima
Guarulhos - SP - CEP: 07177-120



extrutech alumínio

www.extrutech.com.br